

Section 1 Introduction

In the event of an emergency, the most important thing is to first secure one's personal safety. Activities to rescue and secure the safety of those around you and to prevent the spread of damage must be undertaken only after you have secured your personal safety and confirmed that you are not in danger. Protecting your personal safety is important to minimize damage.

This chapter summarizes the general measures to be taken in the event of an emergency. In addition to the individual topics discussed in Chapter 4 and below, those of particular importance and should be implemented immediately are provided. We urge you to review this information when an emergency occurs, and to read it in advance to be prepared to respond promptly and to the best of your ability in the event of an emergency.

Section 2 Specific Measures

1 Safety basics

As a basic safety precaution, the following precautions should be taken regularly:

- (1) Always keep the laboratory space tidy, neat, and clean.
- (2) Wear appropriate clothing and footwear for the work.
- (3) Use protective equipment (helmets, safety glasses, gloves, masks, etc.) appropriate for the work.
- (4) Work in a stable posture appropriate for the work.
- (5) Be aware that arbitrary or hasty decisions can result in injury.
- (6) When working in the same posture for a long time, it is also important to eliminate static fatigue.

2 If an electrical accident occurs

[In case of electrocution]

- (1) Turn off the power to the main unit using the "emergency stop switch". Alternatively, turn off the breaker of the experiment panel.
- (2) If it is not possible to turn off the breaker, use a dry stick, cloth, insulated rubber gloves, etc. to pull the person requiring rescue away from the site of electric shock to prevent the rescuer from receiving an electric shock.
- (3) In case of cardiopulmonary arrest or shallow breathing, call an ambulance while performing a cardiac massage and artificial respiration (for cardiac massage and artificial respiration, refer to pp. 10–11).
- (4) Keep the target warm and at rest.

3 If you notice a gas leak

- (1) Open doors and windows.
- (2) Close gas cocks and main valves.
- (3) Do not turn on ventilation fans or lights in a panic. (Sparks from the switch could ignite the gas and cause an explosion.)
- (4) Inform the surrounding community about the gas leak, evacuate the area, and report the leak to the emergency contact.

4 In case of a fire

(1) Discovery and reporting

If you start or discover a fire, notify people around you in a loud voice, ask for their cooperation, press the transmitter button, and activate the emergency bell.

(2) First response firefighting

Depending on the situation, use fire extinguishers or indoor fire hydrants to extinguish fires in the initial stages.

(3) Evacuation

The limit of first response firefighting is until the fire reaches the ceiling. If the fire is out of control, evacuate to a safe place. Close the doors and windows before leaving. Do not be concerned about your belongings. Do not use elevators.

5 In case of an earthquake

- (1) When there is an earthquake early warning or a tremor, first secure your safety by hiding under a table or other object. After the tremors subside, extinguish fires, etc.
- (2) Open doors and secure exits. Do not rush outside.
- (3) If a fire breaks out, attempt to extinguish it at the initial stage according to the situation.
- (4) Stay away from gates and walls. When indoors, watch out for shards of glass.
- (5) Cooperate with others to administer first aid.
- (6) Act based on accurate information provided by radio, TV, Internet, etc.

Appendix 1 Procedures for after-hours experiments, etc.

The following procedures must be taken when conducting experiments in each laboratory during the following hours.

1 Target time

Date	Time
Monday - Friday	9:00 p.m. – 8:30 a.m. of the next day
Saturday, Sunday, and Holidays	All day

2 If you wish to conduct an after-hours experiments

- (1) If two or more students wish to conduct an experiment during the above hours, they must fill the "時間外居残り届" form (Attachment 1) and obtain approval from their academic advisor. (If the faculty advisor is on campus and can be reached, the form is not required.) The "時間外居残り届" form is posted on the bulletin board on each floor (or in front of the laboratory on floors without bulletin boards). After the experiment is finished, it should be removed from the bulletin board and submitted to the Section of Administration Office(系事務室). (No after-hours experiment will be approved for only one student. However, if the supervising faculty member is in the same room, the experiment will be approved and no notification is required.)
- (2) Experiments that are expected to be dangerous will not be conducted. In principle, experiments will not be conducted on Saturdays, Sundays, national holidays, or other holidays. If an experiment must be conducted for unavoidable reasons, sufficient instructions must be obtained from the supervising professor in advance.

3 If you wish to conduct an all-night unattended operation

- 1) When conducting an unattended operation, complete the "終夜無人運転中" form (Attachment 2) and obtain instructions and approval from the supervising instructor. (Notification and approval are not required for freezers and air conditioners.) Unattended operation of potentially hazardous experimental equipment will not be conducted.
- 2) The "All-Night Unattended Operation" form (Attachment 2) should be posted at the entrance of the laboratory.

4 Other

- 1) Please note that a bulletin board is available on each floor of each building for posting a "時間外居残り届".
- 2) Anyone who finds anything unusual in a reported laboratory or a laboratory in unmanned operation throughout the night should contact the person listed in the "Contact" column and report it to the monitoring room (Energy Center Ext. 9290, direct line 0258-47-9290).
- 3) In addition to the above notification, depending on the situation, the person should also call the campus emergency response phone (extension 9999, direct dial 0258-47-9999), the fire department (119), etc.

別紙1

時間外居残り届	
日時	令和 年 月 日()時から 月 日()時まで
室名	実験室 系 号室(内線)
	居室 系 号室(内線)
区分	実験・デスクワーク・両方
実験内容	
居残者氏名	
異常時 教員連絡先	
指導教員 ・サイン	

別紙2

終夜無人運転中	
日時	令和 年 月 日()時から 月 日()時まで
室名	実験室 系 号室(内線)
実験内容	
予想される 危険な状況	
実験者氏名	
異常時 連絡先	学生 外線 ー
	教員 内線 外線 ー
指導教員 ・サイン	

Forms available at:

https://www.nagaokaut.ac.jp/gakunai/designated/jinji_romu/JIKO/jiko.files/todoke.xlsx

Appendix 2 Contact system for accidents involving students, etc.

Initial response flow chart when a student has an accident, etc.

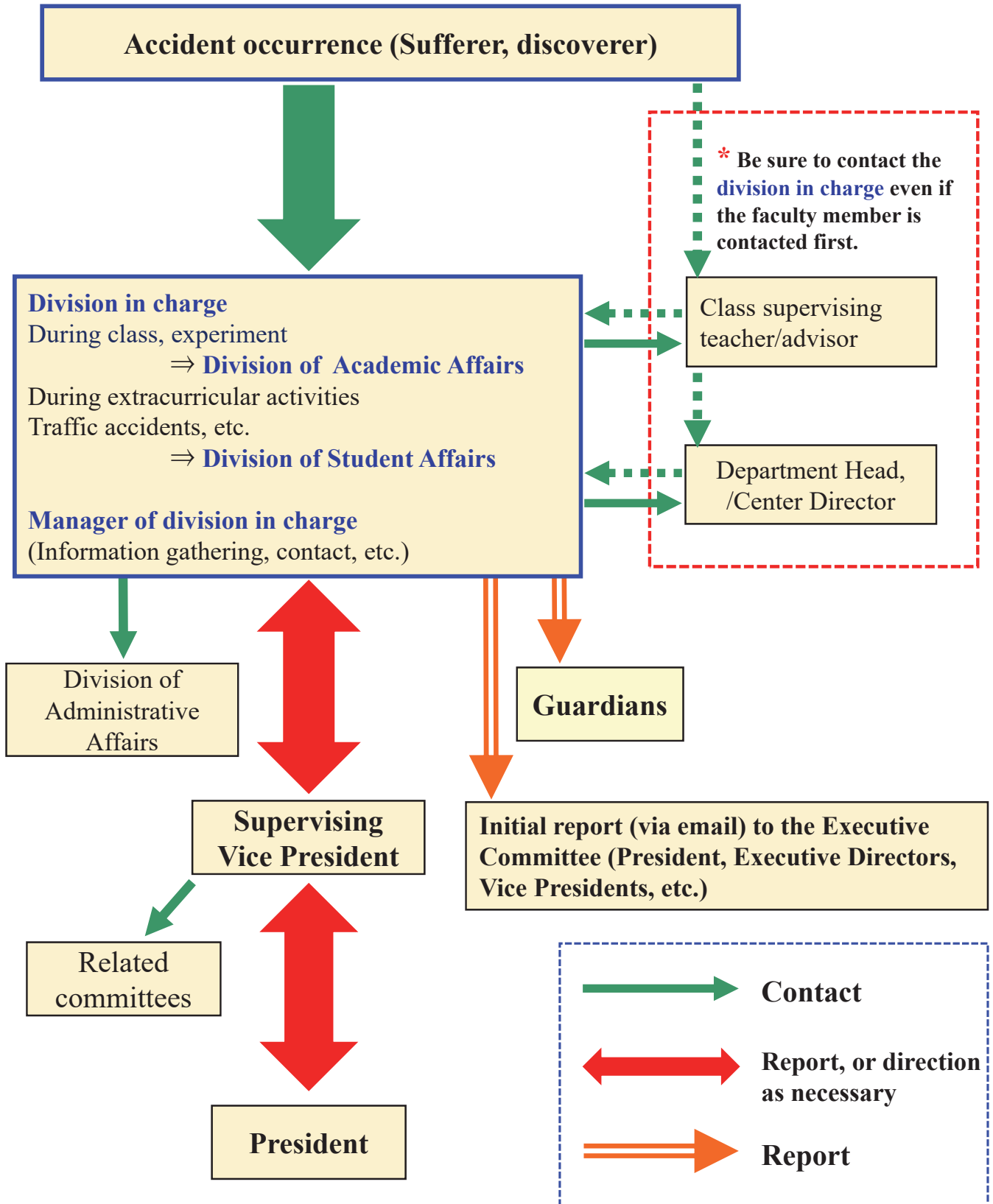

1 Roles of the HQ team

Team	Roles
Information and communication team	<ul style="list-style-type: none"> ◆ Assessing the status of self-defense firefighting activities and recording information ◆ Notification to the fire department and confirmation of the notification ◆ Emergency broadcasts and instructions to the school ◆ Establishment of Disaster Control Headquarters and Mobile Headquarters ◆ Assessing evacuation status ◆ Contacting relevant organizations and persons ◆ Confirmation of staff safety
Fire brigade	<ul style="list-style-type: none"> ◆ Proceeding directly to the floor where the fire broke out and engaging in first response firefighting using an indoor fire hydrant ◆ Cooperation and assistance with the fire brigade
Evacuation guidance team	<ul style="list-style-type: none"> ◆ Going directly to the floor where the fire broke out and to the upper floors, and giving the order to start evacuations ◆ Confirming that emergency exits are open and removing items that may obstruct evacuation ◆ Confirmation of persons unable to escape and those in need of rescue, and communication to headquarters
Operations team	<ul style="list-style-type: none"> ◆ Going directly to the fire area and closing fire doors, fireproof shutters, fireproof tamper, etc. ◆ Emergency measures for elevators ◆ Secure emergency power supply ◆ Prohibiting entry into hazardous areas
First aid team	<ul style="list-style-type: none"> ◆ Establishment of the first aid station ◆ First aid for the injured ◆ Cooperation with and provision of information to emergency services
Safety confirmation team	<ul style="list-style-type: none"> ◆ Confirmation of student safety ◆ Establishing evacuation shelters

2 District team roles

Team	Roles
Information and communication team	<ul style="list-style-type: none"> ◆ Identification of the disaster location and damage, collection of information, and reporting to the manager of self-defense fire brigade
Fire brigade	<ul style="list-style-type: none"> ◆ Initial fire extinguishing using fire extinguishers ◆ Guidance of headquarters fire brigade
Evacuation guidance team	<ul style="list-style-type: none"> ◆ Guidance of evacuees during fires ◆ Confirmation of evacuation status and reporting to the manager of self-defense fire brigade

District organization

District	Scope
1st District	Materials Science and Management Information Systems Buildings No. 1-3, General Research Building, Chemical Storage, Physical Chemistry Laboratory Building, RI Center, Analysis Development Center
2nd District	Electricity Buildings No. 1-3, Information System Building, Extreme Energy-Density Research Institute, Shared Laboratory Building
3rd District	Mechanical Construction 1-4, Bldg. for Doctoral Study 1, Nuclear System Safety Engineering and System Safety Building, Bldg. for Large Experimental Facilities, Sound and Vibration Engineering Center, Operations Center, Experimental Training 1-2
4th District	Biology 1 Building, Environmental Systems Building, Technology Development Center, High Pressure Experimental Facility

The above buildings include facilities attached to them.

To the extent other than the above, the headquarters unit shall also serve as the district unit.

Appendix 4 Safety and health management system chart

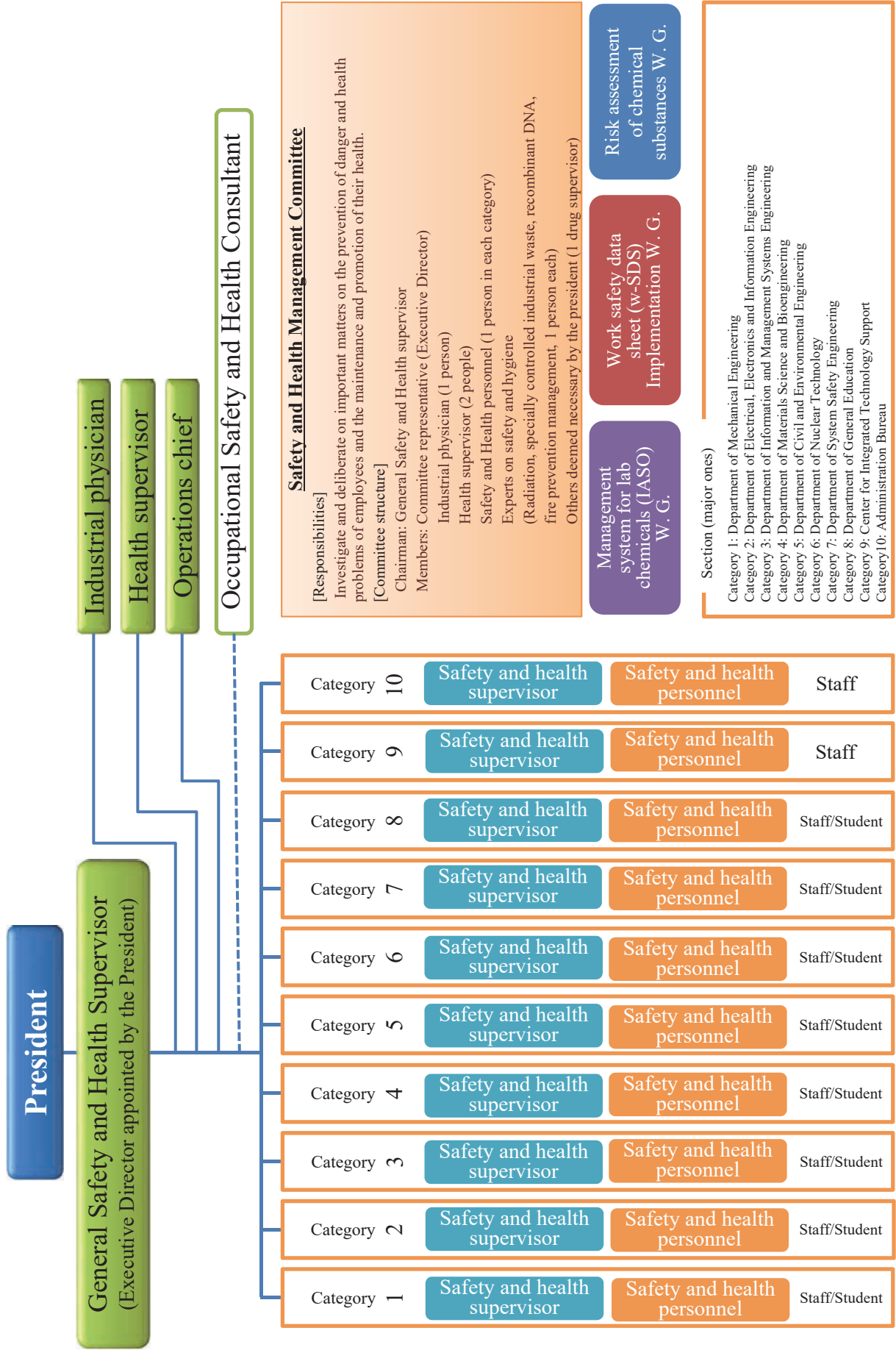

Even with adequate safety precautions, accidents can occur. In such cases, first aid is necessary. While first aid technically means the minimum necessary care, if appropriate measures are taken, a life can often be saved and the target's course after the accident can be improved. In this section, we will only briefly discuss the treatment of impaired consciousness (A, B, C, and D of resuscitation), hemostasis, fractures, etc. The first principle is to leave the matter to the experts as soon as possible. Emphasis should be placed on the importance of this. We would also like to emphasize the importance of maintaining a calm and collected state of mind.

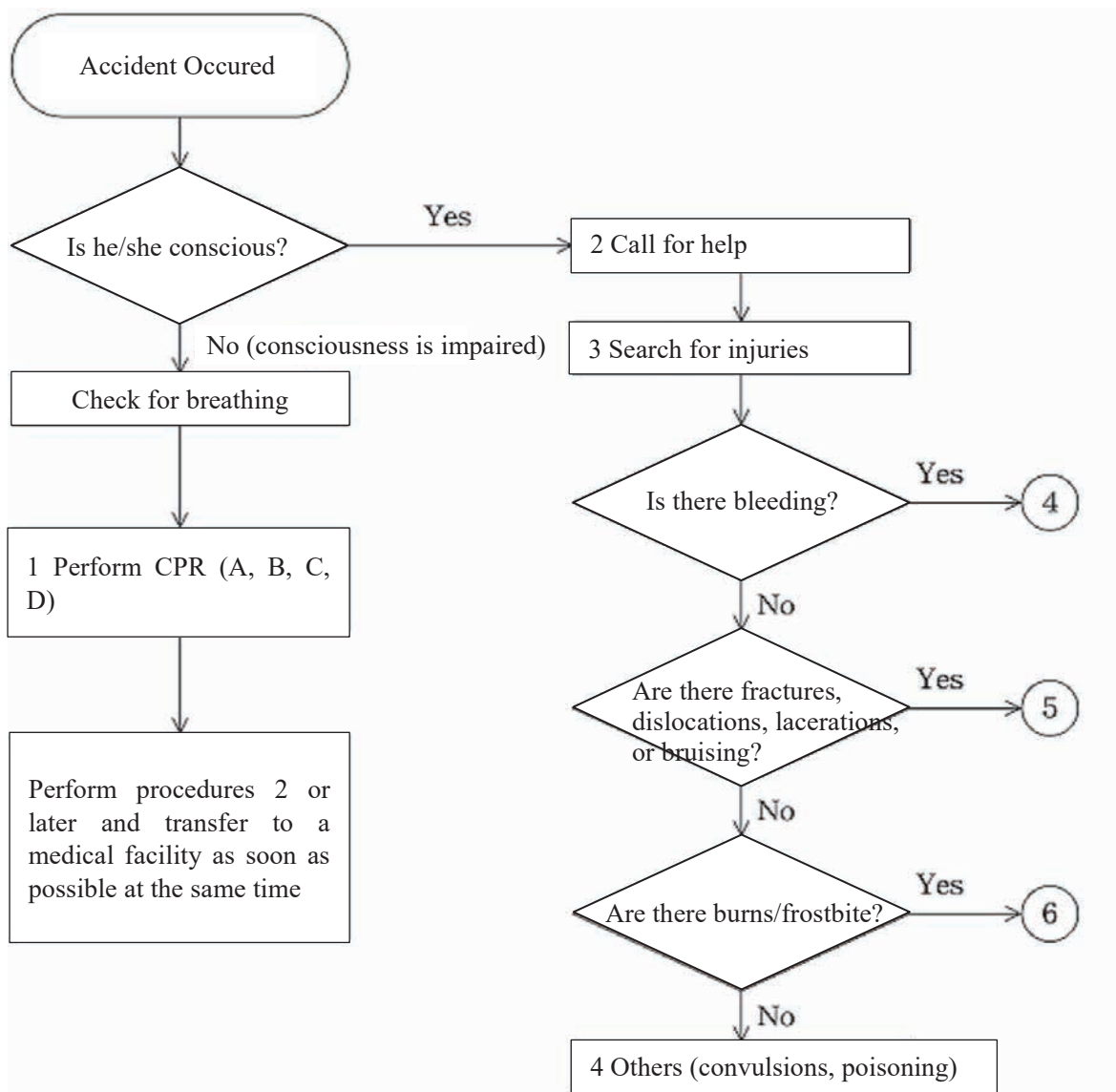

1 Impaired consciousness (A, B, C, D → CAB+D in emergency resuscitations)

The most important factor is whether the target is conscious. If consciousness is impaired, saving the target's life is a matter of seconds.

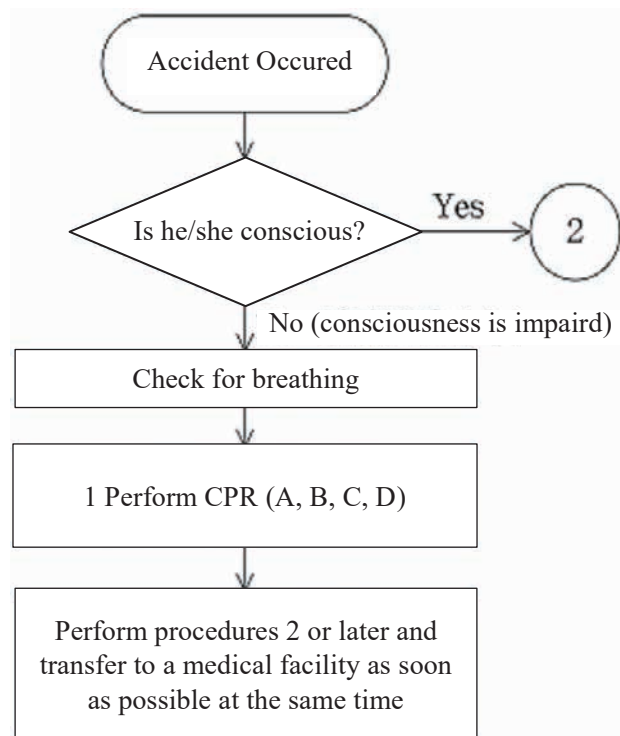

[Treatment method]

A Airway management (Airway)

If consciousness is impaired, the body loses its self-protective reflex against airway obstruction. Therefore, securing the airway (enabling breathing) should be the foremost priority. The target should be placed in a dorsal recumbent position, with the head flexed backward and the mandible pushed forward (Figure 2-1).

If there is fluid in the mouth, the target should be placed in the lateral recumbent position and the corners of the mouth should be pulled down to let the fluid flow out or be scraped out with the fingers.

B Artificial respiration (Breathing)

Check for breathing, and if the target is not breathing, administer artificial respiration (mouth-to-mouth artificial respiration). Pinch the target's nose, open the mouth wide, cover the target's mouth, and breathe into the patient's chest until you feel the chest rise (Figure 2-1).

Separate from the target's mouth, watch the chest deflate, and feel the airflow of the breath with your ears. Blow in two slow breaths for one second each.

C Cardiac massage (Circulation)

If there are no signs of circulation (breathing, coughing, body movements), cardiac arrest may have occurred. Therefore, chest compression cardiac massage should be performed immediately. If two persons are involved, one should perform cardiac massage and the other should perform artificial cardiac massage. Perform one artificial respiration for every fifth chest compression (Figure 2-1).

If performed by one person, perform 30 consecutive chest compressions at a rate of at least 100 compressions per minute, followed by two ventilations, and repeat. If the patient is lying on a soft bed or sofa, place a hard slab under the body or move the patient to a hard surface such as the floor where the chest compressions will not cause the body to sink. Continue until an ambulance or physician arrives.

D Defibrillation

Sudden cardiac deaths due to causes other than accidents have recently received increased attention. The majority of cases are due to ventricular fibrillation, a condition for which, in addition to the ABCs of emergency resuscitation, further defibrillation of the heart using an **automated external defibrillator (AED) is urgently required, and the emergency resuscitation ABCD (the latest is this Defibrillation as CAB+D) (the highest priority)**. One AED is located on campus in each of the following locations: Administration Bldg. 1, Lecture Bldg., Cafeteria, Physical Education and Health Care Center, Energy Center, Extreme Energy-Density Research Institute, Faculty Bldg. 1 (Mechanical Engineering and Civil Engineering), and Club House (refer to AED Locations on the next page.) In principle, AEDs are to be used by qualified personnel who have studied a course in their use, but in an emergency, they may be used by anyone.

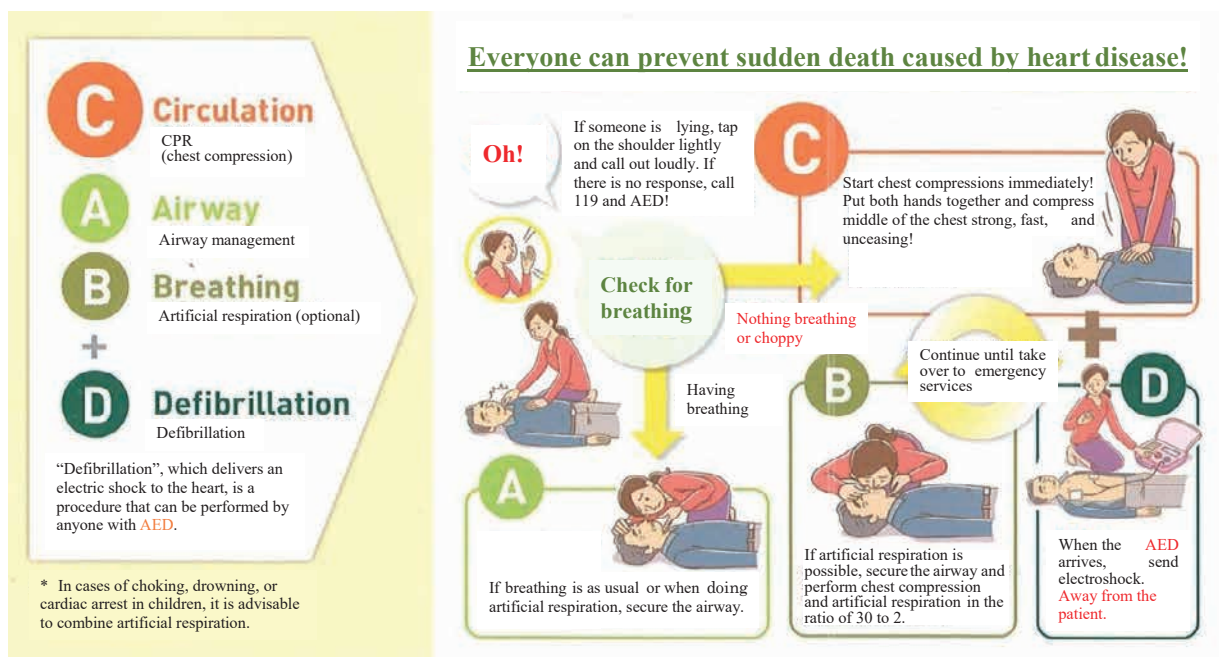
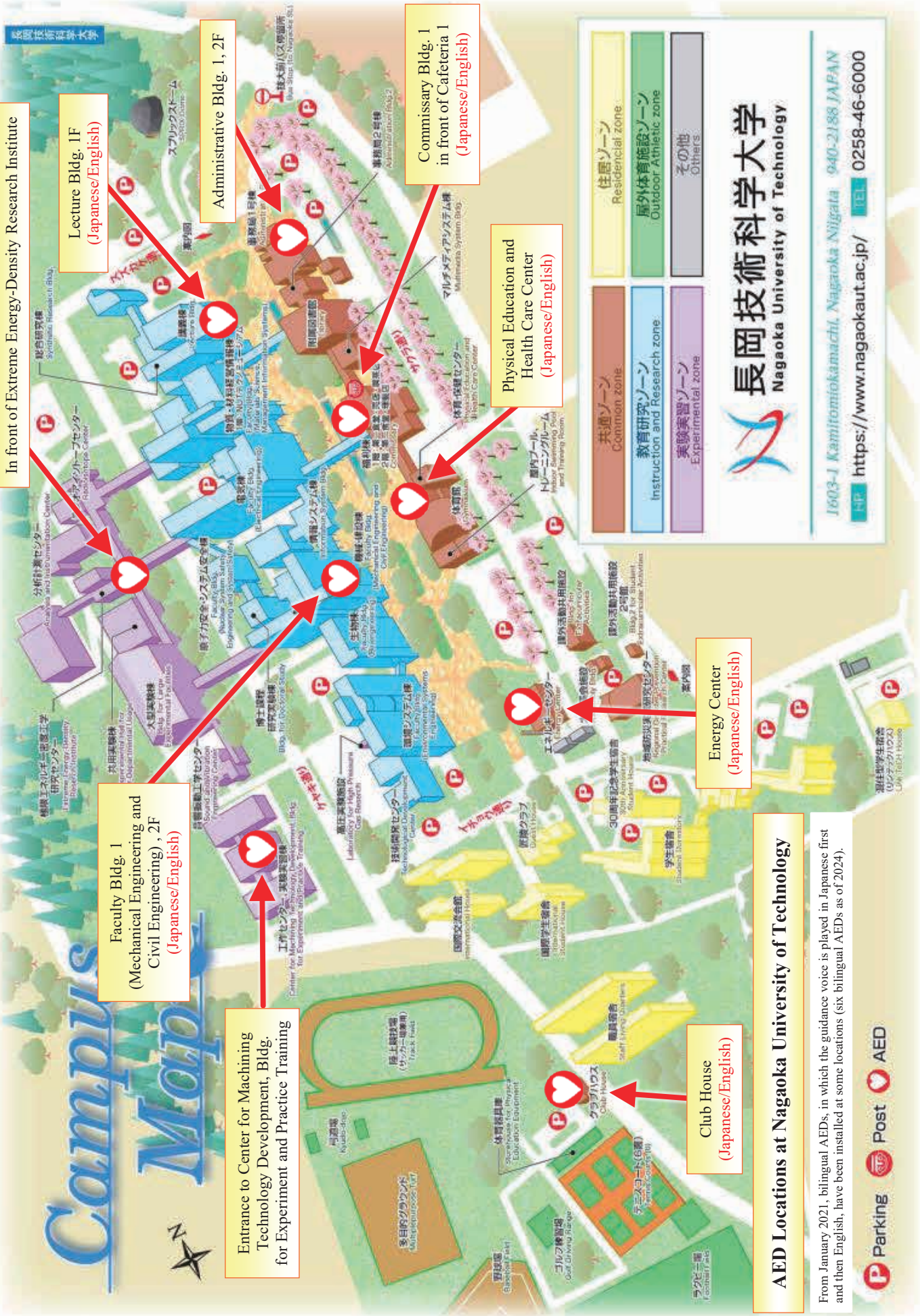

Figure 2-1 CAB+D of emergency resuscitation (from the Japan Medical Association)



In front of Extreme Energy-Density Research Institute

Lecture Bldg. 1F
(Japanese/English)

Administrative Bldg. 1, 2F

Commissary Bldg. 1
in front of Cafeteria 1
(Japanese/English)

Physical Education and
Health Care Center
(Japanese/English)

Faculty Bldg. 1
(Mechanical Engineering and
Civil Engineering), 2F
(Japanese/English)

Entrance to Center for Machining
Technology Development, Bldg.
for Experiment and Practice Training

Energy Center
(Japanese/English)

Club House
(Japanese/English)

共通ゾーン Common zone	住居ゾーン Residential zone
教育研究ゾーン Instruction and Research zone	屋外体育施設ゾーン Outdoor Athletic zone
実験実習ゾーン Experimental zone	その他 Others

長岡技術科学大学
Nagaoka University of Technology

1603-1 Kamifomikamachi, Nagaoka, Niigata 940-2188 JAPAN
HP <https://www.nagaokaut.ac.jp/> TEL 0258-46-6000

AED Locations at Nagaoka University of Technology

From January 2021, bilingual AEDs, in which the guidance voice is played in Japanese first and then English, have been installed at some locations (six bilingual AEDs as of 2024).



2 Call for help

Even relatively minor injuries may later exhibit severe complications (e.g., whiplash, hip dislocation in the passenger seat of a car, intracranial hemorrhage, internal injuries, etc.) and are often upsetting at the outset. First, call for help. Next, if there is a chance, turn off machinery and other equipment to prevent subsequent accidents. Hence, a person to perform first-aid is required. The rescuer must provide the necessary treatment and ensure that the patient is at rest (physically and mentally).

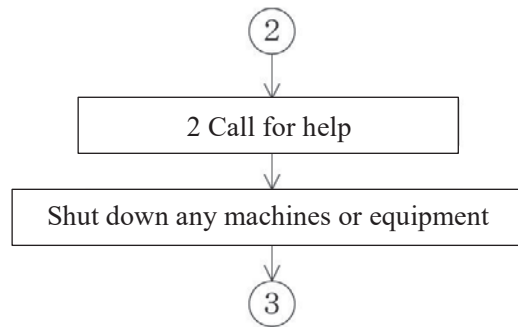

3 Check the injuries

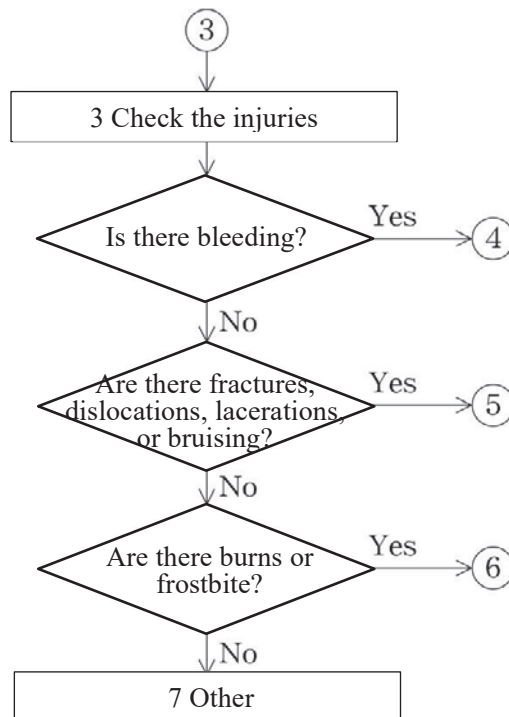

4 If the victim is bleeding

If bleeding is present, local pressure must be applied to stop the bleeding. A bleeding of approximately 1.5 L is life-threatening. However, deep, non-visible areas (bruises, fractures, etc., particularly in the head) are often unknown; thus, in such a possible case, the affected area should be cooled and the patient taken to a medical facility as soon as possible.

[Hemostatic measures]

(1) Direct pressure hemostasis

Press down hard with a cloth, handkerchief, towel, etc. and keep in place for at least 10 min. Do not remove pressure unnecessarily. If sufficient pressure is applied, most cases will stop bleeding. At the very least, this will reduce the amount of bleeding.

(2) Indirect pressure hemostasis

If the bleeding point is farther from the heart than the tourniquet in Figure 2-2, apply tourniquet pressure to that point. It must be loosened at least once every 30 min, and this method requires skill. Therefore, it is essential that the patient be transported to a medical facility as soon as possible after the tourniquet is applied. When the tourniquet is applied, the wound should be disinfected as soon as possible.

☆Dismemberment

If a finger or other part is amputated, the amputated piece may be reattached by surgery if it is managed as cleanly as possible, placed in a plastic bag, etc., and cooled with ice.

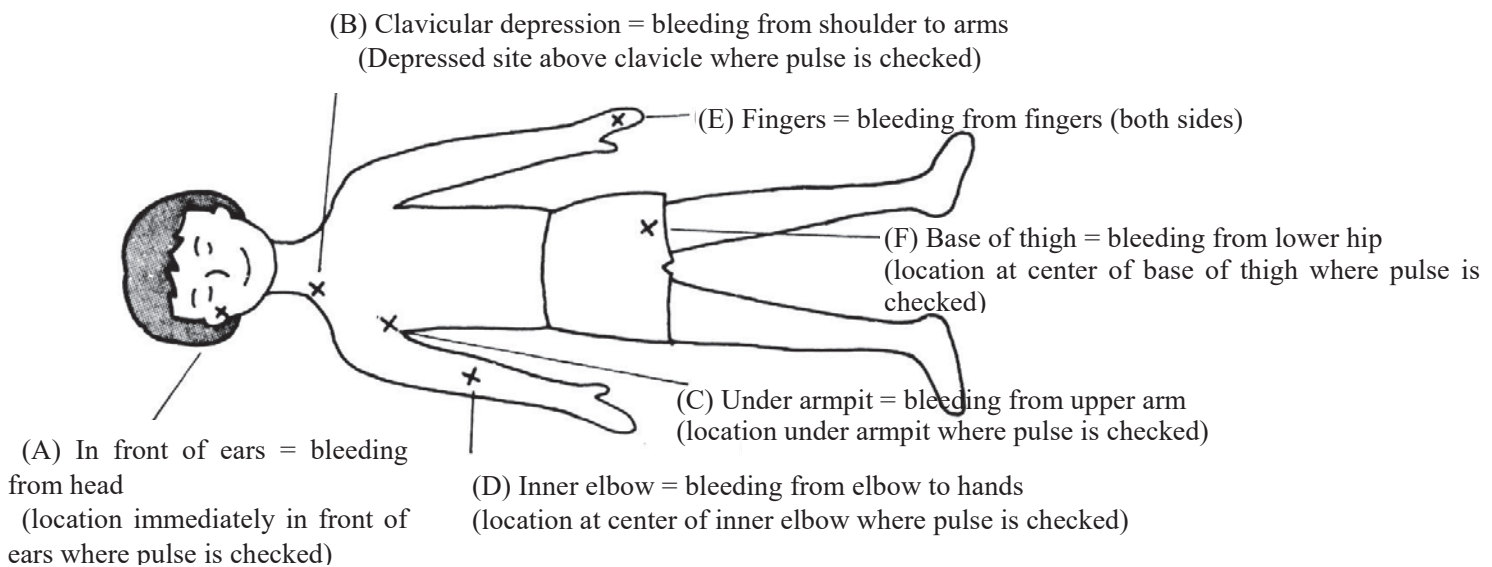
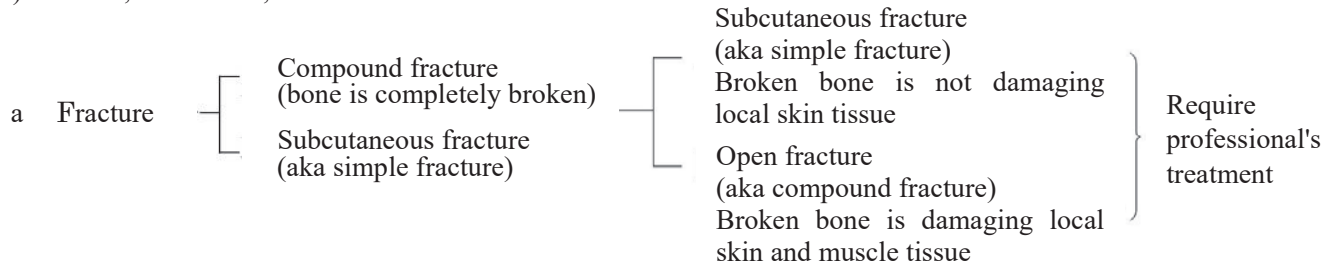

Figure 2-2 main hemostatic points

5 Fractures, dislocations, lacerations, and bruising

(1) Fracture, dislocation, and laceration



b Dislocation - a joint dislocated due to a strong external impact

c Laceration - a sprain in which the muscles (ligaments) or blood vessels that connect the joint are damaged after the joint has been dislocated and returned to its original position

[Treatment]

⊙ Fractures

- Excruciating pain when moved or touched.
- Swollen.
- Deformed.
- Unable to move.
- Bleeding from the wound and bone protruding. (Open fracture)

1) The victim should be moved as minimally as possible and treated on the spot.

2) Generally, the victim should be placed horizontally on his/her back, but if the shoulder, collarbone, or arm is injured, it is easier to place the patient in a sitting position.

3) For hands (fingers, wrists, forearms, upper arms) and feet (ankles, lower legs), the patient should be immobilized with a splint and transported to the hospital but should be kept warm and handled with care as bleeding and pain often cause shock symptoms.

4) Materials for creating a splint include splint wood, umbrella, newspaper or magazine rolled into a stick shape, cardboard cut into long, thin strips, disposable chopsticks, object pointers, blankets, bedding, etc.

⊙ Dislocation (Treat as for a fracture.)

- Joint is deformed.
- Swollen and painful.
- Inability to move.
- Dislocation of the shoulder, jaw, elbow, or fingers is common but can be fatal if it occurs in the spine or cervical vertebrae; therefore, the victim must be handled carefully.

If not healed properly, the joint may become immobile; therefore, be sure to consult an orthopedic surgeon.

- 1) Cool the dislocated area. (Place an ice-cube or cooled towel in a plastic bag.)
- 2) Fix the dislocated joint with a triangular bandage or bandage to prevent it from moving.

◎ Lacerations

- Joints swell.
- Internal bleeding changes the color of the skin.
- Painful when touched.
- Ankles, wrists, fingers, and knees are most likely to be affected.

- 1) After applying a sponge, cotton, or other material and fixing it with a bandage, soak it in cold water for about 30 minutes to cool it down.
- 2) Remove the wet bandage, apply a poultice (Zenol, Patex, etc.), wrap the bandage slightly tighter, and elevate it on a cushion or something similar to keep it at rest. (If no poultice is available, apply an ice pack over the bandage and keep the patient cool for about one day.
- 3) Have the victim rest until the swelling eases.
- 4) Do not rub the affected area.
- 5) Do not bathe while the victim is in pain.
- 6) If the pain is severe, consult an orthopedic surgeon.

(2) Bruising

Even in the absence of bleeding, there may be subcutaneous hemorrhage, internal bleeding, or internal organ damage, which requires close observation. Observation for more than one day is necessary, particularly in cases involving the head. If pain or subcutaneous bleeding is present and a fracture or internal organ injury is suspected, the victim must be immediately transported to a medical institution. However, extreme caution should be exercised as the condition may be aggravated by transport.

[Treatment]

- 1) Cooling. Cooling is useful regardless of the presence or absence of pain or subcutaneous bleeding.
- 2) Rest.

6 Burns, frostbite, etc.

(1) Burns

If the wound site is small, cool it anyway. Any method that removes heat from the affected area is acceptable. Cold water, ice cubes, pieces of metal. Keep the site cool until the pain subsides.

The severity of the burn is related to the area of the burn, which can be dangerous if it exceeds 15% of the body's surface area. Cool thoroughly, cover with a clean cloth or towel, and promptly seek medical attention.

(2) Frostbite

The opposite of burns, local heating is performed by immersing the affected area in warm water (the temperature of bath water) at 38–42 °C for a while. However, as with burns, it is essential to take the patient to a medical institution as soon as possible.

(3) Explosions

Often accompanied by burns. However, be particularly careful as the airway may be affected. In addition, the eyes and respiratory system may be affected by the compounds produced. Be careful of eye trauma and ruptured eardrums.

(4) Electric shock (electrocution)

Generally, mortality is high. A cardiac massage is necessary, particularly since it is often due to cardiac arrest. If respiratory arrest occurs, artificial respiration is necessary. See CAB+D in Emergency Resuscitation.

(5) Heat stroke

This is most likely to occur when working in a hot environment for a long period of time. There are two types of heat stroke, hyperthermia and simple dehydration, the former being life-threatening. In either case, the patient must be cooled down and taken to a medical institution as soon as possible.

(6) Hypothermia

Remove wet clothing and warm with warm water. Oxygen is required.

7 Convulsions, poisoning

(1) Seizures

If unconscious, perform CAB+D for emergency resuscitation; loosen clothing and keep hazardous materials away from the area. Lay the victim on his/her side or face to the side.

(2) Poisoning

Even if the causative agent is unclear, in severely poisoned patients, it is imperative to first normalize breathing and circulation to sustain life, while eliminating toxic substances and preventing breathing.

1) Isolation from the incident site

In gas poisoning, the patient should be evacuated from the scene as quickly as possible and administered fresh air to breathe. (Oxygen inhalation is even better if possible.)

2) Cleaning of body surfaces

Toxic substances adhering to the body surface should be washed out thoroughly with water for the time being.

3) Emesis (induction of vomiting)

If it is certain that the patient has orally ingested the poison and has not yet vomited, induce

vomiting to eliminate the poison. However, vomiting should not be induced when the patient is unconscious, or when corrosive poisons (acids, alkalis, etc.) or volatile poisons (kerosene, gasoline, etc.) have been ingested. Mechanical stimulation of the pharynx with a finger or other object should be used to induce vomiting.

Take the above first aid measures and get medical attention immediately.

<Important> Always have an **SDS on hand**.

The “Act Concerning Reporting, etc. of Releases to the Environment of Specific Chemical Substances and Promoting Improvements in Their Management” (Chemical Substances Control Act), promulgated on July 13, 1999, obliges manufacturers to issue a **Safety Data Sheet for Chemical Substances (SDS)**. SDSs can be obtained for most of the chemicals in the laboratory from the purchasing vendor. These SDSs contain information on first aid measures (measures to be taken in the event of harm to employees or others caused by the substance, specifically if the substance is “inhaled,” “adheres to skin,” “gets in eyes,” or “swallowed”). SDSs can be obtained from the University’s Drug Management Support System or on the Internet. For details, please refer to the following URLs.

8 Reference URLs

- Cardiopulmonary resuscitation procedure

<https://www.med.or.jp/99/cpr.html>

- AED

<http://www.mhlw.go.jp/shingi/2004/07/s0701-3.html>

<http://www.aed-life.com/>

- SDS

Japan Reagent Association (M)SDS Search

<http://www.j-shiyaku.or.jp/Sds>

- Act Concerning Reporting, etc. of Releases to the Environment of Specific Chemical Substances and Promoting Improvements in Their Management (PRTR System and SDS System)

Ministry of Economy, Trade and Industry

http://www.meti.go.jp/policy/chemical_management/law/index.html

Ministry of Health, Labour and Welfare

<http://www.mhlw.go.jp/new-info/kobetu/seikatu/kagaku/index.html>

Act Concerning Control of Poisonous and Deleterious Substances (Poisonous and Deleterious Substances Control Act)

<http://www.nihs.go.jp/law/dokugeki/dokugeki.html>

Ministry of the Environment

<http://www.env.go.jp/chemi/prtr/risk0.html>

○Globally Harmonized System of Classification and Labeling of Chemicals (GHS)

<http://www.env.go.jp/chemi/ghs/>

○Tokyo Institute of Technology Integrated Safety Management Center

<http://www.gsmc.titech.ac.jp/>

Section 1 Introduction

"People make mistakes. We need to assume they will make mistakes and respond accordingly."

1 Beginner's Guide

New and transfer students should follow the teachings of faculty members and senior students and become accustomed to life at the University as quickly as possible.

- (1) Familiarize yourself with the performance of equipment, tools, and instruments, and learn how to operate them and use them with care.
- (2) Ask a faculty member or senior staff member if anything is suspicious or unclear, even if it is a small matter. Be careful not to make hasty judgments or assumptions on your own, as this can result in injury.
- (3) As you become accustomed to the work, you will tend to relax. Be mindful not to become distracted or negligent when conducting experiments.

2 Clothing and footwear

The priority in appropriate clothing for work is to make it easy to work and to protect oneself from disasters. There have been many cases of severe injury due to forgetting this point; therefore, the following precautions should be considered.

- (1) When conducting experiments using chemicals, wear long-sleeved jackets and other clothing that does not expose the extremities. Wear a white lab coat and properly use protective equipment such as safety glasses.
- (2) Shirt hems that may get caught in rotating machinery should be tucked into pants.
- (3) In general, non-slip footwear should be used, and never wear shoes with untied laces or step on the heels of the shoes, as there is a risk of tripping.

3 Posture

- (1) It is important to work in a stable posture suited to the task, with a relaxed and straight back.
- (2) Face the desk straight, sit deeply in the chair, and try to work in a natural posture.
- (3) Continuing in the same posture for extended periods causes "static fatigue" due to the continuous tension and contraction of certain muscle groups. It is necessary to eliminate this "static fatigue" through light exercise, etc.

4 Organization, neatness, cleaning, and sanitation

The fundamentals of safety are organization, neatness, cleaning, and sanitation. In many cases, poor organization and tidiness are the causes of disasters.

(1) Desk organization

- (a) The desktop should be kept clean at all times for it to be used spaciouly, and office supplies should be organized.
- (b) When leaving your seat, be sure to retract your chair under the desk/table.

(2) Object placement

- (a) All items should be placed in a designated area and always in place.
- (b) Items should be aligned at one end or one side, particularly against an aisle, with the aisle face aligned.
- (c) Do not place objects that obstruct lighting on the window side.
- (d) Tall shelves, bookcases, glass shelves, etc. should always be placed near the wall to prevent them from tipping over, and earthquake-proof measures should be implemented.
- (e) Documents and items should not protrude from shelves and desks.

(3) Organization of aisles

- (a) Do not place any objects in the aisles.
- (b) Do not place any objects near aisle entrances, emergency exits, stairways, etc., indoor fire hydrants, or fire extinguishers.
- (c) Do not place fragile, flammable, or dangerous objects near aisles.

(4) Cleaning

- (a) Make an effort to be organized, neat, and clean every day.
- (b) Sink areas should be cleaned regularly, paying particular attention to sanitation.

Section 2 Examples of minor accidents and lessons learned

Often minor accidents occur in the laboratory. Fire, water, electricity, heavy objects, and chemicals are the main causes of accidents. Some examples are given below.

1 Examples of accidents resulting in death or injury

In October 1991, during an experiment using Chemical Vapor Deposition (CVD) equipment at a university in Osaka, an explosion occurred in a cylinder supplying monosilane. The check valve on the nitrous oxide purge line did not operate properly owing to a deterioration of the O-ring, causing nitrous oxide to flow back into the monosilane cylinder through the purge line, forming an explosive gas mixture that exploded from an ignition source. This incident triggered a revision of the High-Pressure Gas Control Act.

2 Examples of nearly fire incident

- (1) A gas stove was being used in the laboratory and a beaker was being filled with alcohol and machine parts were being cleaned near the stove. The beaker was inadvertently dropped on the floor, and although the spilled alcohol ignited the stove and caught fire, the fire did not cause severe damage because there were no combustible materials nearby.
- (2) In an experiment to concentrate a sample solution using a rotary evaporator, a plastic basin was used as a water tank, and the water was heated using a throw-in heater. After the experiment was over, the sample solution was heated using a throw-in heater. Several hours later, the water in the basin evaporated, the basin became empty, and the plastic basin burned owing to the heating of the heater. This triggered the smoke detector in the room and set off the fire alarm; the staff rushed to the room and extinguished the fire using a fire extinguisher, and the fire was extinguished, and only the wash basin and the rubber pipe for cooling water were destroyed by fire.
- (3) When making sample pieces from magnesium-lithium ingots, the ingots were hand-sawed and sanded. After the work, the chips and fine powder from the filing were placed in an iron can and left without closing the lid of the can. The humidity in the air oxidized the fine powder, and the heat stored from the oxidation caused the powder to spontaneously combust, scorching part of the floor surface.
- (4) When using a dryer or experimental apparatus, the state of progress was not checked. In addition, the sample in the apparatus overheated and became a blur because the operator left the apparatus.

These examples show that accidents are not caused by a single cause but are the result of a cascade of unfortunate incidents caused by several inadvertent events. Additionally, if a lucky break occurs along the way, a major accident may be prevented. Therefore, safety measures should be performed in duplicate or triplicate.

Fire is the most dreaded accident for researchers. A fire may take the lives and time of not only you, but also those around you. Furthermore, it not only ruins the experimental equipment but also causes the loss of various data that have been accumulated up to that point. It takes a significant amount of time to obtain data. Money can buy experimental equipment, but it cannot buy human life or time. Preventive measures are simple: do not use flammable liquids or gases in a place where there is fire, do not place flammable materials, and do not leave the vicinity of experimental equipment.

3 Water accidents

- (1) An oil diffusion pump used to exhaust the vacuum system was water-cooled; thus, tap water was run from the faucet through a vinyl hose. However, the vinyl hose had become old and had a small hole in it. Vinyl tape was wrapped around it to temporarily plug the hole. Although the researcher considered replacing it with a new one later, since there was no water leakage, it was left unchanged and the

researcher went home. That night, the pressure of the water supply increased, and water leaked from the emergency hole, flooding not only the laboratory but also the laboratory on the floor below.

- (2) A researcher opened a water tap to conduct an experiment, but the water was cut off due to construction that day, so the researcher went home without closing the tap. When the water was restored, the cooling hose connected to the experimental apparatus was disconnected due to the water pressure during the restoration, and the room was flooded.

These accident examples teach us that makeshift procedures should not be used. It should be noted that makeshift measures become permanent, and ultimately result in accidents. It should also be noted that the connection points of hoses used for faucets and laboratory equipment are the places where the most trouble can occur. Many electronic devices and instruments become unusable when exposed to water, and accidents can also occur as a result of a remote cause of water exposure. In addition, reports and books are ruined when wet, which can hinder research.

4 Faulty electrical wiring

When wiring electrical equipment for experiments, makeshift wiring can result in accidents. For example, if two cords are not sufficiently long and are connected by simply twisting them together, after a long time, they may fail to make contact or generate heat, causing an accident. Frequently, when experimental equipment is repaired or modified, the wiring is implemented temporarily and left as it is, but after an extended period, it can cause accidents. Temporary easily turns into permanent.

5 Chemicals accidents

While a researcher prepared an aqueous solution of caustic soda on a laboratory table, the caustic soda solution suddenly boiled and splashed into the researcher's eye. The researcher immediately rinsed his eyes with plenty of water and rushed to an ophthalmologist, but he almost lost his eyesight. This accident occurred to a physics student who did not know how to handle chemicals. This shows that even physics students should have a rudimentary knowledge on handling chemicals and wear safety glasses. Conversely, students of chemistry and biology should also have a rudimentary knowledge on handling machinery and equipment.

6 Heavy objects

When lifting heavy objects, do not lift from the side or at an angle. Instead, face forward, hang your hands as deeply as possible, bend your knees, keep your hips low, and lift slowly to keep your spine vertical. Be careful not to lift too abruptly, as this may cause back pain.

When carrying objects by hand, do not carry items that obstruct your view. When carrying long or bulky items, make sure that there are no hazardous areas or obstacles on the course to prevent collisions.

Section 3 Measures to prevent major accidents

Most laboratory accidents can be prevented if common-sense precautions are taken. However, in the unlikely event of an accident, measures must be taken to prevent severe consequences. For example:

(1) Do not experiment alone at night. It is dangerous because no one is available to administer first aid or report an emergency if you are injured, lose consciousness, or otherwise become immobile.

If students wish to conduct experiments at night or on holidays, they must fill out an "In-Person Use" form and obtain approval from their supervisor. In addition, when conducting all-night unattended operations, etc., students must fill out the "All-night Unattended Use" form and obtain instructions and approval from their supervisor. This procedure is shown in Appendix 1.

(2) In summer, do not conduct experiments in short sleeves or other clothing that exposes skin. Contact with electricity to the naked body can cause limbs to move unintentionally, causing secondary accidents by touching nearby machines, instruments, or chemicals.

Major accidents rarely occur suddenly, and in most cases, some signs are evident (e.g., malfunction of machinery or equipment, physical condition, mood, etc.). If appropriate measures are taken at the first sign of irregularity, accidents can be prevented. Of course, major accidents must be reported as described in this guide, but the experimenter should also inform the person in charge of the laboratory of even minor problems in the laboratory. The person in charge must then take appropriate measures and nip major accidents in the bud before they occur. The importance of early detection and treatment does not only apply to the body.

Researchers are professionals and students learn from them. Although experiments and research are always risky, professionals know the boundary between safety and danger and work within the limits of safety. However, working outside safe limits, or working beyond the realm of safety realm is amateurish and is unbecoming of a real researcher or engineer.

Section 1 Electrical Safety Tips

1 What are the types of electrical accidents?

(1) Fire accidents

This is caused by leakage or poor contact due to faulty electrical work, short circuits due to aging of unmaintained equipment, improper use of equipment, overloaded operation, and tracking due to dust in electrical outlets.

(2) Electric shock accidents

This can be caused by inadequate electrical work or grounding, use of inappropriate equipment, careless operation with wet hands, etc., and can result in loss of life in an instant.

(3) Explosion accidents

Capacitors can explode if operated over capacity or a reverse voltage is applied to deteriorated capacitors or electrolytic capacitors. Moreover, when an oil-filled transformer is short-circuited, an explosion may also occur, requiring caution.

From the perspective of safety and management, various regulations have been established for various electrical facilities in terms of construction, management, and operation.

2 Fires caused by electricity

If the thickness of a copper wire (cable) is small, fire may occur due to overheating. Table 4-1 shows the allowable current values for insulated wires. Table 4-2 shows specific examples of causes of fire accidents and preventive measures.

Particular attention should be given to the following.

(1) Iron or copper wire should never be used as a substitute for fuses, nor should large-capacity fuses that exceed the capacity of the circuit be installed. Even if you want to use the equipment immediately, such as in the middle of an experiment, always prepare and use a spare fuse to avoid using a substitute or wire for convenience after removing the cause of the blown fuse. In addition, the use of circuit breakers eliminates the need for fuse maintenance.

(2) When using "octopus wiring," as it is commonly referred to (using several fixtures with branch sockets), carefully consider the electrical capacity used.

Since the danger of "octopus wiring" largely depends on the electrical capacity used, the number of plugs plugged into a table tap should, in principle, be less than or equal to the number of plugs, and the number of plugs should not be increased by connecting another table tap (the total capacity should

be less than or equal to the capacity of the table tap to be used.)

Large capacity appliances (such as electric heaters) should be connected directly to wall or floor outlets. Daily inspections are also necessary, such as taking care to avoid dusty outlets.

- (3) Do not use wiring or equipment that violates the law. Do not perform so-called amateur work.
- (4) Failure countermeasures and repairs of electrical machinery and equipment must be performed by engineers with expertise or in specialized factories, and must not be used as temporary first aid measures.
- (5) Do not neglect the care of electrical equipment. Always maintain them and keep them clean.
- (6) When wiring, etc., the experimental panel, or the breaker is turned off, clearly indicate this to prevent electric shock and lock the door to prevent others from accidentally energizing the equipment.
- (7) When using a drum cord, observe the allowable current for the drum cord and avoid using the cord while it is wound around the drum. There have been cases of cords not dissipating heat properly, resulting in fires even at our university. (Even a drum cord with a rated current of 15 A has an allowable current of approximately 5 A when left wound.)
- (8) The outlet is designed to clamp the plug terminal by the force of the metal spring, but if force is applied while the plug is plugged in, or if the plug is repeatedly and roughly plugged in or unplugged, or if it is bent in an inappropriate manner, there is a possibility that the contact will fail. When an arc occurs, the metal melts, and the area around the outlet becomes blackened and carbonized, making it more and more susceptible to arcing and leakage of electricity, with a very large possibility of fire as a result. When using large currents (15 A or more) in particular, wiring should be performed from the test board as much as possible. If power supply from an outlet is unavoidable, it is necessary to pay attention to the deterioration of the outlet, poor contact, and surrounding conditions, and replace it with a new one as soon as possible to prevent fire. In addition, when obtaining power from a test panel, use a breaker and wiring appropriate for the load capacity; otherwise, a fire may result.
- (9) In the event of a fire, immediately shut off the power supply and extinguish the fire using a fire extinguisher (powder fire extinguisher, etc.) suitable for electrical fires.

Table 4-1 Allowable current of insulated wires

Condition Conductor: Copper

Insulator: Vinyl or natural rubber with an allowable temperature of 60 °C

Ambient temperature: 30 °C

Wiring method: Overshot wiring and wiring with wires enclosed in the following

Metal pipes, metal wire spines, flexible conduit pipes, synthetic resin pipes, synthetic resin wire spines

Conductor		Insulator distribution line	VV cable (F cable) 3 leads or less	Wiring to pipe or wire pins			
				Number of wires in the same pipe or wire [wires]			
				>3	4	5-6	7-15
Type	Thickness*	Allowable current ratio					
		1.00	0.70	0.70	0.63	0.56	0.49
		Allowable current [A]					
Single wire	1 mm	(16)	—	(11)	(10)	(9)	(8)
	1.2	(19)	(13)	(13)	(12)	(10)	(9)
	1.6	27	19	19	17	15	13
	2	35	24	24	22	19	17
	2.6	48	33	33	30	27	23
	3.2	62	43	43	39	34	30
	4	81	—	56	51	45	39
	5	107	—	75	67	60	52
Formed single and stranded wires	0.9 mm ²	(17)	—	(12)	(10)	(9)	(8)
	1.25	(19)	—	(13)	(12)	(10)	(9)
	2	27	19	19	17	15	13
	3.5	37	24	26	23	20	18
	5.5	49	34	34	31	27	24
	8	61	42	42	38	34	30
	14	88	61	61	55	49	43
	22	115	80	80	72	64	56
	38	162	113	113	102	90	79
	60	217	150	152	137	121	106
	100	298	202	208	187	167	146
	150	395	269	276	248	221	193
	200	469	318	328	295	263	230
	250	556	367	389	350	310	272
	325	650	435	455	410	363	318
400	745	—	521	470	417	365	
500	842	—	590	530	471	413	

*For intermediate thicknesses, use the allowable current of the smaller size.

*Wires with a diameter of 1.2 mm or less and a cross-sectional area of 1.25 mm² or less are not generally recognized as wires for wiring; thus, the allowable current is shown in parentheses for reference.

(Reference) Allowable current in cord

Thin vinyl cords (cross-sectional area 0.75 mm²) 7 A

Thick vinyl cords (cross-sectional area 1.25 mm²) 12 A

Extra-thick vinyl cord (cross-sectional area 2.00 mm²) 17 A (e.g., OA tap rated 15 A)

Table 4-2 Causes of electrical fires and preventive measures

Cause		Preventative measures
Category	Specific examples	
Poor insulation of wiring	Carelessness when embedding or stippling cables into molding material	Periodically measure insulation resistance between wires and between wires and earth.
Incomplete connections	Poorly tightened wire connections or terminals on switches and fixtures	Inspect frequently and maintain in perfect condition.
Defective equipment	Poor insulation, short circuits, and leakage	Insulation resistance measurements and circuit tests should be performed, and defective parts should be completely repaired.
	Use of inferior electrical goods without type approval	Replace with suitable quality.
	Wear and tear	Renew at the end of its service life.
	Poorly cared for (dust and debris can interfere with heat dissipation and dust can burn). Dust accumulated between the electrodes of a plug that has been plugged into a wall outlet for a long period can become conductive owing to moisture in the air, resulting in a short circuit (tracking phenomenon).	Maintain in a state of complete maintenance by constant inspection and care.
	Faulty protective device (thermostat failure, no thermal fuse)	Repair protective devices.
Misuse of equipment	Overload during operation	Use within the rated load.
	Current over the allowable current is applied.	Use within the allowable current.
	Use other than the intended purpose (use a light bulb or a stove for a floor hearth.)	Use correctly.
Unsuitable for use	Short circuit	Check the circuit before connecting the power supply.
	Unsuitable operating environment (e.g., proximity to combustible materials)	Use according to the environment.
	Leaving the power on	Precautions during and after use
	Careless tipping over	Precautions during use

3 Electric shock accidents

The effect on the body is related to the magnitude and duration of the current passing through the heart, and even a considerably large current between the fingers will not cause death. The effects of electric shocks on the body are not generally clear-cut because of individual differences and differences in the parts of the body that are electrocuted, but are approximately as shown in Table 4-3.

However, even low voltages are dangerous when (1) sweating, (2) bare feet on concrete or on the ground,

(3) hands and feet are wet, or (4) while bathing. In addition, accidents can be further aggravated by electric shock causing falls and crashes, etc. Therefore, protective equipment such as helmets and safety belts should always be used when handling electrical equipment at high places.

Table 4-3 Effects on the body depending on the current value

Current value (mA)	Impact
1 (or less)	Feeling of electric shock and numbness.
5 or more	Feeling of pain and lingering sluggishness.
10	Feeling unbearable pain and trauma at the point of inflow of electric current.
20	Muscle contraction and spasms occur, and the body loses its freedom, and the electrocuted person himself cannot escape from the charging object.
30	Burn-like symptoms may occur, and the person may lose consciousness.
50	Breathing may cease, and in some cases, cardiac function may stop.
100	Fatal consequences and death in most cases.

4 How to prevent electric shock

- (1) Be careful not to touch the part directly connected to electricity (charging section). To check whether the power is being supplied, use an electric detector (do not use one built into the handle of a screwdriver) or a tester.

Lamp cover (Transparent smoke)

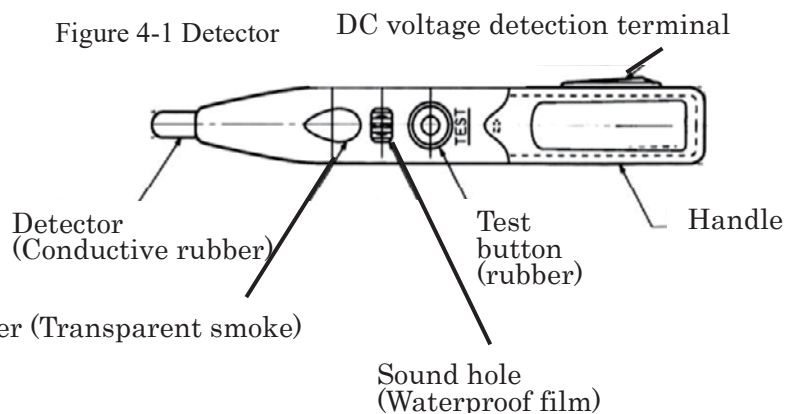

Figure 4-1 shows an electric detector. However, note that it is dangerous to use such a device to check equipment with a voltage exceeding 400 V.

- (2) Electrical equipment that requires the connection of a grounding (earth) wire should be grounded (earthed), and a 30 mA or less earth leakage circuit breaker should be used for power supplies that may cause electric shock.
- (3) High voltage is dangerous even if it is not touched; for 2,500 V or more, the distance must be 30 cm or more, and for 50,000 V or more, the distance must be 1 m or more.
- (4) Electrical equipment should not be wetted by water, particularly salt water. If it is wet, dry it and measure its insulation resistance with an insulation resistance tester (mega tester) before use.
- (5) Always short-circuit (discharge) both terminals before handling capacitors. When short-circuiting, do not short-circuit directly, but use a resistor or similar device. Capacitors may recover their voltage after a short circuit for a long time, which may cause electric shock. Special care should be taken with

electrolytic capacitors and high-voltage capacitors.

- (6) When measuring power supply voltages with an oscilloscope, wear protective equipment such as electric shock protective gear because the case may be electrically charged and direct touching of the case may cause electric shock.
- (7) When opening and closing a switch, the hand that does not grip the handle should not touch other objects, particularly metal. Operate the switch with the right hand. If you operate the switch with your left hand, you will suffer an electric shock affecting your heart.
- (8) When switching off a circuit with large inductance, such as an electromagnet, sparks may fly and cause burns or electric shock, so wear electric shock protective equipment and protective gear. When turning off the field current of a DC motor, quickly turn off the switch as well.

5 Grounding work

Various types of electrical equipment must be grounded to ensure safety. There are four types of grounding operations: Class A, B, C, and D. The types, resistance values, and grounding locations are listed in Tables 4-4 and 4-5. However, if there are specifications or instruction manuals for the equipment, the instructions should be followed.

Most of the grounding terminals of the experimental panel are class D grounding. Gas pipes, water pipes, etc. should never be used in place of the grounding terminal. Additionally, do not connect a grounding (earth) wire to the N-pole (grounding side).

Table 4-4 Types of Grounding tasks, grounding resistance, and thickness of grounding wire

Type of grounding work	Grounding resistance value	Grounding wire thickness
T y p e A	<10 Ω	diameter >2.6 mm or >5.5 mm ²
T y p e B	Ohms equal to the amperage of one line earth fault current on the high voltage side or special high voltage side of the transformer divided by 150	Diameter 4 mm or 14 mm ² (2.6 mm or 5.5 mm ² when coupling a transformer to a high voltage current or special high voltage overhead power line) or more
T y p e C	100 Ω or less (500 Ω or less when a device that automatically shuts down the power line within 0.5 seconds when a ground fault occurs on a low voltage power line is installed)	diameter >1.6 mm
T y p e D	<10 Ω (same as above)	(same as above)

Table 4-5 Grounding points and types of grounding for various types of equipment

E q u i p m e n t	G r o u n d i n g p o i n t	Type of grounding work
Instrument transformers for low or high voltage exceeding 300 V	Secondary side	Type D
Equipment for low-voltage use below 300 V	Outer box, iron core for those without outer box	Type D
Low-voltage equipment exceeding 300 V	Iron core for those without an outer box or outer casing	Type C
Equipment for high voltage or special high voltage	Outer box, iron core for those without outer box	Type A
Indoor metallic wiring ducts of 300 V or less	Pipes	Type D
Indoor metal wiring ducts exceeding 300 V	Pipes	Type C
Metal wires for indoor wiring	Wires	Type D
Indoor wiring flexible pipe of 300 V or less	Flexible pipes	Type D
Indoor metal wiring duct flexible pipe exceeding 300 V	Flexible pipes	Type C
Metal duct for indoor wiring under 300 V	Ducts	Type D
Metal ducts for indoor wiring exceeding 300 V	Ducts	Type C
Indoor wiring bus ducts of 300 V or less	Ducts	Type D
Indoor wiring bus ducts exceeding 300 V	Ducts	Type C
Floor ducts	Ducts	Type D
Metal device to house captive tire cable	Metal protective equipment	Type D
Metal junction box or metal sheathing for indoor cable wiring of 300 V or less	Junction box, metal clad	Type D
When exceeding 300 V in the preceding paragraph	Junction box, metal clad	Type C
Contact wires for indoor use (e.g., traveling cranes)	Contact wire	Type A
Discharge lamp fixtures of 300 V or less and 1 A or less	Outer box, metal components	Type D
If the value exceeds 1 A in the preceding paragraph	Outer box, metal components	Type C
Electrical machinery and appliances housing incandescent lamps	Metal components	Type D

6 Other hazards caused by electricity

- (1) Use extreme caution when using electric heaters. In addition to scorching the surrounding area at the heater, there is a risk of fire if there are combustibles nearby or through the wire sheath of the main unit. In addition, there is also the risk of electric shock; therefore, be very careful when using this product.
- (2) Do not place flammable or explosive materials near switches, electric motors, distribution boards, or experimental panels. Sparks from blown fuses or interrupted switchgear can cause fires or burns.
- (3) Refrigerators are equipped with an automatic temperature control switch. If the room is filled with explosive gas, sparks from opening and closing the switch may become an ignition source and cause

an explosion; thus, explosion-proof refrigerated storage should be used for refrigerated storage of chemicals.

- (4) In locations where flammable or tributary gases (city gas, hydrogen, acetylene, ammonia, carbon monoxide, oxygen gas, etc.), hazardous materials (alcohol, ether, gasoline, thinners, benzene, etc.), dust (flour, starch, cocoa, milk powder, sulfur), etc. are present, it is recommended that explosion protection measures be taken because overheated equipment, sparks, or arcs when opening and closing switches may become ignition sources and cause explosion accidents.
- (5) In locations where corrosive gases (acids, alkalis, potassium chlorate, bleaching powder, dyes, or places where electrolysis or electroplating is performed, storage battery rooms, etc.) are present, insulation failures and other disorders due to corrosion may occur. Special measures should be taken to prevent easy corrosion and deterioration by using corrosion-resistant materials and equipment or applying anti-corrosion paint, and periodic (yearly) inspections should be conducted to ensure that no corrosion has occurred.
- (6) Whenever a circuit breaker shuts down or a fuse blows, the cause should be investigated, and the circuit should be restored after taking countermeasures. Failure to do so may result in electric shock or fire.

7 Tips related to power failures

Electrical equipment should generally be maintained in anticipation of the inevitability of several power outages per year. Measures to address such situations are described as follows.

- (1) Special consideration should be given to power supplies for electrical equipment and systems that may cause major disasters or disrupt education and research owing to unexpected power outages, such as continuous laboratory equipment, server systems, and cooling systems that are explosion-proof. Specifically, all possible measures should be taken to improve the stability of the power supply, and to set up backup power sources and quickly switch between them.
- (2) In certain types of equipment containing rotating machines, such as old exhaust systems, the load is very excessive when the power is switched back on after a power failure that the rotating machine may be unable to start rotating on its own. In such cases, care should be taken because a fire may occur from the heat generated. In general, equipment (electric furnaces, exhaust pumps, etc.) that must be operated all night in an unoccupied room at night should be equipped with a safety circuit such as a protective relay for each of these devices.
- (3) A flashlight should be stored in an easily accessible place in case of sudden power failure at night, causing darkness.
- (4) In the event of a power failure, switch off the electric motors. DC machines, induction machines, synchronous machines, etc. may burn out when power is restored. In addition, the electric charge of capacitors, etc. should be checked before each use.

8 Special training for handling low-voltage electricity

Only persons who have completed special training for handling low-voltage electricity may perform work such as laying or repairing low-voltage charging lines. (Article 59 of the Industrial Safety and Health Act, Article 36 of the Industrial Safety and Health Regulations)

In addition, even if a person has obtained a second-class electrician's license from the Ministry of Economy, Trade and Industry, he/she must complete the Ministry of Health, Labour and Welfare's special training for electric handling (low voltage) work if he/she is to handle low voltage electrical systems.

Table 4-6 shows the work that can only be performed by those who have been issued a Type 2 Electrician License under the Electrician Act and have completed the Special Training for Handling Low-Voltage Electricity.

Table 4-6 Tasks that cannot be performed without an electrician license

1 Connecting wires
2 Attaching electrical wires to insulators
3 Attaching electric wires to building materials or other objects
4 Fitting electric wires into conduit pipes, wire spines, ducts, and other similar objects
5 Fixing wiring apparatuses to building materials or other objects or connecting wires to them. However, work to replace exposed flashers or exposed outlets is excluded.
6 Bending or threading conduit pipes, or connecting conduit pipes to each other or to boxes and other fittings
7 Attaching boxes to building materials or other objects
8 Installation of protective devices where wires, conduits, spines, ducts, or other similar objects penetrate the construction material
9 Attaching metal conduits, wires, ducts, or similar items, or their accessories to metal laths, wire laths, or metal plate clad parts of buildings.
10 Attaching a distributor board to the building materials
11 Attaching grounding wires to electrical facilities for general or private use, connecting grounding wires to each other or to grounding wires, or burying grounding poles in the ground.

Table 4-7 shows minor tasks that can be performed without a qualified electrician. However, even in this case, the work can only be performed by those who have completed the special training for handling low-voltage electricity mentioned above.

Even in the above work, it is permissible for a non-electrician to assist the electrician when the electrician is working. In addition, a non-electrician may be considered be able to perform any task, including those listed in Table 4-7, except for those listed in 1 through 11 above.

Table 4-7 Minor tasks that can be performed by non-electricians

- | |
|--|
| <ol style="list-style-type: none">1 Construction work to connect cords and captive tire cables to a junction or switch used at a voltage of 600 V or less.2 Screwing electric wires (including cords and cables) to the terminals of electrical machinery and appliances (excluding wiring apparatus) used at voltages of 600 V or less3 Installation and removal of watt-hour meters, current limiters, and fuses for use at voltages of 600 V or less4 Wiring work on the secondary side of small transformers with a secondary voltage of 36 V or less (intercom, electric bell, etc.)5 Installation or modification of poles, braces, etc. to support electric lines6 Installation or modification of underground cables or pipes |
|--|

9 Others

- (1) Electrical wires should not be stepped on, pinched, or used as a substitute for ropes, etc. If there is a risk of such a situation, be sure to attach the prescribed cover. However, it is prohibited to use cords secured with staples or contained in cords, etc.
- (2) When working at heights, use a lifeline or similar device to prevent a fall.
- (3) Avoid working alone with electricity. Work in unoccupied places or at night is strictly prohibited.
- (4) It is dangerous to walk near electrical equipment with long metal rods.
- (5) Refer to Chapter 2 "First Aid" (page 9) for information on how to administer artificial respiration in the event of an electrical accident.

Section 2 Handling of laser equipment

1 Precautions for eyes against light and microwaves

- (1) Do not look directly at laser beam, even if it is weak. Even when not looking directly at it, laser beam may be reflected from window glass, etc., therefore be mindful of reflected light also (Refer to the following “Measures to prevent damage by lasers”).
- (2) Mercury lamps, arcs, etc., contain a large amount of ultraviolet rays, therefore do not look directly at them. In such cases, use safety glasses.
- (3) Microwaves such as from microwave ovens even with a small output are harmful to the eyes, therefore keep eyes away from them.

2 Measures, etc. to prevent injury by lasers

(1) Laser beam features

Laser beam propagates with high energy density because it has a coherent wavefront and excellent directivity, and the spread of the beam is small. Even locations that are sufficiently far from the laser device and thought to be safe may still be dangerous owing to direct strong light or secondary light due to scattering. The wavelength region extends to vacuum ultraviolet, visible, infrared, and millimeter waves. Generally, laser beam is easily absorbed by a living body, and absorption of excessive light energy causes destruction of living tissue, mainly of the eyes and skin, by its heat, photochemical reaction, ionization, etc. There is also a risk of fire if the laser hits a combustible material, therefore use non-combustible curtains in the laser laboratory to prevent fire. Dealing with unwanted light is also important. It should be noted that laser beam neither gets transmitted through a living body like radiation (e.g., X-rays, gamma rays), nor has the accumulation effect proportional to the integrated light irradiation time.

(2) Laser hazards

1) The danger to the eyes depends on the laser output and wavelength.

- ① Laser beam in the far infrared region, such as a carbon dioxide laser (10.6 μm), is well absorbed by water, thereby causing burns on the corneal surface of the eye. Receiving high-power light directly on the skin results in a burn.
- ② Laser beam in the mid-infrared region with a wavelength of 1.4–3 μm reaches inside the eye and causes cataracts.
- ③ Near-infrared and visible lasers (e.g., YAG, semiconductor, titanium sapphire, second harmonic of YAG, and argon ion lasers) have the highest risk of blindness because their beam reaches the retina.
- ④ Ultraviolet lasers (e.g., excimer lasers) light absorbed by the corneal surface causes burns. Skin

cancer and burns can be caused by the direct contact of laser beam with the skin.

2) High-voltage circuits and capacitors are used in the laser body and power supply section, therefore be mindful of electric shocks. Note that the capacitor may not be discharged even when the switch is turned off. Also, be careful of lasers such as excimer lasers that use poisonous gas in their ventilation and exhaust. Ozone and other chemicals are generated in the air by ultraviolet lasers, therefore measures for exhaust gas may need to be taken in the laboratory.

(3) Eye injuries

Lasers have extremely high energy densities and can cause major damage to the human body. The most dangerous case is eye injury. Maximum precautions should be followed to protect the eyes when conducting experiments. The figure below shows various effects of laser beam on the eye.

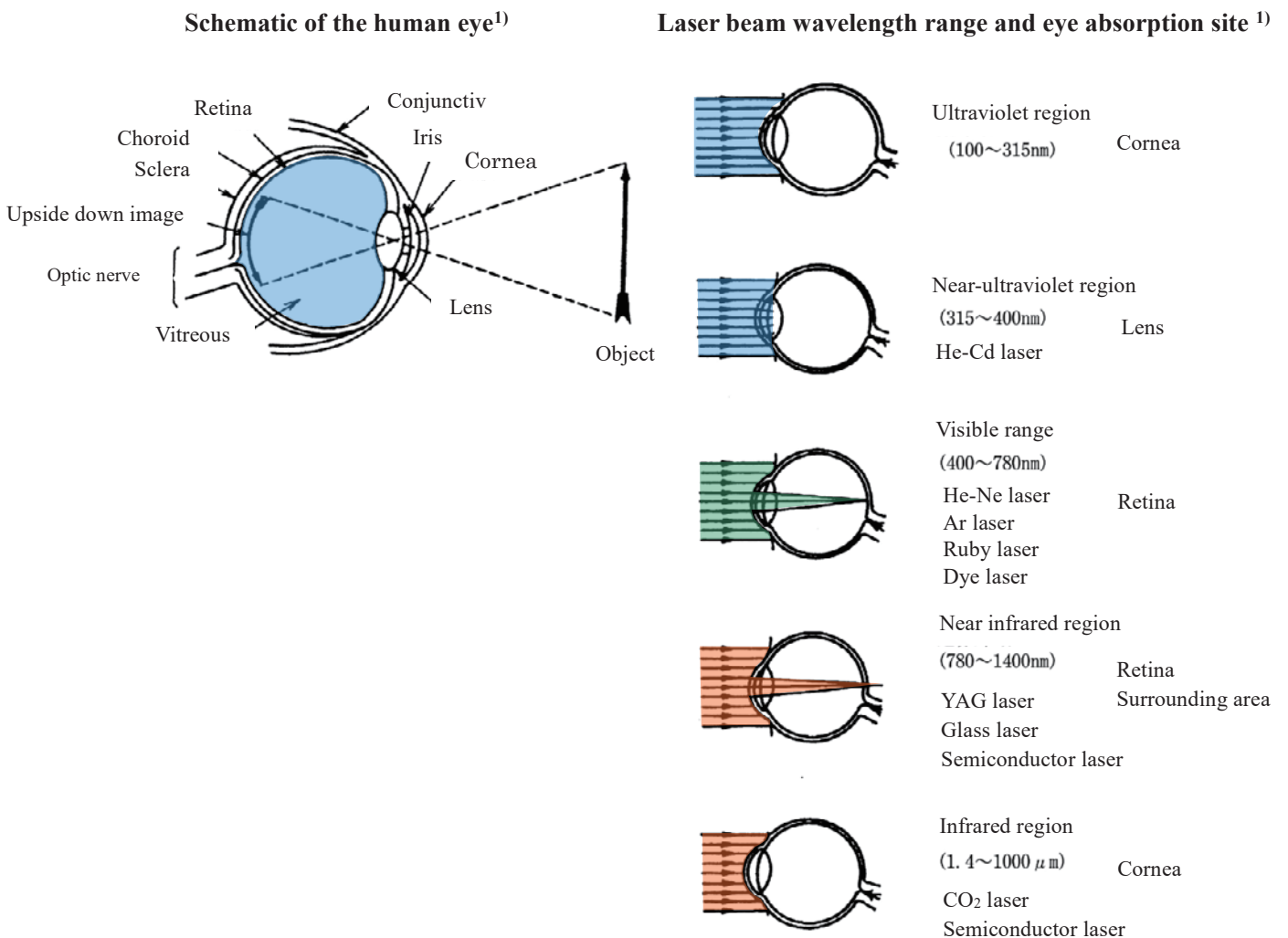

In the case of visible and near-infrared light, the laser beam that passes through the cornea gets focused on a spot on the retina because of the crystalline lens. This spot is as small as beam's wavelength, therefore the energy density becomes significantly high, and the retina gets destroyed causing visual

impairment. The Q-switched pulsed laser can damage the retina even with energies of a few mJ/pulse. In the case of a near-infrared laser such as a YAG laser, the scattered light of the laser beam cannot be seen, therefore precaution must be taken when adjusting laser's optical path, as described later. According to a report that investigated 50 eyes in 43 cases of laser eye injury in Japan²⁾, most of the accidents occurred during experiments in the laboratory, and the university affiliates (staff, graduate students, and undergraduate students) and researchers were responsible for the accidents. The accidents more likely occurred when adjusting the optical axis. In many cases, the misalignment of the laser beam owing to a delicate operation resulted in the reflection of the beam on a side wall, etc., further causing redirection of its path to an unexpected direction, and its subsequent projection on an unintended object. The YAG, titanium sapphire and argon lasers caused accidents.

(4) Laser classification (classification by danger of laser)

A standard value called the accessible emission limit (AEL) is set as a safety measure for laser equipment according to the danger of the laser beam (JIS Standard C6802 "Safety of Laser Products"). This JIS standard was revised on January 20, 2005 (JIS C 6802:2005). Previously, a five-stage laser classification of class 1, 2, 3A, 3B, and 4, in order from the safest to least safe, was adopted. In the revision, a low-class classification was added for laser beams with a large beam spread angle (light output from a semiconductor laser or optical fiber) or for laser beams with a large beam diameter such that the power (energy) density was less than or equal to the maximum permissible exposure (MPE); and the seven stages of class 1, 1M, 2, 2M, 3R, 3B, and 4 were adopted. The contents are summarized below in a comprehensible format. Users should know the class of the laser device to be used.

Class 1 : Either inherently safe or technically designed to be safe. Output is approximately 0.39 μ W or less (in the case of continuous light with wavelength of 400–550 nm), and there is no danger under normal operating conditions. The AEL value is displayed as the power obtained by multiplying the MPE value by limit aperture area. Therefore, even if a laser beam of class 1 or lower is focused by a lens, the power density averaged by the limit aperture area does not exceed the MPE. As a result, the class 1 power limit value is essentially at a safe level, when considering the use of loupes and binoculars. If the amount of exposure to the human body can be limited to the AEL or lower by using enclosures, etc., then the laser will be classified as a Class 1 product, regardless of the output of the **laser** alone.

Class 1M : This class is newly established as "safe to the naked eye". The exposure condition is defined as observing the laser beam with the naked eye at a distance of 100 nm from the light source. Therefore, in this class, observation through a lens system may cause damage.

Class 2 : Low output with visible light (400–700 nm). With a continuous wave (CW) laser, the output is 1 mW or less. It is not inherently safe, but in the case of this class of laser beam,

even accidental eye entry is usually protected by aversive reactions of the eye (i.e., blinking). However, long-term eye irradiation will cause damage. Therefore, do not look directly into the laser beam.

Class 2M : Similar to Class 1M, this is a newly established class where the laser beam is “safe to the naked eye”. It is a Class 2 with limited conditions, where observing the laser with the naked eye (distance of 100 mm) is still safe due to aversive reactions. Therefore, observation through a lens system can result in damage as well.

Class 3R : Using optical means for in-beam observations is dangerous. The beam to the eyes through binoculars can cause damage. The lasers of this class have radiation power of 5 mW or less with CW visible light. The wavelength of visible light is five times the Class 2 AEL or less; the wavelength of non-visible light is five times the Class 1 AEL or less.

Class 3B : Direct or mirror-reflected light is always dangerous and can cause unexpected damage. Never make direct in-beam observations. This class corresponds to visible and invisible lasers with 0.5 W or less for CW lasers, and 10^5 J/cm² or less for pulsed lasers.

Class 4 : High-output lasers that exceed Class 3B, where not only direct and mirror-reflected light but also diffuse reflections are dangerous. The laser beam of this class causes eye and skin damage. There is also risk of fire.

Note: JIS C 6802:2005 was amended in 2011 to the latest version as JIS C 6802:2011.

(5) Safety management of facility equipment

- A warning label must be placed on the room where a laser device of Class 2 or higher is used.
- If there is a laser device in the research/laboratory, display the label on entry/exit door on the hallway side.
- For laser equipment of Class 3B or higher, install a warning indicator (laser in use) that can be identified from the outside during use.

(6) Principles for safe use of lasers

Considering the abovementioned concepts, it is thought that the precautions for using the laser safely are clear, but general precautions are listed below for high-output lasers of Class 3B or higher.

1) Wear protective glasses according to the wavelength of the laser used.

Protective glasses have no effect unless they correspond to the wavelength of the laser being used.

Protective glass types include the fully absorbent and partially transmissive types; in the case of a high-power invisible laser, the fully absorbent type should be used.

2) It is strictly forbidden to look directly at the laser beam.

Do not look directly at the laser beam even when wearing protective glasses.

3) The direct and diffused beams are dangerous but the reflected and diffused beam also are dangerous, and ensure that they do not enter the eyes.

- Remove watches, rings, and other items that may reflect light when working.
 - Turn on the lights as much as possible and work in a bright environment (the pupils widen in dark, therefore the amount of light entering the eyes increases).
 - Do not bring your eyes to the height of the beam. Conversely, install the laser optical path such that the beam does not travel at the height of the eyes.
- 4) Do not stand in the laser optical path and its extension.
- There is a possibility that a mirror, etc., might shift or fall into the optical path extension at some instance and result in the laser beam hitting it. Such potential hazards also need to be avoided.
- When possible, it is advisable to cover the optical path of the laser with a non-transmissive flame-retardant pipe.
- 5) Place an absorbent and non-flammable shield at the end of the laser beam.
- Even in cases where there is no risk of fire, such as with a single shot laser or operation for short periods of time, a fire can still break out due to repeated operation or long-term laser irradiation.
- 6) When adjusting the laser or its optical path, reduce the laser output and repetitions as much as possible.
- 7) Avoid exposing the skin directly to the laser beam. Clothes should be made of non-combustible material to reduce the exposure of the skin (chemical fiber garments that melt into beads are not preferred).
- Furthermore, ultraviolet laser beams (e.g., KrF excimer lasers) are highly absorbed by the skin, and even diffused reflected and scattered light cause “sunburns”, therefore use face mask-type protective equipment, and avoid exposure of the eyes and skin, such as the face.
- 8) The laser body and power supply unit have high-voltage terminals and capacitors, and there is a high risk of electric shock. Open the main body and power supply unit only in the presence of an instructor or manager.
- 9) When using the laser, carefully read the manual and ensure correct operation.
- 10) Pay attention to harmful substances that may be generated by laser irradiation, and take appropriate preventive measures. Especially with ultraviolet lasers, pay attention to the generation of ozone in the air.
- Some lasers use harmful and hazardous substances (excimer lasers use halogen gas, dye lasers dyes and solvents, etc.), therefore take care when handling these lasers.
- 11) The Industrial Safety and Health Act describes the specific contents of safety and preventive measures for labor using lasers of Classes 1M, 2M, 3R, 3B, and 4 under “Measures to prevent obstacles caused by laser beams”. These criteria are listed below for reference.

Measure (item only)		Measure	Laser device class				
			4	3B	3R	2M 1M	
Appointment of Laser Equipment Manager			○	○	○※1		
Controlled area (no-entry signs, etc.)		Separated from other areas and clearly indicated by signs, etc., no entry except for those involved	○	○			
Laser device	Laser optical path	Optical path position	Avoid the eye level of the worker	○	○	○	○
		Optical path shielding	Shield with opaque, non-flammable material	○	○	○※1	
		End with fireproof material	Fireproof structure at the end of laser. Anti-reflection / scattering in enclosure	○	○	○※1	○※2
Laser device	Key control		Structure operated by key	○	○		
	Emergency stop switch	Emergency stop switch	Emergency stop switch that can stop the laser beam emission immediately	○	○		
		Alarm equipment	Alarm equipment such as automatic indicator lights that can be easily confirmed	○	○	○※1	
		Shutter	Shutter to avoid unexpected discharge from outlet	○	○		
	Interlock system		Laser beam emission is automatically stopped when the controlled area is opened or the optical path is shielding is released	○	○		
	Outlet display		Display on laser beam outlet	○	○	○	
Work management, etc.	Operating position		Control the laser equipment as far away from the laser optical path as possible	○			
	Optical system adjustment		Use the minimum required power when adjusting the optical system	○	○	○	○
	Protective equipment	Protective glasses	Wear appropriate laser protective glasses for each type of laser	○	○	○※1	
		Protective clothing	Wear clothes with less exposed skin	○	○		
		Use of flame-retardant material	Wear clothes made of flame-retardant material; chemical fibers that melt into beads is not suitable	○			
	Inspection / maintenance		Start-up inspection, regular inspections, adjustments	○	○	○	○
Safety and health education		Education when hiring workers, changing work content, changing lasers	○	○	○	○	

	Health management	Anterior eye examination	Cornea and lens examinations in conjunction with visual acuity examinations when hiring or relocating	○	○	○※1	
		Fundus examination	In conjunction with visual acuity examination when hiring or relocating	○			
Other	Post		Laser equipment manager name	○	○	○※1	
			Dangers, precautions	○	○	○	○
			Laser installation sign	○	○		
		Display of high-voltage parts of laser equipment	Display of high voltage parts, measures to prevent electric shock	○	○	○	○
		Prohibit carry-in of hazardous materials	Explosives, inflammable substances	○	○		
		Harmful gas dust	Measures prescribed by the Industrial Safety and Health Act	○	○		
		Physician's consultation and treatment for suspected laser beam injuries	Immediate medical examination when laser beam damage is suspected	○	○	○	○

*1 Measures are required for laser equipment that emits laser beams outside the 400nm~700nm.

*2 For Class 1M and Class 2M products that output a laser as a parallel beam, measures need to be taken at the end of the laser optical path.

References

- 1) Applied Laser Technology Handbook (Asakura Publishing Co., Ltd., 1991).
- 2) Kamijo Y., Ozawa T., "Laser eye injury in Japan", Japanese Review of Clinical Ophthalmology, 97(2), 95-100, 2003.

Section 3 City gas, tap water

1 City gas

When using city gas in each room, please be mindful of the following points.

(1) Confirmation of ignition and fire extinguishing

- A When igniting, ensure that the burner is completely lit.
- B Ensure complete combustion by the color or smell of the flame.
- C When the gas is ignited, do not leave the site. Also, ensure to extinguish the flame when leaving the site.
- D When extinguishing the flame, ensure that the equipment and gas plugs are closed.

(2) Precautions during use

- A During use, be mindful of ventilation, by checking whether the ventilation fan is always in operation and the air supply and exhaust ports are not blocked.
- B Open the windows at regular intervals for ventilation if there is no ventilation equipment.

(3) Regarding rubber pipes (reinforced gas hoses)

- A Cracked or hardened old rubber tubing should be replaced immediately with a new one, such as a reinforced gas hose.
- B Do not connect a short gas hose with a joint.
- C Insert reinforced gas hose firmly up to the red line of the gas and equipment plugs.
- D Secure the reinforced gas hose with a safety band.
- E When using a one touch-type plug, use an appropriate joint.

(4) Other

- A Keep area around gas equipment tidy, and do not place inflammable materials nearby.
- B If a foul odor or physical discomfort is noticed while using the gas, immediately stop using the gas and open the windows and doors for ventilation.
- C Take diligent care of gas equipment.
- D In the event of an earthquake, immediately close the equipment and gas plugs.

2 Tap water

Tap water is used as various purposes for experimental not only as domestic water. Especially when used for cooling equipment, the correct operation method of the equipment must be followed. The important points for safety are mentioned below.

- (1) The water supply pipe and port of the device are connected by a pipe. If it must be connected with a hose, etc., use a hose that can withstand the water pressure, and firmly fix the connection part between the water supply pipe and port of the device with a safety band so that the pipe does not come off owing to fluctuations in water pressure.
- (2) Electrical equipment and other items that pose a danger owing to water leakage in the laboratory should be placed in advance to avoid the effects of water leakage due to damage or disconnection of hoses and pipes.
- (3) In cases where water leakage to the floor is expected to last a for long period due to an accident, etc., there is a risk of water leakage to the lower floors. Therefore, consider counter measures in advance, such as installing a waterproof pan or a floor drain, and install experimental equipment and piping.
- (4) Tap water should be used while the experimenter is in the room to the extent possible. However, when there is a need for continuous or late-night operation of a device, a display should be placed at the entrance of the room or elsewhere notifying others of this.

Section 4 High-pressure gas, liquefied gas

In general, gas containers, arrangements, valves, etc., are dangerous when destroyed by internal pressure, regardless of the type of gas, therefore their design method is stipulated by law according to the working pressure and size of the container (refer to pressurized container structure standards). Therefore, when using them, the name plate or engraving etc. should be checked so that the specifications and performance of the containers used are suitable for the maximum possible pressure.

1 High-pressure gas container (cylinder)

- (1) A cylinder is manufactured with high-quality steel based on guidelines mentioned in JISB8241. These cylinders are all subjected to pressure resistance tests, airtightness tests, etc., by the High-Pressure Gas Safety Act, and only those passing these tests are used.
- (2) The cylinder has a stamp on the shoulder as shown in Fig. 4-2.
- (3) Outside of the cylinder is painted with a specified color (Table 4-8) indicating the type of filled gas.
- (4) The structure of the valve is shown in Fig. 4-3. The combustible and other gas outlets use the left-hand and right-hand screw are set to the left- and right-hand sides, respectively. Exceptions are helium on the left, and methyl bromide and ammonia on the right.
- (5) The High-Pressure Gas Safety Act does not allow the university to fill cylinders with gas.
- (6) Cylinders should be re-inspected (e.g., pressure resistance, weight) every five years (three years prior to 1989), and the grades should be written on the stamp and container certificate. There are some exceptions for re-inspection such as with small containers of propane (every six years), and if the gas is still in use after five years, the cylinder will be re-inspected during re-filling.

⊕	Container manufacturer code
	O ₂	Filled gas name
AB	1 2 3 4 5	Container symbol and serial number
V	40.3	Internal volume ℓ (actual measurement value)
W	60.1	Container weight kg (without valve and cap)
3,	1 9 7 2	Pressure resistance test date
T. P.	2 5 0	Pressure resistance test pressure pa
F. P.	1 5 0	Max filling pressure (only compressed gas)

Fig. 4-2 Cylinder engravings

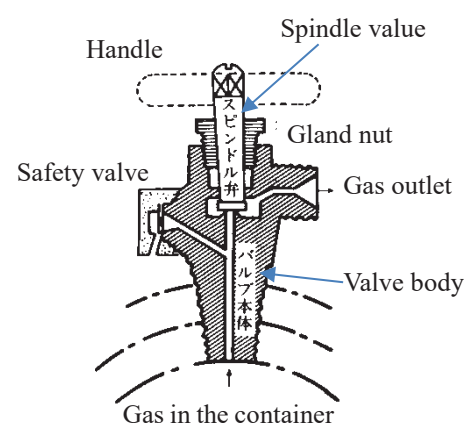

Fig. 4-3 Schematic of a valve

Table 4-8 Cylinder color and gas properties

Gas name	Color	Poisonous	Combustible	State inside
Oxygen	Black	N	—	Gas body
Hydrogen	Red	//	Y	//
Carbon dioxide	Green	//	N	Liquid and gas body
Ammonia	White	Y	Y	//
Chlorine	Yellow	//	—	//
Acetylene	Brown	N	Y	Dissolved gas
Argon	Gray	//	N	Gas body
Nitrogen	// "	//	//	//
Methane	//	//	Y	//
LP gas	//	//	//	Liquid and gas body
Carbon monoxide	//	Y	//	Gas body
Phosgene	//	//	N	Liquid and gas body
Ethylene	//	N	Y	//

2 Precautions for handling high-pressure gas cylinder

(1) General precautions

1. Information

- A The cylinder should be handled by a person with sufficient knowledge or under the guidance of such a person.
- B Various types of gases should be handled after becoming familiar with their properties and methods to handle them.

2. Storage

- C Fix the cylinder at two points on a strong support to prevent it from falling.
- D Combustible gas, poisonous gas, and oxygen should be stored separately, and filled cylinders should be separated from empty cylinders.
- E Always close the valve, and cover the unused cylinders with a cap.
- F Place the cylinder in a well-ventilated area so that the temperature does not exceed 40 °C.
- G When storing cylinders, do not place anything other than the necessary items around them. Also, do not place flames or flammable/ignitable materials within a radius of 2 m from the cylinders.
- H Do not expose the cylinder to wind and rain or place it in a humid place, and take measures to prevent it from rotting. Take measures to avoid exposing it to direct sunlight.
- I Avoid storing the cylinders near electric and ground wires.

3. Movement

- J When moving the cylinder, inspect the valve and be sure to attach the cap.
- K Use a hand cart to move the cylinder, and do not drag or slide the it.

4. Other

L It is desirable to maintain a residual pressure of approximately 1 MPa inside the empty cylinder when handing it to the trader. Never decompress the cylinder. Additionally, transferring gas from cylinder to cylinder is prohibited.

M When disposing of a cylinder that does not pass container inspection, do not abandon it without permission, and always ask a high-pressure gas handling company to dispose of it.

(2) Precautions for combustible gas, oxygen, poisonous gas, and suffocating gas

A Do not use a fire within 5 m from equipment that uses combustible gas (hydrogen, hydrocarbons, etc.) or oxygen, and do not place inflammable or ignitable materials nearby. However, this excludes equipment in the facility.

B Use oxygen after removing combustible substances, such as petroleum and oils, from the equipment. Use a pressure regulator for oxygen only. Do not use inflammable packing material for the connection.

C Ethylene oxide should be consumed after replacing the inside of the equipment with N₂, CO₂, etc. Also, install a backflow prevention device between the cylinder and equipment.

D Conduct activities with sufficient knowledge of poisonous gases. Employ preventive measures in a local exhaust ventilation such as a draft chamber to prevent inhaling of a toxic gas (H₂S, CO, Cl₂, etc.).

E Direct the gas exhaust outside, and make poisonous exhausted gas harmless by passing it through alkali absorbers, etc.

F When using combustible or poisonous gases, installing a gas leak alarm sensor or an oxygen monitor is desirable.

(3) Precautions for silane gas, etc. (silane, disilane, diborane, etc.)

Semiconductor manufacturing involves the use of various chemical substances in the process of CVD, etching, and cleaning; among these, 37 types of gases listed in Table 4-9 in particular are called “special material gases” that exhibit wide explosive range with spontaneous combustibility or decomposing explosiveness; some are also poisonous and extremely hazardous, and these gases should be handled with caution. Of these, the seven types of combustible gases consumed in large quantities (see Table 4-9) require a notification to the prefectural governor prior to their use. Accidents leading to death or serious injury even in university laboratories have been reported, therefore all possible preparation and precautions need to be followed when using these gases, with considering following points:

A House the gas cylinder in a cylinder cabinet, and equip the cabinet with a gas alarm sensor, watering nozzle, and forced exhaust duct.

B Install a compressed air-operated pneumatic valve on the cylinder main plug so that it automatically closes in an event of a power outage or gas leak.

C Use SUS316 for the piping between the cylinder and reaction device (experimental device), and prepare a check valve and nitrogen gas supply system for purging.

- D Install experimental and gas supply equipment in a sufficiently safe manner. Install a gas alarm sensor in the upper part of the room and an exhaust duct in the ceiling.
- E If possible, install a security power supply in the laboratory.
- F Connect the exhaust side of the experimental equipment to the removal equipment, and do not release harmful substances to the outside air. Absorb the reaction and poisonous gases by the adsorption cylinder, but carry out sufficient maintenance and inspection of this removal equipment.
- G Install a fire extinguisher next to or near the laboratory, and ensure that the user is aware of its position.
- H Silane-based gas reacts explosively with an oxidizing gas, therefore the purging gas should not be shared with other gases, and an independent system containing no oxidizing gas should be prepared.

Table 4-9 Special material gases (37 types) and special high-pressure gases (seven types, marked with *) and their properties

Gas name	Chemical	Properties	Gas name	Chemical	Properties
Silanes			Boron trifluoride	BF ₃	
Silane*	SiH ₄	SC	Boron trichloride	BCl ₃	
Disilane*	Si ₂ H ₆	SC	Boron tribromide	BBr ₃	
Dichlorosilane	SiH ₂ Cl ₂	C	Metal hydride		
Trichlorosilane	SiHCl ₃	C	Hydrogen selenide*	H ₂ Se	C
Silicon tetrachloride	SiCl ₄		Germane*	GeH ₄	D
Silicon tetrafluoride	SiF ₄		Hydrogen telluride	H ₂ Te	D
Arsenic			Stibine	SbH ₃	D
Arsine*	AsH ₃	C	Tin hydride	SnH ₄	D
Arsenic trifluoride	AsF ₃		Halides		
Arsenic pentafluoride	AsF ₅		Nitrogen trifluoride	NF ₃	S
Arsenic trichloride	AsCl ₃		Sulfur tetrafluoride	SF ₄	S
Arsenic pentachloride	AsCl ₅		Tungsten hexafluoride	WF ₆	
Phosphorus			Molybdenum	MoF ₆	
Phosphine*	PH ₃	SC	Germanium tetrachloride	GeCl ₄	
Phosphorus trifluoride	PF ₃		Tin tetrachloride	SnCl ₄	
Phosphorus pentafluoride	PF ₅		Antimony trichloride	SbCl ₃	
Phosphorus trichloride	PCl ₃		Molybdenum pentoxide	MoCl ₅	
Phosphorus pentachloride	PCl ₅		Tungsten hexachloride	WCl ₆	
Phosphorus oxychloride	POCl ₃		Metal alkyl compounds		
Boron			Trialkyl gallium	GaR ₃	D
Diborane*	B ₂ H ₆	C	Trialkyl indium	InR ₃	D

Note) C = Combustible in air, SC = spontaneously combustible at room temperature in air, S = combustion-supporting, D = decomposition explosive

3 Precautions for operation using high-pressure gas

(1) Equipment assembly

- A Even for short-term experiments, build a solid stand or frame for the device, and conduct an experiment after the device is safely fixed.
- B Use pressure regulators, pipes, hoses, etc., exclusively for gas, and never divert them. Especially for oxygen cylinders, use a dedicated pressure regulator with the indication of "Oil prohibited".
- C Use a pressure gauge that can handle 1.5 to 3.0 times the normal pressure.

(2) Electrical wiring

Be careful when wiring to avoid explosions and sparks.

(3) Gas leak prevention

Ensure that the equipment is properly connected to prevent gas leakage. For example, in a normal pressure reactor, complete the pipe-to-pipe and device-to-pipe connections. In the pressurized reactor, pay attention to the flange connection, welded part, etc., and in either case, perform a gas leak test using an inert gas such as N_2 before starting the reaction.

(4) Explosion prevention

In a gas reactor, though combustion may occur while pressure is applied and gas is blowing out, there is a risk of drawing in air and causing an explosion inside a device during decompression. Therefore, it is preferable to pipe inert gas such as N_2 to purge the gas inside the reactor with the inert gas. The explosion limits are shown in Table 4-10. When conducting a gas phase oxidation reaction with air (or oxygen) such as hydrocarbons, the explosion limit must be carefully considered. In particular, even if the explosion limit is considered during reactions, the gas concentration may change at the start or end of the reaction and reach the explosion limit. Therefore, please be mindful of the explosion limit concentration and ensure that explosions are prevented.

(5) Gas supply

Install a pressure regulator on the cylinder after confirming that there is no malfunction. Keep in mind that oils on valves and pressure regulators can easily cause a fire. Do not unnecessarily lubricate the pressure regulator.

- A Attach the pressure regulator to the cylinder and firmly tighten its inlet nut. Then, connect the pipe to the outlet of the pressure regulator.
- B If the pressure regulator has an outlet valve, close it. Then, fully turn the control knob of the pressure regulator counterclockwise to close the pressure regulator.
- C Slowly open the valve of the cylinder, and gradually increase the pressure. When the high-pressure gauge indicates full pressure, fully open the cylinder valve.
- D Turn the control knob clockwise and adjust until the outlet pressure gauge reaches the desired pressure. If the regulator has an outlet valve, open it and readjust the outlet pressure if needed.
- E De-gas the pressure regulator after use, and close the cylinder valve, control knob, and outlet valve.

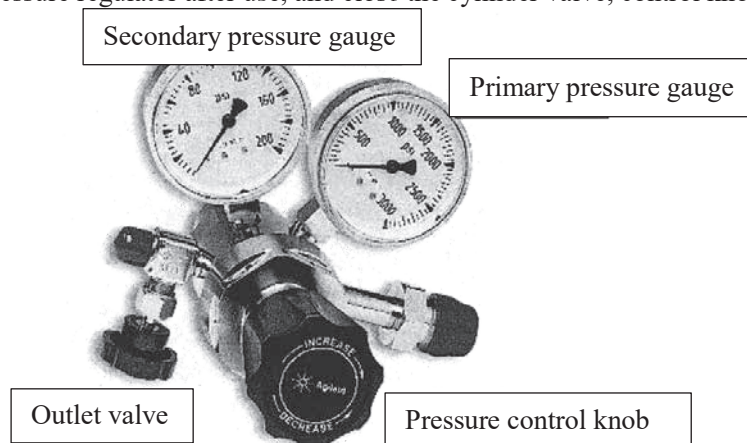

(6) Gas leak confirmation

Check for gas leaks from the connections between the cylinder and pressure regulator, connections between the pressure regulator and device, and the pressure regulator itself. Leaked parts can be easily found by applying a gas leak detection liquid and examining it. Check for leaks by measuring changes in pressure gauge readings.

(7) Equipment material

Select the material according to the type of gas used for the experiment. For example, ammonia corrodes copper, therefore use stainless steel as piping materials.

(8) Exhaust gas treatment

Exhaust gas after the reaction is discharged to the outside. To avoid the risk of gas poisoning, fire, explosion, etc., use methods such as absorption into gas absorbers to prevent other effects.

(9) Deterioration of piping material

If the piping material is used for a long period, it may be deteriorated or damaged by chemicals, light, oxygen, humidity, etc. There is a need for frequent checks and prompt replacements. Replace the gasket used in the pressure regulator as soon as possible.

(10) The mounting position of the pressure gauge should be higher than eye level.

(11) Response in the event of an accident

- A Notify nearby people of the accident and immediately contact the energy center (ext. 2233 or 9290).
- B If poisonous gas is used, wear protective equipment to prevent the occurrence of secondary disasters, and then immediately move the victim to fresh air.
- C Let the victim rest, loosen their clothes, and keep them warm.
- D Give artificial respiration depending on the situation of the victim.
- E Seek help from a physician.

Table 4-10 Explosion limit in air of major gases
(1 atm, normal temperature, upward transmission of flame)

Gas	Lower limit	Upper limit
Hydrogen	4.0	75.0
Methane	5.0	15.0
Propane	2.1	9.5
Butane	1.8	8.4
Ethylene	2.7	36.0
Acetylene	2.5	81.0 *
Ethylene oxide	3.0	80.0 *
Ammonia	15.0	28.0

Note 1) Numbers are volume percentages of combustible gas.
2) *Acetylene, ethylene oxide, hydrazine, etc., may explode even at 100% depending on the conditions.

4 High-pressure devices

When a high-pressure device bursts, debris scattered at high speed and shock waves of rapidly released gas cause major damage to people, equipment, and facilities; additionally, it is often accompanied by major secondary disasters, such as explosions and fires, caused by the gas used and chemicals existing nearby. Therefore, many high-pressure devices are subjected to the High-Pressure Gas Safety Act, and punishments are involved if they are handled without permission.

(1) General precautions

- A Ensure the installation of safety devices and their regular inspections.
- B Perform a pressure resistance test at a pressure 1.5 times or more than normal pressure. The absence of gas leakage beyond the normal pressure must be confirmed, but attention should also be paid to indoor ventilation so that any leakages do not dwell inside the room.
- C Care should be taken to arrange the equipment in the laboratory to minimize the damage to the equipment in case of an accident.
- D Place signs outside and around the laboratory for the outsiders to clearly understand the contents of the experiment and gas used.
- E High-pressure experiments are highly dangerous; user should be familiar with the structure and handling of various devices and equipment before carefully conducting experiments. If there are any suspicious points, refer to specialized books or receive expert guidance.

(2) High-pressure reactor (autoclave)

Carrying out the desired reaction under pressure requires a high-pressure device suitable for it. Reactors, pipes, valves, and instrumentation play their respective roles in the equipment, and their safety factor is considered so that they can withstand corrosion and runaway caused by reactants. Also, choose a place with good ventilation against gas leaks, and use a protective device with good explosion resistance.

When operating the autoclave, perform it at the designated place according to the specified handling method.

(3) Reactor

- A The withstand voltage of the reactor should be designed as approximately twice the normal pressure.
- B Always keep the tightened part of the main body and lid clean regardless of the presence or absence of the gasket. It should be tightened by gradually increasing the force and following the order shown in Fig. 4-4. Do not tighten one side.
- C Replace the air inside the vessel with sufficient amount of nitrogen or the target gas.
- D Depending on the stirring method, be mindful of gas leakage

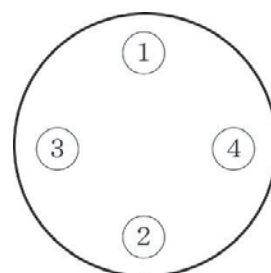

Fig. 4-4 Tightening

from rotating parts and blockage of piping due to catalysts.

E Raw materials must not be charged in more than 1/3rd of the internal volume of the container.

(4) Piping and valves

A Tighten the piping joint by pressing force to prevent the piping from twisting.

B High-pressure valves makes it easy for gas leak from the moving parts (valve spindles).

C Safety valves are of thin plate and spring types etc., and they are used together when it is dangerous.

(5) Pressure gauge

A Always inspect and use accurate instructions.

B Bourdon tube type pressure gauges are often used, but its material should be selected according to the gas used. In addition, oxygen can only be used if it is clearly stated as "Oil for oxygen prohibited".

C A pressure scale that is about twice the normal pressure is easy and safe to use.

D Use a gauge with a safety device. If the gauge has a glass lid, cover it with a wire mesh before using.

5 Liquefied gas

(1) Freezers

A Large refrigerators are subjected to the "High-Pressure Gas Safety Act" and can be operated and maintained only by a "freezer work supervisor". Small freezers are not regulated by law, but should be handled in accordance with the Act.

B The freezers operate at fairly high-pressure, therefore they need to be carefully handled in the same way as high-pressure devices. In addition, correct handling must be ensured based on the type of coolant used.

(2) Cryogenic liquefied gas

A Extremely low temperature causes frostbites. Use leather gloves and wear protective goggles, protective surfaces, etc. If liquefied gas adheres to cloth gloves, it will penetrate into the interior and is rather dangerous.

B Materials become prone to failure due to low temperature brittleness causing a secondary disaster.

C Liquid hydrogen-liquid oxygen, liquid oxygen-fat or hydrocarbon fuel etc. may cause a condensed phase explosion.

D When the liquefied gas vaporizes, its volume expands 800 to 900 times, and it replaces the air at the place of use. There is a risk of suffocation depending on the gas.

E Excessive heat vaporizes the liquefied gas explosively.

F Do not put liquefied gas in a closed container. Ensure that an escape port is available for vaporized gas. Further, even when a safety valve or an exhaust gas vent is provided, moisture or carbon dioxide

gas in the air may be frozen, solidified, and clogged at the ends thereof.

- G Handle the liquefied gas container carefully, and place it in a well-ventilated place away from direct sunlight.

6 Precautions for handling liquid nitrogen

(1) Handling precautions

- A When using liquid nitrogen as cryogen in a closed place such as a clean room, sufficiently ventilate the room to prevent oxygen scarcity. Make sure that the closed area can be seen from the outside, and be sure to conduct experiments with two or more people.
- B Oxygen in air liquefies when liquid nitrogen is used as a freezing bath. Since liquid oxygen is extremely dangerous, traps and like should not be left in liquid nitrogen for a long time in an open system.
- C Always cover open containers. In closed containers, close the booster and liquid take-out valves, and open the gas release valve.
- D Liquid nitrogen that has been used for a long time and evaporated and decreased should not be used for cooling organic matter because oxygen is concentrated. As the oxygen content increases, it becomes bluish liquid.
- E The liquid nitrogen storage container has a weak neck, therefore do not lay it on its side. It is also vulnerable to shocks, therefore handle it carefully.
- F Use a metal container exclusively for liquid nitrogen. Wrap tape around the outer circumference of a bare glass dewar bottle.
- G When taking out liquid nitrogen from the storage tank, first slightly open the take-out valve, sufficiently cool the inside of the container with the low-temperature gas that comes out, and then gradually open the valve to take out an appropriate amount of liquid nitrogen.
- H Do not sprinkle liquid nitrogen on the edge of the dewar bottle.
- I Consider the degree of shrinkage of equipment and piping due to cooling.
- J Do not touch liquid nitrogen or low-temperature metal parts directly with bare hands.
- K Storing liquid nitrogen (boiling point 77K) for a long time in a wide-mouthed container can result in the mixing of oxygen (boiling point 90K) from the atmosphere and accumulation of liquid oxygen. Oxygen ignites violently when it comes in contact with organic matter, therefore take care when handling fire even around liquid nitrogen.

(2) Guidelines for transporting low-temperature liquefied gases such as liquid nitrogen by elevator.

- A When transporting low-temperature liquefied gases such as liquid nitrogen by elevator, avoid riding with ordinary people as much as possible.
- B Do not transport low-temperature liquefied gas such as liquid nitrogen in a state where it can easily scatter in the elevator or when the container is open.
- C Take measures to prevent the container from tipping over in the elevator, and handle it gently.

7 Precautions for handling liquid helium

- A Liquid helium, which is normally used as a freezing bath, has a mass number of 4 and chemical formula of ${}^4\text{He}$. The boiling point of liquid helium is 4.2K, and the heat of vaporization [J/cm^3] is extremely small, approximately 1/60th of that of liquid nitrogen, and it should be noted that even if there is a slight inflow of heat from the outside, it will evaporate rapidly and expand in volume.
- B Liquid helium is contained in a vacuum-insulated metal container. Since its center of gravity is high, there is a risk of falling. When moving, hold the handle in the center near the center of gravity, not the top of the container, and take care not to tip the container over. Furthermore, the inner container is an extremely thin special metal container (expensive) to minimize the heat inflow from the outside. The cylinder is also almost suspended in the neck, therefore prone to breakage, and this should be handled carefully to avoid impacts.
- C At the time of the experiment, it is advisable to attach a rubber balloon to the evaporation gas discharge port for evaporation monitoring. However, if air flows back from the discharge port, it solidifies inside the container (neck part of the container) and the container gets blocked, therefore care must be taken.
- D A dedicated transfer tube is used to transfer liquid helium, and the transfer should be conducted while carefully following the precautions or instructions of those who are accustomed to its transfer. Also, when storing liquid in a liquid helium container, pay sufficient attention towards confirming the opening and closing of the safety valve installed at the top of the container, securing the lid of the liquid helium supply port and gas discharge port (micropores).

Section 5 Electric Furnaces

1 Precautions when using electric furnaces

The safety precautions when using an electric furnace are as follows.

- (1) Confirm that there are no flammable substances, combustible gases, etc. around the furnace.
- (2) Confirm that the thermocouple for temperature measurement is installed in the specified position.
- (3) Read the manual carefully, and check the operation and procedure. If unavailable, receive guidance from an administrator.

- (4) Do not insert the sample more than the capacity of the furnace or damage the furnace body, core tube, etc.
- (5) Keep an eye on the electric furnace while in use.
- (6) Do not apply overvoltage during heating. Do not raise the temperature above the capacity of the furnace.
- (7) Wear gloves when handling high temperature objects.
- (8) Wear safety clothing, safety shoes, and protective glasses for dangerous work such as heat treatment.
- (9) When operating a device unmanned, set up a display with the user details, work details, and contact information.
- (10) At the end of the work, make sure that the furnace temperature is at a sufficiently safe low temperature.

Section 6 Safety precautions of machine tools

1 General safety precautions of machine tools (*Must be read carefully before work as a precautionary measure!!)

(1) Regarding clothing

- A Work in clothes that will not get caught in the machine. Loose shirts, hanging towels around the neck and hips, exposed ties and towels around the neck are extremely dangerous.
- B Wear safety shoes (conforming to JSAA A type or JIS S type) when using the work center. Safety shoes are protective equipment in the event of accidental dropping of heavy objects or stepping on tools or chips.
- C Wear a cap and protective glasses when using Center for machining technology development. Depending on the work content, a mask may be used. If in doubt, follow the instructions of instructors and managers.
- D Do not use gloves in machine tool work as they are easily caught in the machines.

(2) Installation/removal of workpieces

- A Be mindful during attachment/detachment to and from the machine, as it is easy to pinch fingers or cause contact injury due to blades.
- B Do not forcibly install and remove heavy items alone; instead, do so with multiple people or with a lifting device.
- C When processing articles with complicated or unstable shapes, use jigs and appropriate fasteners to securely attach them.

(3) Machine operation

Strictly observe the safety precautions for each machine

- A When the installation of an item is completed and when operating the machine, clear the surrounding area of unnecessary tools and make it safe before starting the work.
- B At the start of work, idle the machine to determine the quality of the attachment of the workpiece and tools and the condition of the machine. When operating, do not enter the direction of movement of the machine, rotating plane, or within the dangerous area of the machine.
- C While operating the machine, concentrate on the work and stay near the machine.
- D Be sure to turn off the main switch when leaving the machine.
- E Do not stop the machine with the automatic feed set, or stop the machine while the tool and the workpiece are in contact with each other.
- F Always pay attention to the sound, vibration, and heat of the machine; if there are any abnormalities, immediately stop the operation and notify the staff of Center for machining technology development.
- G Do not stop the inertial movement of the machine with hands, feet, tools, etc.
- H Collaborative work should involve ensuring the safety of oneself and proceeding with the work while paying attention to the surroundings, such as preventing injuries to others by calling out to them when needed.
- I If the machine breaks down or an abnormality is found, immediately contact the staff of Center for machining technology development and receive the necessary instructions.
- J Avoid mechanical work during overwork as much as possible.
- K When operating the machine, it is advisable to utilize the Internet etc. to study the necessary background before starting the work (the machining center is equipped with teaching materials for machining, which should be effectively used).
- L If there is a sudden power outage during processing, turn off the main power of the machine you are using, and then follow the instructions of staff of Center for machining technology development.
- M Ensure sufficient safety when recording measurements using a machine.

(4) Regarding chips

- A Chips are as sharp as a blade. Do not dispose of with bare hands, instead use appropriate tools such as brushes and pliers.
- B Longer chips are more likely to be wrapped around the workpiece, which may damage the work or prove dangerous to the human body. Dispose of the chips in a short period of time.
- C Chips that are scattered on the floor may stick to the soles of the feet or cause tripping or slipping. Clean up during every work break.
- D For work where chips are scattered and easily get into the eyes (such as grindstone work), use an appropriate cover or wear protective glasses.

2 Precautions regarding the handling of various machine tools (read the relevant parts carefully before starting work!!)

(1) Lathe work

- A Wear work clothes with tight sleeves and hem to prevent them from getting caught in the machine.
- B Assume a work posture where the chips do not enter the eyes. Wear protective glasses when processing materials that scatter chips.
- C When installing/removing chuck and flats, lay a board on the bed in advance to prevent injuries or mechanical damage even if they are dropped.
- D If the chuck claws must be stuck out while working, then manually turn the spindle before starting the operation to prevent the claws from touching the bed or tool post.
- E Do not leave the handle or fastener attached to the chuck or flat. Remove it immediately after use.
- F Installation/removal of tools/workpieces and measurement of geographic features should be performed by stopping the machine and put the gear in neutral or turning off the power supply.
- G Do not touch or wipe the rotating machine or workpiece with hands or cloth. Especially on rough processed surfaces, there is a danger of the cloth being caught or the fingertips getting cut.
- H Stop the machine and dispose of chips wrapped around blades and workpieces using appropriate tools.
- I Do not place unnecessary tools or materials on the bed.
- J Install the bite as short as possible. Long protrusions cause the tool to bite excessively on the workpiece.
- K Do not install work that deteriorates the accuracy of the chuck or chuck claws.
- L For thin and long workpieces, mounting and cutting conditions should be considered sufficiently.

(2) Milling machine work

- A Install/remove the workpiece and measure the machined part when the machine is stopped.
- B Do not wipe the surface of the work piece with a waste cloth or hand, or remove chips while the blade is rotating.
- C Consider the direction of rotation of the blade and acquire a position with no danger.
- D Consider the characteristics of the blade and try to process materials reasonably.
- E Safely change the spindle and feed by stopping the rotation.
- F Rapid feed should be performed after checking the position of the blade and the condition of the workpiece.
- G Try to use the central part of the base when sandwiching the workpiece between the vise.

(3) Drilling machine work

- A Make sure to attach the workpiece to the fixed table to prevent it from swinging around.

- B Take special care to avoid swinging when drilling small workpieces, thin plates, or soft materials.
- C There is a high risk of swinging when the hole is drilled in the material and the drill reverses. Clogged chips from deep holes and the use of drills that are struggling to cut the material can also cause swinging.
- D Do not forcibly hold down the swinging workpiece. Immediately stop the machine before taking action.
- E Do not touch the rotating drill or wrapping chips with hands.
- F Do not wear gloves as they may get entangled. Be careful of frayed cuffs.
- G Use a tapered drill or sleeve after wiping it with a clean cloth.
- H When drilling a large hole, lay a plate underneath and securely attach the workpiece to the vise or table.
- I Select a drill shape and drilling tool that matches the material of the workpiece and the size of the hole, and machine under appropriate machining conditions.
- J Ensure to remove the tightening tool from the chuck.

(4) Work using an electric hand drill

- A Drilling with an electric hand drill is dangerous because it uses the force of the arm and the weight of the body, therefore when the hole is drilled, the large torque shakes the body, and the user may lose balance causing a hazard. The work piece may also rotate. Consider the distribution of power.
- B If a bending moment acts on the rotating drill, the drill becomes more prone to failure and becomes dangerous. Ensure that the drill is perpendicular to the machined surface.

(5) Grinding machine work

The replacement of the grinding wheel or implementation of a trial run at the time of replacement can only be performed by a person who has completed the special education stipulated in the Industrial Safety and Health Act.

- A When turning on the grindstone rotation switch, do not stand in direction of its rotation.
- B Let the device idle for 1 to 2 minutes after turning on the grindstone rotation switch. Incidents where the grindstone breaks and flies often occur during this time.
- C Roughness, clogging, and imbalance on the surface of the grindstone are extremely dangerous, therefore if noticed, immediately contact the staff of Center for machining technology development.
- D When attaching unstable workpieces such as those with small contact surfaces or tall ones to the magnetic chuck, use blocks, vices, angle plates, etc. to securely attach them.
- E Carefully check the positional relationship between the grindstone and work piece when using rapid feed.
- F Process with an appropriate cutting depth, and do not forcefully grind the workpiece.

- G Workpiece installation/removal and measurement work should be done in a safe place by stopping the rotation and separating it from the grindstone.
- H Always wear protective glasses.
- I After use, be sure to idle the grinding stone for approximately 5 minutes to prevent any grinding fluid absorbed by the grindstone from being left.

(6) Die-sinking and wire electrical discharge machines

Consult with the staff of the work center before using the machine.

- A Chips entering the electrical discharge machine may cause unstable processing; therefore to thoroughly remove the chips, blow air with a machine that is installed in the worksite.
- B Stable electrical discharge machining cannot be sustained if there is an insulating material such as black-dyed leather, therefore remove this in advance.
- C Workpieces cannot be positioned and stable electric discharge machining, so remove with a file or a grindstone.
- D Severe oil stains are also unfavorable for electrical discharge machining, therefore wipe them off with a waste cloth.
- E To prevent electric shock, do not touch the electrodes during processing.
- F To prevent fire, set the liquid level 50 mm or more above the top of the workpiece.
- G When a problem occurs, press the emergency stop button and promptly report to the staff of Center for machining technology development.

(7) CNC machine tools such as machining centers

Before using the machine, consult with the staff of the work center.

- A Check the NC program thoroughly. If necessary, perform computer simulation to confirm NC operation.
- B Make sure that there is no tool interfering the NC program path.
- C Do not touch the machine operating range during operation.
- D Select a tool that matches the material of the workpiece, and machine under appropriate machining conditions.
- E When a problem occurs, press the emergency stop button and promptly report to the staff of Center for machining technology development.

(8) Grinder

The replacement of the grinding wheel or implementation of a trial run at the time of replacement can only be performed by a person who has completed the special education stipulated in the Industrial Safety and Health Act.

- A Grindstones rotating at high speed are dangerous when unbalanced or have deformed surfaces. If

such abnormalities are noticed, immediately contact the staff of Center for machining technology development.

- B Do not stand in front of the grindstone for about 1 to 2 minutes when it starts.
- C Use only the work surface of the grindstone, and do not work on other surfaces.
- D Use the device with a space of 1–2 mm or less between the grindstone and cutting table.
- E Forcibly pressing the workpiece is incorrect and dangerous.
- F Take care not to let small workpieces scatter over the workspace.
- G Do not work while wearing gloves or wrap the workpiece with a cloth. Gloves and cloth can become entangled.
- H Use protective glasses to protect eyes from flying abrasive grains and chips.

(9) Sample cutting machine

The replacement of the grinding wheel or implementation of a trial run at the time of replacement can only be performed by a person who has completed the special education stipulated in the Industrial Safety and Health Act.

- A Make sure that the amount of cutting fluid is appropriate.
- B The selection of the grindstone is important for the wear and cutting accuracy of the grindstone. Please be sure to check this. If the grindstone needs to be replaced, please contact the staff of Center for machining technology development.
- C Do not process small or thin objects that may enter the cutting escape groove. This may damage the grindstone.
- D If the grindstone is damaged, stop the machine and promptly notify the staff of the work center.
- E Do not stand in front of the grindstone for 1 minute when it starts.
- F When performing automatic operation, carefully check the rapid feed and cutting positions.
- G Use protective glasses to protect the eyes from flying abrasive grains and chips.
- H To cut, rotate the grindstone, check the discharge of cooling water, and then gently move the cutting lever. Adjust the cutting speed while referring to the cut meter pointer.

(10) Saw work

- A Securely attach the workpiece when sandwiching it between a vise. Pay particular attention while installing unstable materials.
- B Select the blade and processing conditions suitable for the shape and material of the workpiece and work. When having difficulty making a choice, ask the staff of Center for machining technology development.
- C Pour an appropriate amount of cutting oil to prevent the surroundings from becoming dirty.
- D If you need to replace the blade, contact the staff of Center for machining technology development.

(11) Band saw work

- A Periodically inspect the welded part of the blade to make sure that it is safe.
- B If the blade needs to be replaced, contact the staff of Center for machining technology development.
- C When any abnormalities such as an unstable cut surface are found, notify the staff of Center for machining technology development.
- D Use the provided presser to cut small workpieces.
- E Process at an appropriate cutting speed without forcibly pressing the workpiece against the blade.

(12) Pressing and shearing work

- A Pressing and shearing work is injury-prone, which can cause amputation of fingertips. Please conduct these tasks carefully.
- B When cutting the sheet metal with a shearer, attach it securely using an appropriate tool such as a presser foot. Do not touch the area near the blade or presser.
- C Materials that exceed the cutting capacity of the machine are not to be handled.

(13) Gas welding and fusing work

Welding, fusing, and heating of metals using combustible gas and oxygen can only be done by those who have completed the gas welding skill training stipulated in the Industrial Safety and Health Act.

- A Do not operate the oxygen container, regulator, torch, etc., with oil or grease on your hands or gloves.
- B Make sure to connect the adjuster, torch, conduit, etc. using a fastener. Inspect each joint for leaks using soapy water.
- C In a case of backfire during work, immediately close the oxygen valve of the torch and then close the acetylene valve.
- D Check the nozzle that caused the backfire and ignite again if there are no abnormalities. If a backfiring repeats, replace the nozzle.
- E Use the built-in cleaning stick to clean the nozzle. Large deformed holes can cause backfire.
- F Gas welding and fusing may cause burns due to the scattering of high-temperature molten metal. Wear protective glasses, gloves, hats, apron, etc.
- G Do not work near inflammable objects.

(14) Shielded metal arc welding work

Arc welding can only be done by those who have completed the special education stipulated in the Industrial Safety and Health Act.

- A Prevention of injuries caused by electric shock
 - ◇ Use insulating gloves and footwear.
 - ◇ Do not work while wearing wet work clothes (due to sweat or water).

- ◇ Use completely insulated holders.
 - ◇ Ensure that the power supply of the welding machine is turned off when stopping work.
- B Prevention of injuries caused by harmful rays
- ◇ Use a light-shielding surface when looking at intense rays of the arc. Viewing the arc with the naked eye can result in electricity-induced eye inflammation.
 - ◇ Use hand shields and protective glasses for work, and if necessary, use helmets, leather aprons, arm pads, and foot covers.
 - ◇ Do not roll up the sleeves of work clothes or work with open-chested clothes.
 - ◇ Use a screen to prevent the scattering of arc light to prevent harm to other workers.
- C Prevention of injuries due to welding smoke
- ◇ Sufficiently ventilate the work room.
 - ◇ Use dry welding rods.
- D Prevention of other disasters
- ◇ When touching the welded part directly with hands, be sure to touch it after checking the temperature to avoid burns.
 - ◇ After finishing using welding rods, confirm that their temperature has dropped, after which discard them in a designated location.
 - ◇ Do not work with combustible gas or highly inflammable materials nearby.

3 Precautions when malfunctions or injuries occur in various machine tools and work equipment (important as a follow-up measure!!)

(1) Malfunctions of machine tools and work equipment

- A In case of even a slight unusual discomfort from information obtained from eyesight, hearing, or smell during work, contact the staff of Center for machining technology development and receive instructions.
- B If the machine breaks down or an abnormality is found, promptly contact the staff of the work center and receive the necessary instructions.
- C If there is a sudden power failure during processing, turn off the main power supply of the machine that is in use, and then follow the instructions of the staff of Center for machining technology development.
- D For any malfunctions due to inattentiveness rather than the machine life or sudden accident, inform the staff of Center for machining technology development in detail about the reason for the malfunction, the process, etc., to avoid recurrence.

(2) Injuries, etc.

- A In a case of sustaining an injury during work, contact the staff of the work center and receive necessary first aid, appropriate treatment, and other instructions from the appropriate individual (i.e., person instructed by staff of Center for machining technology development).
- B To avoid recurrence of similar accidents, report the reason, process, and situation of the injury to the staff of the work center as soon as possible after the completion of treatment.

*** Attention!**

The most frequent accident at the center for Machining Technology Development in the university is a “fingertip” injury.

The injuries in machining work using lathes, milling machines, grinding machines, drilling machines, saws, etc., occur due to:

- ◇ Inadvertent contact with sharp blades
- ◇ Processing chips with bare hands
- ◇ Workpieces swinging or flying off due to board being set in an unstable manner.

Most of the injuries were mild, such as those requiring emergency bandages, but some of them were serious, that needed a month for complete recovery. Many of these were just one step away from finger amputation. To enjoy the satisfaction of completing a product, please ensure to carefully read the “Safety precautions of machine tools” and work very carefully to avoid injuries.

Section 7 Transportation and work at heights

Transportation work includes work using cranes, derricks, chain blocks, and other lifting devices and transport vehicles. Additionally, when working at heights, stepladders and ladders may be used to climb roofs etc.

Devices such as cranes can only be operated by those who have a license or qualification, and those without them are not to conduct this kind of work.

High-elevation work refers to work done at a height of 2 m or more from the ground or floor, and work must be done with multiple people wearing safety belts and hard hats.

This type of work often involves multiple workers and has high risk of accident-based injuries. Therefore, instructions and instruction system during work need to be clarified. Work involving the transportation of heavy objects should be done under a single instructor.

1 Work that requires specified licenses, qualifications, etc.

The following types of work, which have a high risk of harm, must not be conducted by an individual unless they have a specified license or qualification stipulated for that work.

- (1) Work involving the operating or slinging of cranes with a lifting load of 5 t or more, mobile cranes, or other lifting equipment, and derricks with a load limit of 5 t or more.
- (2) Work involving lifting with lifting equipment with a limit load of 1 t or more, cranes with a lifting load of 1 t or more, or mobile cranes and derricks.
- (3) Work involving the operation of vehicle-based construction machinery (e.g., for leveling, transportation, loading) with a body weight of 3 t or more.

2 Work other than the above

Work involving operations that do not require a specified license or qualification cannot be conducted by instructors or students unless they have undergone special training of risk prevention regarding the structure, function, work method, handling of equipment, and risk prevention provisions.

3 Work with cranes, derricks, and chain blocks etc.

- (1) These are used for lifting or moving heavy objects and are operated electrically or manually. However, only authorized individuals are to be engaged in the operation or other work, and the following precautions should be sufficiently followed:
 - A Do not touch the power supply equipment.
 - B Be sufficiently far from under or near heavy objects during lifting/lowering and moving work.
 - C Operate according to the worker's instructions and observe the hazardous work until an unqualified

person is allowed to assist.

D Individuals should seriously take the utmost care towards their physical safety.

- (2) Individuals other than the driver should avoid chattering or fooling around and pay close attention to prevent accidental personal injury due to inattentiveness. Do not let the person ignoring this warning engage in related work or experiments.
- (3) People engaged in this work should wear safety caps (helmets), safety shoes, and clothing that is suitable for work.

4 Work with transport vehicle

Private car should not be used for research, education, etc., but if it must be used, then please observe the following precautions:

- (1) To avoid accidents due to fatigue and busyness, give sufficient consideration especially when transporting to a distant location, and follow the instructions of an instructor such as riding or driving with two or more people.
- (2) Load the cargo as low as possible and properly fasten the same. Do not overload the vehicle.
- (3) Do not stack material on one side, and ensure that the items do not stick out of the vehicle body.
- (4) Load heavy items first and light items later.
- (5) Use a danger sign when transporting hazardous materials and large items.
- (6) Have a lookout or signaler in a particular need.

5 Work at heights

- (1) Be well-prepared and well-positioned, and never conduct unreasonable or hazardous work. Always have an observer.
- (2) Pay attention to scaffolding; always use a lifeline such as a safety belt, and confirm the safety of the support part of the lifeline.
- (3) When working on the roof, pay particular attention to feet placement. Prepare tread especially in the case of a slate. Also, be especially careful when passing over beams.
- (4) Never use slippery footwear when conducting high-elevation work.
- (5) Do not underestimate situations when working at elevations. Even slightly elevated areas can cause death if an individual falls.
- (6) When using scaffolding, roofs, lifelines, ladders, etc., make sure that they are sufficiently safe before starting work.
- (7) When using force for work at high elevations, avoid using more than half the force that would be used on the ground.
- (8) Do not lift or carry heavy objects on scaffolding or roofs.

(9) Precautions regarding ladders

- A Use ladders that are durable, not too long, and well-suited for the task. When hanging a ladder, choose a location where the scaffolding is solid, avoid places in front of hinged doors and places where people may pass along corridors, and have an observer at the base. An angle of around 15° with respect to the wall is appropriate.
- B Do not use ladders when they are wet or oily and in a slippery state. Additionally, do not use items that may break the crossbar.
- C Going up and down a ladder should be done alone. Do not hold any items while doing so.

Section 1 Chemicals and handling precautions

1 Hazardous, harmful, and general chemicals

This university is engaged in leading and original research as well as advanced technology education. An extensive range of chemical substances are used in research experiments including hazardous chemicals that can lead to human damage and fires and harmful chemicals that cause health problems if not used properly. The former is regulated by the Fire Service Act, and the latter by the Poisonous and Deleterious Substances Control Act., and the Pollutant Release and Transfer Register (PRTR) system of the Act on Confirmation, etc. of Release Amounts of Specific Chemical Substances in the Environment and Promotion of Improvements to the Management Thereof, which aims to control the emission of specific chemical substances into the environment, requires the management and recording of the usage and emissions of such substances (please refer to page 18 and the URL below for each of these laws and regulations).

Fire Service Act URL:

<https://elaws.e-gov.go.jp/document?lawid=323AC1000000186>

These laws and regulations need to be adhered to when handling and storing chemicals, and the supervisor and experimenter must be very careful to ensure that the experimenter and people around them are not at risk. To manage medicines in an effective manner in accordance with these laws and regulations, the university introduced the **management system for lab chemicals** (IASO) in AY2008, which also conducts online management. According to this system, specified poisonous substances, poisonous substances, and deleterious substances must be managed by weight, whereas other chemicals must be managed by unit. It is imperative to comply with these laws and regulations.

System URL: <http://iaso.nagaokaut.ac.jp/iasor7/fw/FW0000/>

System usage URL:

https://www.nagaokaut.ac.jp/gakunai/designated/jinji_romu/yakuhinkanri/index.html

Before using chemicals, the user is expected to be aware of their physical and chemical properties, the hazards, harm to health and environment, and first aid measures in the case of emergency. These are **listed** in the **Safety Data Sheet (SDS^{Note}**, see page 18, “Regarding SDS stock”), which should be read before handling any chemicals. The **SDS** can be viewed in the above chemical management support system, and it

is also posted on the chemical manufacturer’s homepage and can be downloaded. In an unlikely event of a **user needing to visit a hospital or other medical institution due to a chemical accident**, it is advisable to **bring a copy of the first aid measures for the chemical listed on the SDS**. The university’s “Safety inspection list” also requires maintenance and utilization of the **SDS**.

Note: The SDS was called the MSDS in Japan until FY2011, but in accordance with the Globally Harmonized System of Classification and Labeling of Chemicals (GHS), Japan also changed the name to SDS and is also mentioned as SDS in the Japanese Industrial Standards (JIS Z7253).

Furthermore, since June 2016, the Industrial Safety and Health Act has mandated implementation of risk assessments for over 640 types of chemical substances. At our university, we have posted the measures for the risk assessments of the chemical substances in the following URL. When using the substance in question, there is a cautionary statement in IASO about the substance being subjected to risk assessment, therefore it is imperative to ensure that the necessary safety measures are followed before using it.

https://www.nagaokaut.ac.jp/gakunai/designated/jinji_romu/RA/RA.html

Table 5–1 shows the hazardous, harmful, and general chemicals considering the actual circumstances of education and research at the university.

Table 5-1 Hazardous, harmful, and general chemicals

A Hazardous chemicals

Name		Fire Service Act: applicable items	Order for Enforcement of Industrial Safety and Health Act, Appendix 1: applicable items
Combustible substances	Strongly oxidizing substances	Category I hazardous materials	Hazardous materials: oxidizing substances Some explosive substances
	Spontaneously combustible substances	Considerable amounts of the category III hazardous materials, yellow phosphorus, hydrides, organometallic compounds and organometallic hybrids	Hazardous materials: combustible substances
	Low-temperature ignitable substances	Category II hazardous materials	Hazardous materials: some combustible substances
	Water-reactive substances	Category III hazardous materials, considerable amounts of spontaneously combustible organometallic hydrides	Hazardous materials: some combustible substances
Explosive substances	Explosives	Category I and V hazardous materials	Hazardous materials: some explosive substances
	Decomposition explosive substances	Explosives, Category I hazardous material peroxides, and other unstable compounds	Hazardous materials: some explosive substances

	Inflammable gases	Among high-pressure gases, inflammable gases, city gas, LPG	Hazardous materials: inflammable gases
Inflammable substances	Special inflammable objects	Category IV hazardous material special inflammable materials	Hazardous materials: inflammable substances
	Highly inflammable substances	Category IV hazardous material Class 1 petroleum and similar amounts of inflammable substances	Hazardous materials: inflammable substances
	Moderate- / low-level flammability substances	Category IV hazardous material Class 2-4 petroleum and similar amounts of inflammable substances	Hazardous materials: inflammable substances
	Decomposition explosive substances	Attention to storage method since this is used in large quantities and constantly	Poisoning countermeasures since this is used in large quantities and constantly
Acids / alkali		Oxidizing liquids are Category 6 hazardous materials	Specified harmful work
Mixed hazardous materials		Regulations on regulations of hazardous materials (Article 46) Important when collecting and treating waste fluid during experiments; take care not to damage bottle during transportation and storage.	Not applicable Often causes an accident. Fire of unknown cause due to chemical, explosion when mixing two types of substances, unknowingly generated unstable substance
Radioactive substances		Act on Prevention of Radiation Hazards due to Radioisotopes, etc.	

B Harmful chemicals

Name		Poisonous and Deleterious Substances Control Act	Pollution and environment-related laws
Harmful chemicals of importance	Locked storage chemicals	Chemicals, drugs, chemicals designated by the Stimulants Control Act, and chemicals that can be easily changed for which	Refer to the contents of the applicable law section recorded in SDS
	Poisonous gases / highly poisonous vapor	Many are designated as poisonous or deleterious The most common cause of laboratory accidents. Ensure that experiments are conducted with two or more people so that an immediate response can be given in the event of an accident.	Air pollutants Detoxification in each laboratory
	Mercury and mercury compounds	Most are poisonous. A few are deleterious substances, and very few are undesignated chemicals. Do not handle organic mercury compounds alone.	

Harmful chemicals	Inorganic harmful chemicals (including organic compounds containing the corresponding element)	Refer to the contents of the applicable law section recorded in SDS	Refer to the contents of the applicable law section recorded in SDS
	Organic harmful chemicals (excluding ordinary organic compounds and organometallic compounds)	Refer to the contents of the applicable law section recorded in SDS	Refer to the contents of the applicable law section recorded in SDS

C General chemicals

Name		Poisonous and Deleterious Substances Control Act	Pollution and environment-related laws
General chemicals	Inorganic chemicals	May seem to be unrelated to the above laws and regulations, but some of them are poisonous, so attention should be given regarding the items described in SDS and similar products.	Refer to the contents of the applicable law section recorded in SDS
	Organic chemicals	See above	Classify and transport according to the "Guidelines for Treatment of Experimental Waste Liquid" of the university.

2 Risk assessment

A risk assessment is mandatory when using a chemical among over 640 kinds of chemical substances after June 2016 according to the Industrial Safety and Health Act. Accidents and health hazards are prevented efficiently before they happen by identifying various potential hazard sources that are present in laboratories and by putting them in order based on their risk in a risk assessment. A precaution that the chemical substance is included in the list of substances subject to risk assessment is displayed on IASO when using one. It must be used with necessary safety measures. Our measures for risk assessments of chemical substances are presented at the following URL:

https://www.nagaokaut.ac.jp/gakunai/designated/jinji_romu/RA/RA.html

The Order for Enforcement of Industrial Safety and Health Act, etc. was amended in February 2022. The rules have been changing from “individual rule for each substance” to rules based on “autonomous management” centered on risk assessments. The future policy has been shown that target substances will be increasing from the initial 674 substances.

Autonomous management of chemical substances means that individuals or organizations themselves properly understand the intrinsic toxicity and danger of chemical substances and risks in handling them, take

measures to mitigate these risks systematically, and prevent accidents such as fire and explosion, health hazards of workers, environmental contamination, and so on.

The Japan Association of National Universities has announced Guidelines for the Autonomous Management of Chemical Substances in Universities: Establishment of Autonomous Management Based on Risk Assessment and Education (Second Edition) in January 2024 as rational measures considering special aspects of studies in universities handling chemicals of various kinds in small quantities. The Guidelines are to be revised corresponding to future amendments made to laws and regulations.

<https://www.janu.jp/univ/guideline/>

Our policy, which maintains research activities and which addresses safety, is under consideration referring to the Guidelines and their future amendments. This chapter cites descriptions in the Guidelines for explanation.

In general, the scope of a risk assessment of a chemical substance covers operating procedures in which it is used and facilities that reduce its toxicity and danger, in addition to its properties (such as toxicity, inflammability and volatility). Operating procedures are also included because the risk posed by a single substance can differ considerably when detailed circumstances of an operation differ. It is therefore important to consider viewpoints of possible trouble in a series of experiment operations, as well as preparations of experimentation facilities to address such trouble, together with the operating procedures of experiments. When a possible risk exists, it is also important to minimize exposure to the target substance. For example, applicable measures include: i) using a substitute; ii) sealing the source of scattering, installing and running a local exhaust ventilation system or general ventilation system; iii) improving the method of operation; and iv) using respiratory protective equipment, etc.

Moreover, some accidents have been caused by substances other than those designated as target substances. It is desirable to identify possible risks of all chemical substances to be handled. Safer environments for experimentation can be made by considering not only chemical substances to be used but also byproducts and wastes to be formed by reaction, etc.

Risks also arise in relation to the storage step. At the times of purchase and storage, consideration of risks such as leakage and fire in cases of disasters such as earthquakes, floods, and power failure is desirable, along with risks of accidents when a room is unattended.

3 General precautions for handling chemicals

A comprehensive plan that starts from purchase to experimentation, storage, treatment, and disposal should be made when a chemical is to be used. Access the university URL shown above and conduct a risk assessment for designated substances. This process leads to prevention of accidents such as fire and

explosion, health hazards of workers, and environmental contamination. Treatment and disposal should follow the rules and directions related to treatment of experimental liquid waste. General precautions for handling chemicals are presented below.

(1) Purchase

- (a) For chemicals designated as hazardous materials in the Fire Service Act, the quantity which can be stored in a laboratory or a building is stipulated in the fire prevention ordinance of the local government. Therefore, do not purchase more than necessary, except for organic solvents that are used regularly.
- (b) For ordinary chemicals, do not purchase chemicals in large quantities, except for chemicals that are used regularly. Data obtained using aged chemicals are not reliable. Some chemicals might deteriorate (by processes such as peroxide formation, moisture absorption, and efflorescence). Purchase a minimum quantity considering disposal after use.
- (c) Prepare a proper experiment protocol. Do not purchase more than necessary.
- (d) After purchase, immediately register in IASO Management System for Lab Chemicals.
- (e) It is desirable to consider risks such as leakage and fire in case of disasters (such as earthquakes, floods and power failure), and risks of accidents when the room is unattended.

(2) Storage

- (a) For storage of chemicals designated as chemicals that must be stored using lock systems, strictly observe the descriptions of the relevant section of toxic chemicals.
- (b) For spontaneously combustible chemicals and water-reactive chemicals such as yellow phosphorus, metallic sodium, metallic potassium and triethylaluminum, store them using a predetermined method, preferably in metallic chemical storage.
- (c) Design the sorting and arrangement of chemical shelves in each laboratory as a whole. Take safety measures for the prevention of danger and fire. At least, store the following chemicals separately from each other: acids and bases; oxidizing agents and reducing agents; and organic chemicals and inorganic chemicals.
- (d) For organic peroxides and special explosive substances, handle with appropriate care. Store them in a cool and dark place separately from other items.
- (e) When substances that must be labeled are transferred into another container and stored, and when they are produced and stored in a container, notify others of their danger and toxicity using methods such as labeling and documents.

(3) Use of local exhaust ventilation system

Measures are needed in a laboratory, such as reduction of the total quantity of chemical substances stored in the laboratory, along with a device to decrease evaporation of volatile chemicals in the room,

in addition to introduction, proper use and maintenance of an exhaust ventilation system. Laboratory control is intended to use these facilities effectively, keep the levels of harmful fumes below the risks of fire and explosion, and maintain an environment that does not affect the health of people who come into the laboratory.

The general performance of exhaust ventilation systems is in the order of local exhaust ventilation system > benchtop hood = scatter preventive measure >> general ventilation fan. Although it is most desirable in a laboratory to conduct all operations using chemical substances in a local exhaust ventilation system, there might be difficulties related to the space, cost or energy consumption. It is therefore important to use a ventilation system that is suitable for the operation methods and for the risk, toxicity, and quantity of the chemical substance to be used.

Evaporation of a single substance can differ depending on factors such as the quantity used, the time of opening the container and contact to the atmosphere, and the area of a container's opening. The exhaust ventilation system should be selected considering the type of use (what kind of container, how it should be handled, etc.). For example, more evaporation occurs and a higher risk of exposure exists when a substance is handled in an open beaker, even for a case in which a substance has less toxicity. For experiment operations that consist mainly of manual operations, selecting and using an exhaust ventilation system that is suitable for the risk level is important for considering the risk assessment based on properties of a chemical substance itself and considering the type of use.

(4) Use of personal protective equipment

Accidental contact to the skin, eyes, etc. with chemical substances is very frequent in laboratories because of scatter, leakage, etc. Eye injury particularly might cause effects such as low vision that persist throughout life. Because full prevention of scattering, leakage, etc. is difficult when handling chemical substances, selecting and wearing appropriate protective equipment is important to prevent accidental contact to the skin, eyes, etc. Risk of contact to chemical substances is ever present. Do not forget to wear personal protective equipment not only during experiments but also before experiments, such as when weighing materials, and after experiments, such as during disposal and cleaning. Personal protective equipment is described as the following.

Safety glasses: Operators who handle chemical substances must wear safety glasses irrespective of the quantity of the chemical substances used. Glasses for vision correction are not personal protective equipment. Users of glasses for vision correction must wear safety glasses that can cover the area around the eyes, such as protective overglasses.

Protective gloves: Operators who handle chemical substances must wear protective gloves of materials selected to reduce the risk of contact to the chemical substances to be handled, considering resistance

to permeation and heat, fitting, grip, etc.

Protective clothes: Operators who handle chemical substances must wear protective clothes such as white coats and work clothes. Select protective clothes of a size and shape to avoid skin exposure, assuming protection against scattering of chemical substances. Select clothing while considering fire resistance if a significant risk of fire exists.

Footwear: Operators who handle chemical substances must wear appropriate footwear to cover the entire foot. Footwear must be resistant to permeation by the chemical substances to be handled. Sandals, shoes with air vents or high heels, slippers, etc. are inappropriate.

Respiratory protection: Respiratory protection is a protective device to wear for the purpose of protecting respiration when chemical substances harmful to the body are present in the environmental air. The work environment should be improved by ventilation, etc. to reduce harmful chemical substances in the environmental air as a prior condition. Wear respiratory protection to prevent substances from entering the body when protection from the chemical substances is insufficient merely by improving the work environment. Various types of respiratory protection against chemical substances can be used, such as protection with fans, facepieces, gas masks, and air-supplied respirators. Select devices that are effective considering the hazards posed by operations.

Protection during experiments with risk of fire, explosion, bursting, etc.: For experiments posing a risk of scattering of chemical substances and fragments by fire, explosion, bursting, etc., operators must wear eye, head, and body protection. Select antistatic protection as appropriate. Use measures such as protective screens to minimize damage in the case of an accident.

(5) During handling/reaction

When an operator handles the designated chemical substances, etc. for the first time, conduct a risk assessment at the time of planning of the operation (before conducting the operation). The designated substances are indicated as such by our IASO Management System for Lab Chemicals when entered. A risk assessment can be conducted for most of about 670 of the chemical substances using the results disclosed in the university's in-house web. The level of exposure must be minimized using the local exhaust ventilation system, personal protective equipment, etc. based on risk assessment findings. Handle with risk reduction measures shown in the following as appropriate.

- (a) When using a dangerous substance, or when a reaction product is predicted to be a dangerous substance, perform an advance experiment using small quantities.
- (b) When handling volatile chemical substances, avoid handling them to the greatest extent possible in a state that is open to the atmosphere. Use methods to minimize the chances for volatile chemical substances to evaporate. For example: minimally open the lid of the container; and do not use containers with a large opening, such as a beaker, for organic solvents.
- (c) When using dangerous substances, or when conducting dangerous reactions, consider protective

measures against disasters in advance. Conduct them under appropriate arrangements. Wear a face shield, prepare a fire extinguisher, and use the local exhaust ventilation system as appropriate when a risk of fire or explosion exists. Wear rubber gloves and a gas mask when the substances are toxic.

- (d) It is most desirable if all operations using chemical substances are conducted in the local exhaust ventilation system. Use an exhaust ventilation system that is appropriate for the danger, toxicity, and quantity of the chemical substances to be used, and the operation methods. It is desirable to perform operations on a safer side. Control operations to avoid danger such as fire and explosion, and to keep from creating vapors that are harmful to the body filling the space to a level that can lead to difficulties.
- (e) Explosion, fire or acute intoxication might occur during experiments. Do not conduct experiments alone or late at night, but during the daytime.

(6) Treatment and disposal

Accidents occur frequently not only during an experiment but also after the completion of an experiment. Risk assessments should include disposal and cleaning up.

- (a) Dangerous chemicals, toxic chemicals, and general chemicals must be treated and disposed of in accordance with the rules and directions of the university based on the intentions of the disaster prevention and fire prevention ordinances of the local government, the Water Pollution Prevention Act, the Air Pollution Control Act, and the Offensive Odor Control Act, referring to the relevant sections.
- (b) Waste that is left over after experimentation presents risks of unexpected accidents. Wear safety glasses during operations of disposal, treatment, transfer, etc. Similarly, wear safety glasses, protective gloves, protective clothes and footwear to cover the entire foot when handling wastes such as transferring containers. During disposal, toxic gases, and other substances might be produced by the unintentional mixing of chemical substances: prepare appropriate respiratory protection, etc. as an effective safety measure.
- (c) When a bottle becomes empty, immediately conduct empty bottle processing in an IASO Management System for Lab Chemicals to delete its registration.

(7) Hazardous materials handler qualification

As a general rule, it is necessary for us to record a hazardous materials handler's qualification when handling hazardous materials. Therefore, when in a course or major that involves frequent handling of hazardous materials, it is desirable to obtain a hazardous materials handler license. In particular, universities and research institutes handle a wide variety of chemicals, therefore the Class A license needs to be obtained. The eligibility criteria for the Class A license are that one must have two years of work experience after acquiring the Class B license, or graduated from a chemistry department at a technical college or university or have taken a prescribed number of chemistry courses.

4 Limits on possession and handling of hazardous materials

The storage and handling of hazardous materials is stipulated by the Fire Service Act and local fire prevention ordinances. The Fire Service Act generally prohibits the storage or handling of hazardous materials over a certain quantity. This standard quantity is called the **designated quantity**. Here, a rank of the danger is created according to the properties of the hazardous material, and a quantity is specified by Cabinet Order for each rank, which is then used as the designated quantity.

Hazardous materials are classified by the Fire Service Act from Category I through VI according to their properties, as shown in Table 5-2; and the designated quantity is determined according to the danger of that category. If the quantity of the stored hazardous material is 0.2 times or more than the designated quantity, a notification must be submitted to the fire department; and at our university, with the exception of the hazardous materials storage for which a notification has been sent to the fire department, less than 0.2 times the designated quantity can be stored and handled by each building (strictly speaking, it is “less than 0.2 times the designated amount for each fire protection area”. The fire protection area differs depending on the structure of the building, therefore the case where the scope of the fire protection area is widest is described here). Therefore, the storage and handling of hazardous materials in the laboratory needs to be kept to the minimum necessary amount. Cases where this is exceeded must involve storage in the hazardous material storage.

Multiples of the designated quantity of multiple types of hazardous materials are calculated by the sum of the multiples of each hazardous material, as shown in the following equation, and the sum cannot exceed 0.2.

$$\sum_i m_i / M_i < 0.2 \quad m_i : \text{Possessed quantity of each item, } M_i : \text{Designated quantity of that item}$$

Table 5-2 Appended table of hazardous materials (category, name, and designated quantity are from the Fire Service Act)

Category	Nature	Item	Nature (law)	Designated quantity (law)
Category I	Oxidizing solids	1 Chlorates	Class 1 oxidizing solids	50kg
		2 Perchlorates		
		3 Inorganic peroxides		
		4 Chlorites		
		5 Bromates		
		6 Nitrates	Class 2 oxidizing solids	300kg
		7 Iodates		
		8 Permanganates		
		9 Dichromates		

		<p>10 Other substances specified by a Cabinet Order (periodates, periodic acid, chrome/ lead or iodine oxides, nitrites, hypochlorites, chlorinated isocyanuric acid, peroxydisulfates, peroxyborates, sodium hydrogen carbonate additives)</p> <p>11 Substances containing any of those listed in the preceding items</p>	Class 3 oxidizing solids	1,000kg
Category II	Combustible solids	<p>1 Phosphorus sulfide</p> <p>2 Red phosphorus</p> <p>3 Sulfur</p>		100 kg
		4 Iron powder		500kg
		<p>5 Metal powders</p> <p>6 Magnesium</p> <p>7 Other substances specified by a Cabinet Order</p>	Class 1 combustible solids	100kg
		8 Substances containing any of those listed in the preceding items	Class 2 combustible solids	500kg
		9 Inflammable solids		1,000kg
Category III	Spontaneously combustible substances and water-reactive substances	<p>1 Potassium</p> <p>2 Sodium</p> <p>3 Alkyl aluminum</p> <p>4 Alkyl lithium</p>		10kg
		5 Yellow phosphorus		20kg
		<p>6 Alkali metal (excluding potassium and sodium) and alkaline-earth metal</p> <p>7 Organometallic compounds (excluding alkyl aluminum and alkyl lithium)</p>	Class 1 spontaneously combustible substances and water-reactive substances	10kg
		<p>8 Metal hydrides</p> <p>9 Metal phosphides</p> <p>10 Carbide of calcium or carbide of aluminum</p>	Class 2 spontaneously combustible substances and water-reactive substances	50kg
		<p>11 Other substances specified by a Cabinet Order (chlorinated silicon compounds)</p> <p>12 Substances containing any of those listed in the preceding items</p>	Class 3 spontaneously combustible substances and water-reactive substances	300kg

Category IV	Inflammable liquids	1 Special inflammable materials		50 L
		2 Class I petroleum	Water-insoluble	200 L 400 L
		3 Alcohol		400 L
		4 Class II petroleum	Water-insoluble	1,000 L 2,000 L
		5 Class III petroleum	Water-insoluble	2,000 L 4,000 L
		6 Class IV petroleum		6,000 L
		7 Oil extracted from plants and animals		10,000 L
Category V	Self-reactive substances	1 Organic peroxides 2 Nitric esters 3 Nitro compounds 4 Nitroso compounds 5 Azo compounds 6 Diazo compounds 7 Hydrazine derivatives 8 Hydroxylamine 9 Hydroxylamine salts	Class 1 self-reactive substances	10kg
		10 Other substances specified by a Cabinet Order (metal azides, guanidine nitrate, 1-allyloxy-2,3-epoxypropane, 4-methidene oxetane-2-one) 11 Substances containing any of those listed in the preceding items	Class 2 self-reactive substances	100kg
Category VI	Oxidizing liquids	1 Perchloric acid 2 Hydrogen peroxide 3 Nitric acid 4 Other substances specified by a Cabinet Order (interhalogen compounds) 5 Substances containing any of those listed in the preceding items		300kg

Remarks

- The term "oxidizing solids" means solids (substances other than liquids (i.e., substances forming liquids at a temperature of 20 degrees and one atmospheric pressure, or substances liquefied at a temperature exceeding 20 degrees but not higher than 40 degrees and one atmospheric pressure; the same applies hereinafter) or gas (i.e., substances forming gasses at a temperature of 20 degrees and one atmospheric pressure); the same applies hereinafter) that, as a result of an examination for determining the potential risk of oxidation conducted pursuant to a Cabinet Order, demonstrate the nature specified by a Cabinet Order, or that, as a result of an examination for determining the

- sensitivity against impact conducted pursuant to a Cabinet Order, demonstrate the nature specified by a Cabinet Order.
- 2 The term "combustible solids" means solids that, as a result of an examination for determining the risk of ignition by fire conducted pursuant to a Cabinet Order, demonstrate the nature specified by a Cabinet Order, or that, as a result of an examination for determining the risk of inflammability pursuant to a Cabinet Order, demonstrate inflammability.
 - 3 The term "iron powder" means iron powders excluding those specified by an Order of the Ministry of Internal Affairs and Communications after considering the particle size and other factors.
 - 4 Phosphorus sulfide, red phosphorus, sulfur, and iron powder is deemed to demonstrate the nature specified in item 2 of these Remarks.
 - 5 The term "metal powders" means powders of metals excluding alkali metal, alkaline-earth metal, iron and magnesium, and also excluding those specified by an Order of the Ministry of Internal Affairs and Communications after considering the particle size and other factors.
 - 6 With regard to magnesium and the substances listed in item 8 of the row of Category II containing magnesium, those specified by an Order of the Ministry of Internal Affairs and Communications after considering the form and excluding other factors.
 - 7 The term "inflammable solids" means solid alcohol and any other solid whose flash point is lower than 40 degrees at one atmospheric pressure.
 - 8 The term "spontaneously combustible substances and water-reactive substances" means solids or liquids that, as a result of an examination for determining the risk of ignition in air conducted pursuant to a Cabinet Order, demonstrate the nature specified by a Cabinet Order, or that, as a result of an examination for determining the risk of ignition or generating combustible gas upon contact with water, demonstrate the nature specified by a Cabinet Order.
 - 9 Potassium, sodium, alkyl aluminum, alkyl lithium and yellow phosphorus are deemed to demonstrate the nature specified in the preceding item.
 - 10 The term "inflammable liquids" means liquids (with regard to the Class 3 petroleum and Class 4 petroleum and oil extracted from plants and animals, limited to those forming liquids at a temperature of 20 degrees and one atmospheric pressure) that, as a result of an examination for determining the risk of inflammability conducted pursuant to a Cabinet Order, demonstrate inflammability.
 - 11 The term "special inflammable materials" means diethyl ether, carbon disulfide, or any other liquid whose ignition point is 100 degrees or lower at one atmospheric pressure, or, whose flash point is minus 20 degrees or lower and boiling point is 40 degrees or lower at one atmospheric pressure.
 - 12 The term "Class I petroleum" means acetone, gasoline, and any other liquid whose flash point is lower than 21 degree at one atmospheric pressure.
 - 13 The term "alcohol" means saturated monovalent alcohol whose molecules are composed of between one and three carbon atoms (including denatured alcohol), excluding those specified by an Order of

the Ministry of Internal Affairs and Communications after considering its composition and other factors.

- 14 The term "Class 2 petroleum" means heating oil, gas oil, and other liquids whose flash point is 21 degrees or higher but lower than 70 degrees at one atmospheric pressure, excluding paint or other materials specified by an Order of the Ministry of Internal Affairs and Communications after considering the composition and other factors.
- 15 The term "Class III petroleum" means heavy fuel oil, creosote oil, and other liquids whose flash point is 70 degrees or higher but lower than 200 degrees at one atmospheric pressure, excluding paint or other materials specified by an Order of the Ministry of Internal Affairs and Communications after considering the composition.
- 16 The term "Class IV petroleum" means gear oil, cylinder oil, and other liquids whose flash point is 200 degrees or higher but lower than 250 degrees at one atmospheric pressure, excluding paint or other materials specified by an Order of the Ministry of Internal Affairs and Communications after considering the composition.
- 17 The term "oil extracted from animals and plants" means oil extracted from the grease, meat, etc. of animals or the seeds or pulp of plants, whose flash point is lower than 250 degrees at one atmospheric pressure, excluding those stored and retained pursuant to the provisions of an Order of the Ministry of Internal Affairs and Communications.
- 18 The term "self-reactive substances" means solids or liquids, that, as a result of an examination for determining the risk of explosion conducted pursuant to a Cabinet Order, demonstrate the nature specified by a Cabinet Order, or that, as a result of an examination for determining the extent of thermolysis conducted pursuant to a Cabinet Order, demonstrate the nature specified by a Cabinet Order.
- 19 With regard to the substances listed in item (xi) of the row of Category V, those containing organic peroxides and also those containing an inactive solid as specified by an Order of the Ministry of Internal Affairs and Communications are excluded.
- 20 The term "oxidizing liquids" means liquids that, as a result of an examination for determining the potential risk of oxidation conducted pursuant to a Cabinet Order, demonstrate the nature specified by a Cabinet Order.
- 21 With regard to any substance having two or more natures listed in the column of the Nature in this Appended Table, the Item that covers those substances are specified by an Order of the Ministry of Internal Affairs and Communications.

5 Hazardous materials storage

The storage and handling of hazardous materials is strictly stipulated by the Fire Service Act and government ordinances/rules regarding the regulation of hazardous materials. According to these

stipulations, storing hazardous materials in the designated quantity or higher other than at a specified storage location is prohibited. **Each experimental building of the university can hold and handle less than 0.2 times the designated quantity in each fire protection area, and a hazardous material storage is installed to store more than this quantity** (see p.78, “Limits on possession and handling of hazardous materials” for details). Hazardous material storage rooms are divided according to the type and nature of hazardous materials.

The maximum amount of hazardous materials that can be stored in university storage is 24 times the designated quantity, and the actual handling method is specified in the Nagaoka University of Technology Hazardous Material Storage Handling Guidelines. **Furthermore, the storage period in the hazardous material storage of the university is set to one year, and storage over longer period is prohibited as a general rule.** Therefore, when purchasing hazardous materials, an experimental plan should be established to avoid purchasing an unnecessarily large amount of hazardous materials. Also, the hazardous material storage is not for storing unnecessary chemicals, therefore chemicals that are not expected to be used should be disposed of immediately in accordance with regulations.

6 When starting a new experiment

When starting a new experiment, there is a high possibility of an unexpected accident such as an explosion, hence each experimenter and experiment instructor must observe following precautions before starting an experiment.

- (1) Conduct an extensive investigation of experimental examples.

Investigate the hazards and toxicity of all related substances such as raw materials, products, solvents, and byproducts. Refer to “<Important> Regarding SDS stock”, “Reference URL”, and the relevant parts of this chapter on pp. 18–19.

A Literature search

The research report is not an experimental guidebook. It should be noted that hazards are not necessarily mentioned.

B Listen to the stories of experienced people.

- (2) Establish an experimental plan to prevent accidents.
- (3) Furthermore, even in the unlikely event of an accident (e.g., erroneous operation, abnormal reaction, material defect, power outage while absent, water outage, secondary damage from nearby accident, earthquake), exercise caution to prevent casualties.
- (4) Discuss the experimental plan and disaster prevention measures in the laboratory.
- (5) Install the necessary safety protection equipment.
- (6) First conduct a preliminary experiment with small amounts. During this time, ensure to establish sufficient measures such as protective equipment and walls.
- (7) Do not shift to a large quantity in the experiment at once; make a gradual shift.

7 General precautions for chemical experiments

There are chemicals, various instruments, and equipment in the chemistry laboratory, and each must be used appropriately. First, carefully read the general handling precautions that are described in Section 1.2 regarding the purchase, storage, use, and disposal of chemicals. Special laboratories require designing of suitable safety precautions. Ensure that laboratory members imperatively obtain safety education and fire prevention training.

(1) General precautions

- A Keep the laboratory tidy and clean.
- B Always keep fire extinguishers, protective equipment (safety glasses, protective masks, gloves, safety guards, etc.), eyewash stations, first aid tools, and chemicals (first aid kits) available.
- C Regularly inspect for aging electrical wiring, loose terminals, and poor insulation.
- D When handling substances that are expected to be hazardous, thoroughly investigate their hazards and toxicity in advance, consult with experienced people, and consider measures that would minimize damage even in the event of an accident.
- E For hazardous chemicals, specify the product name so that there are no errors.
- F Do not wash containers, equipment, etc., without proper ventilation.
- G The following experiments require special attention.
 - Operations and reactions that include unknown hazards
 - Operations and handling of substances with a wide variety of hazards
 - Experiments wherein the possibility of ignition and harmfulness coexists
 - Experiments under reaction conditions that are close to the limit (high pressure, high temperature, low temperature, and vacuum)
- H When conducting experiments that are expected to be hazardous, inform the surrounding people in advance and take proper measures.
- I Use protective glasses. If further hazards are expected, use protective equipment such as gloves, protective mask, gas mask, and safety screens.
- J Treatment of chemicals and waste after experiments
 - Store solutions containing heavy metals, cyanide compounds, arsenic, strong acids, and strong alkaline solutions in containers according to the guidance of the university's experimental waste liquid processing.**
 - Do not pour organic solvents down the drain.** Collect what can be recovered to the extent possible, and either use or dispose it.
 - Combustible waste such as filter paper should be soaked in water before discarding in a "disposal pot".
- K Even in experiments that are generally expected to be hazardous, students can become inattentive

after repeating it several times owing to familiarity and carelessness. Always carefully examine the equipment used, quantitative relationships, reaction conditions, etc., and start the experiment in a composed yet careful manner.

- L Confirm the position of the fire extinguisher (e.g., carbon dioxide, powder type) and sand (types and characteristics of fire extinguishers are shown in Tables 5-3 and 5-4).
- M Wear lab coats and work clothes to prevent skin exposure. Ensure that nimble movements can be made. Avoid wearing sandals or slippers.
- N Do not purchase more chemicals than necessary. Store all chemicals that are not being used in the experiment in a chemical cabinet that is away from the laboratory table. Keep the organic and inorganic chemicals separated from each other when in storage.
Place only the necessary items and required amount of chemicals on the laboratory table. Placing extra reagents, solvents, etc., can lead to larger-scale accidents.
- O Before starting an experiment, inspect the laboratory equipment, experimental equipment, piping, wiring, etc., as a safety check.

(2) Precautions during experiments

- A When conducting experiments, **do not make a full schedule**. It is better to suspend an experiment if it does not advance according to the plan. Do not rush an experiment.
- B **Do not leave the laboratory during experiments**. When leaving the laboratory, clearly state the experiment content and destination to someone in the same room.
- C When distilling, do not forget to add boiling stones. If they were forgotten, put them in after cooling.
- D When there is a risk of explosion, do not cover the device to seal it. A screen that separates the device from the experimenter is preferable.
- E When opening a lid of a bottle, point the plug in a direction where there is nobody present.
- F When crushing substances, be careful not to cause an ignition or explosion due to friction or impact.
- G Please be careful if a so-called mixed hazardous material (see Section 2.5, p.107) that could ignite or explode is present when mixing two or more types of substances.
- H Do not try to handle an accident alone. Seek help.
- I **Do not pour mercury or its compounds down the drain.**

(3) Clean up

- A Cleaning up is also part of the experiment.
- B Immediately wash the used equipment, especially grinding equipment. Be careful when disposing of cleaning waste liquid. Insufficient cleaning can more likely result in accidents by the time the experiment resumes.
- C Dispose of used chemicals according to the specified method. Clarify the content of used chemicals and solutions, and be mindful of the storage method.
- D Ensure that the chemical label on the bottle does not come off. It is preferable to write on the bottom

of the bottle with a permanent marker.

E The disposal of old chemicals is prone to inattentiveness. Patiently dispose of them.

(4) Precautions when leaving and conducting experiments late at night

A Stop the gas, electricity, and water when leaving. Pay particular attention in cases of a day before the weekend.

B Take measures against unexpected water pressure changes, water outages, and power outages. In particular, items for which measures cannot be taken, such as an aspirator (attached backflow prevention bottle) and cooling water, should not be operated unmanned.

C Late night experimentation is not permitted as a general rule, but when such experiments are unavoidable, pay close attention to the use of heating and ventilation.

D There should be at least two people in the laboratory, but if temporarily alone, ensure that the at least person in the laboratory is known. Leaving the door open is an option.

E When conducting experiments or deskwork at night or on weekends, or operating equipment late at night, obtain permission from the academic supervisor by notifying remaining after-hours and unmanned operation late at night, and display them at the designated locations (refer to Appendix 1 on p.3).

Table 5-3 Fire extinguishers to adapt

Class	Type	Main fire extinguishers to adapt
A	Ordinary fire (wood, paper, fiber)	Powder (A, B, C) fire extinguisher, enhanced liquid fire extinguisher, foam fire extinguisher, water fire extinguisher
B	Oil fire (including semi-solid fats and oils)	Powder (A, B, C) fire extinguisher, enhanced liquid fire extinguisher, foam fire extinguisher, inert gas fire extinguisher
C	Electric fire (converter, transformer)	Powder (A, B, C) fire extinguisher, enhanced liquid fire extinguisher, inert gas fire extinguisher

Note) Class A Fire of ordinary combustibles
 Class B Fire of petroleum or oil
 Class C Fire of electrical equipment

Table 5-4 Fire extinguisher and fire equipment

Name of fire	Chemical	Applicable fire	Features
Chemical foam fire extinguisher	Agent A: sodium hydrogen carbonate solution Agent B: aqueous aluminum sulfate solution	A, B	Emits bubbles that contain carbon dioxide. Methods for mixing the two liquids involve either tipping over the fire extinguisher or breaking the inner bottle. Range of approximately 5 m, and once released, cannot be stopped partway. Cannot be used for C fires because there is a risk of electric shock.

Powder (A, B, C) Fire extinguisher	Ammonium phosphate	A,B,C	Can be used for various fires and has great fire extinguishing effects. Range of approximately 4 to 6 m and release time is short. Dirty state present after fire is extinguished.
Enhanced liquid fire extinguisher	Liquefied carbon dioxide	A, B	Can also handle C fires when a spray nozzle is attached. Is a strongly alkaline water system and has a cooling effect. Range of 4-8 m.
Carbon dioxide fire extinguisher	Sodium bicarbonate powder	B, C	Inert gas fire extinguisher. Has a short range of 1–2 m and has the disadvantage of a heavy container but results in less dirtiness after fire is extinguished. Large-scale fire extinguishers in hallways are powerful.
B, C powder fire extinguisher	Dried graphite powder, soda ash, salt, etc.	B, C	Great fire extinguishing effect. Range of 3-6 m, somewhat cumbersome to handle, and heavy. Dirtiness present after fire is extinguished.
Water fire extinguisher	Dry sand	A	Can handle C fires if radiated as a mist. Wetting agent added to give it antifreeze properties.
Fire extinguishing sand	Ammonium phosphate	Metal fire	Effective for alkali metals and alkyl metals, but not suitable for three-dimensional fires.

(5) When a fire breaks out

- A Yell “fire” and let surrounding people know.
 - B Remove nearby combustibles and turn off the fire source.
 - C Turn off the gas source, power supply, etc., as far away from the source as possible.
 - D Extinguish small fires without rushing. Do not make a mistake in this procedure and method (the person at the source of the fire should immediately leave that area and loudly call out for help. Panicking and trying to extinguish the fire alone could result in fire spreading to clothes or flipping over the equipment. It is better to entrust this to another person who is calm).
- Be careful when using a fire extinguisher, as the applicable fire extinguisher will differ depending on the fire type. Fire extinguishers can be classified as Class A, B, or C, and their contents are as listed in Table 5-3. Furthermore, the types and features of general fire extinguishers are listed in Table 5-4.
- Apart for some halon-based fire extinguishers (inert gas fire extinguishers, not currently manufactured) in the Information Processing Center / Doctoral Building, the university is equipped with powder (A, B, and C) and carbon dioxide fire extinguishers (two types in bold in Table 5-4), which are placed in each hallway and room.
- E If a lab coat catches fire, do not panic and take an emergency shower (or use a bucket of water if unavailable) (nylon and polyester blends may melt and adhere to the skin if ignited, which can

result in a serious accident. Cotton or wool is desirable for clothing that comes in contact with skin).

- F Fires in a fume hood are usually extinguished by stopping ventilation because of the fire extinguishing effect and prevention of upward spread of the fire. However, there are some cases where ventilation should be continued, such as when accompanied by the generation of poisonous gases or smoke.
- G If gas is ejected from a inflammable gas cylinder due to an accident, first attempt to close the valve. Additionally, quickly turn off the gas burner to turn off the ignition source, then open the windows to improve the ventilation in the room, and move the gas cylinder near the window if possible.
- H If inflammable gas gets emitted from the gas cylinder and ignites, do not extinguish the fire immediately; first remove surrounding combustibles and then extinguish the fire using a fire extinguisher, water, etc.
- I If there is a risk of poisonous gas or generation of large amounts of smoke, extinguish the fire using protective equipment, smoke mask, etc. At a minimum, extinguish the fire from the windward side.
- J Do not be overconfident when using gas masks. Confirm whether the type of absorption tube in the gas mask is appropriate for use. Furthermore, gas masks are not effective when the concentration of the poisonous gas is more than a certain value. Smoke masks and items like the Aqua Lung are useful.
- K After realizing that the generation of the fire or gas is out of control even after the above measures, immediately leave the premise.
- L Dispose of gas sources, heat sources, hazardous materials, etc., to the extent possible, and check if there anyone who has yet not left the premise.

8 First aid for chemical injuries

(1) Treatment for skin

Immediately wash the affected area with a large amount of clean cold water for at least 15 minutes. For substances that generate heat due to water, such as concentrated sulfuric acid, first wipe off most of the affected area with a dry cloth, paper, tissue paper, etc., as soon as possible, then wash off the rest at once with a large amount of water.

Acids and alkali materials often remain between the folds of the skin and hair, hence neutralize the substance with an aqueous sodium hydrogen carbonate solution for acids and 2-3% acetic acid or lemon juice for alkali materials. Wash phenolic acid with alcohol and neutralize with sodium bicarbonate. Skin ulcers should be treated by a dermatologist.

(2) Treatment for eyes

Quickly wash eyes with a large amount of water. In particular, alkali materials corrode the eyeballs, therefore wash thoroughly with water, and seek immediate medical attention from an ophthalmologist.

A squirt-type eye wash device is good for washing eyes, but if unavailable, immerse the face repeatedly in a basin overflowing with clean water, keep the eyes closed at first, and then repeatedly blink in the water to wash them. Gentle running water from a rubber tube connected to a faucet may be used. However, be aware that a strong fountain can force the acid on the face into the eyes and peel off of the corroded skin surface.

Do not apply neutralizers. After washing the eyes, apply a thick gauze compress, fix this with an eye patch, etc., and immediately receive treatment from an ophthalmologist.

(3) Respiratory treatment

Quickly move the patient to fresh air. Remove contaminated clothing, clean the skin, keep the patient warm, and resting. In severe cases, oxygen inhalation or artificial respiration is required.

Concentrated exposure to acid mist, chlorine gas, etc., not only damages the tracheal mucosa but also the alveoli, which causes bronchitis, pneumonia, and pulmonary edema (plasma exudes into lungs), resulting in respiratory distress. This can also lead to shock, therefore treatment by a physician is necessary.

During emergency rescue, use a gas mask to prevent the rescuer from poisoning. Refer to Chapter 2 of these Guidelines for artificial respiration.

(4) Treatment for accidental ingestion

Have the affected individual drink water or milk in a quantity enough to induce vomiting. Injuries to the stomach and esophagus can lead to death in minutes, therefore an immediate response is required. The amount of water given must be approximately 100 times that of the chemical ingested. Raw eggs can be used for acid, and fruit juice or vinegar can be used for alkali materials. Vomiting can be induced by stimulating the throat with fingers, but there is a choking hazard when the affected individual is unconscious, hence nothing should be done in such cases. Call a physician immediately. Keep the patient warm and resting, and be mindful of shock or respiratory paralysis.

(5) Treatment in case of poisoning

In the event of poisonous gas inhalation, immediately move the affected individual to fresh air, loosen clothes, and rest. Give artificial respiration if necessary. For phosgene, nitrite gas, and halogen poisoning, be sure to rest for several hours, even if there are no complaints of severe pain after gas inhalation. Afterwards, consult with a physician.

In the event of chemical ingestion, drink warm water or saline solution enough to induce vomiting. However, do not allow unconscious people to drink anything.

9 Treatment for various chemicals

Please refer to IASO or the SDS of each manufacturer. Some examples are shown below.

(1) Hydrofluoric acid

This acid intensely corrodes the skin, therefore wash the skin with water for 30 minutes. Subsequently, cover it with a magnesia mud paste (magnesium oxide 20 g, glycerin 80 g), and apply a dry bandage. When the affected individual's respiratory system is disturbed, ensure that the individual is at rest.

(2) Chlorine, bromine gas

For respiratory disorders, have the affected individual smell cotton wool soaked in dilute ammonia water for short periods at a time. Vapor inhalation of a mixture of alcohol and ether in equal proportion also helps relieve airway irritation.

(3) Carbon monoxide

Take the affected individual out into fresh air (do not let the patient walk), and be mindful of rest and heat retention. Cool with ice in the case of fever. Inhalation of oxygen and 5% CO₂ is desirable.

For severely ill people, an exchange transfusion of 2L or more within 30 minutes is effective, therefore immediately arrange for blood transfusion with a physician. After regaining consciousness, the affected individual will need to remain at rest for 2–3 hours and recover over several days.

(4) Hydrogen cyanide, cyanide compounds

Take the affected individual out into fresh air, and if conscious, have the patient inhale amyl nitrite every five minutes for a total of three minutes, stopping once the systolic blood pressure reaches 80 mmHg. This procedure must be conducted within a few minutes. Respiratory arrest requires artificial respiration with 100% oxygen. Percutaneous respiration is possible with hydrogen cyanide, therefore wash the affected area with soap and water and be mindful of keeping the patient warm. There is also a possibility of shock due to amyl nitrite, therefore seek immediate medical attention.

(5) Nitrogen dioxide

Symptoms occur suddenly with a considerable delay after exposure to nitrogen dioxide. Oxygen inhalation is to be continued even if respiratory symptoms are mild. The main symptom is pulmonary edema. Clean the mouth, nose, mucous membranes of the eyes, and skin with 1% baking soda solution.

(6) Hydrogen sulfide

Oxygen inhalation with 5% CO₂ is effective. If in the eyes, wash the eyes and receive treatment from an ophthalmologist.

(7) Phosgene

This causes severe pulmonary edema. Remove the contaminated clothing and wash with 2% baking soda solution. Begin oxygen inhalation as soon as possible. Inhalation of oxygen through 20% alcohol alleviates respiratory distress.

(8) Yellow phosphorus

This chemical tends to cause difficult-to-heal second- or third-degree burns. Rinse with water or a large amount of running water. For burns, pour 5% sodium bicarbonate water, then wash with 5% copper sulfate solution, later remove the phosphorus in the form of solid copper salts using tweezers; however, do not force them off.

(9) Organic solvent

Dangerous acute poisoning is likely to occur with low-boiling-point solvents. Poisoning is mainly due to invasion from the respiratory tract but can also occur due to percutaneous respiration. This generally has an anesthetic effect, and in severe cases, can cause disturbed consciousness and respiratory center paralysis. Patients can become violent during the recovery period.

First aid is the same as with general methods. Use synthetic detergent and water for cleaning. Be careful as sequelae may remain.

(10) Oxygen deficiency

This can quickly be fatal, therefore immediately rescue the affected individual and move them to fresh air. The oxygen concentration in air under which humans can normally operate is 16% or higher; respiratory distress, nausea, and pallor occur at around 10%; unconsciousness and respiratory arrest occur within a short period of time at around 7%.

Use oxygen respirators, lifelines, etc. to avoid rescuers not to be fellow travelers. Gas masks are not effective.

Section 2 Hazardous chemicals

Hazardous chemicals cause serious harm such as secondary chemical burns and lifelong injuries resulting from explosions or flames, which stem from their physical or chemical properties, rather than their inherent toxicity. In addition, except for highly toxic substances, chemicals that possess both hazardous and toxic properties are regarded as hazardous chemicals.

1 Pyrophoric substances

Pyrophoric substances are materials that generally ignite upon exposure to heat, under impact, on contact, or by mixing. Herein, we present substances that are ignited by heat as well as those that ignite with relative ease in the presence of air or water, resulting in fire.

Table 5-5 Pyrophoric substances

Category	Characteristics	Example substances
Oxidants	Decompose under heating and impact to release oxygen; burn violently with combustibles, occasionally resulting in explosions.	Chlorates and peroxides.
Spontaneous pyrophoric substances	Certain prospective substances for research, which ignite and burn in contact with air at room temperature.	Yellow phosphorus, certain sulfides, and metals produced by the decomposition of certain salts.
Low-temperature pyrophoric substance	Ignites at relatively low temperatures and exhibits a high burn rate.	Red phosphorus and metal powder.
Water-prohibitive substance	Ignites in the presence of water and occasionally explodes.	Metallic sodium and potassium.

(1) Oxidants (chemicals)

According to the definition of Class 1 hazardous materials specified in the Fire Services Act of Japan, oxidants are substances that are generally at risk of ignition or explosion from impact, friction, heating, or contact with strong acids. These substances are oxygen carriers, which decompose or explode independently and thus are extremely dangerous. Organic peroxides are particularly dangerous. Potassium chlorate and potassium perchlorate are relatively stable; however, these chemicals may explode when heated in the presence of organic compounds, such as garbage. Such notable substances (chemicals) are listed in Table 5-6; herein, M and R indicate metals and alkyl and aryl groups, respectively.

Table 5-6 Oxidants

Compound	General	Substance (chemical) name	Law or regulation
Chlorates	$M^I ClO_3$ $M^{II} (ClO_3)_2$	Chlorates, such as NH_4ClO_3 , $NaClO_3$, and $KClO_3$ and those of Ag, Hg (II), Pb, and Ba.	Fire Services Act for hazardous materials Class 1.
Perchlorates	$M^I ClO_4$ $M^{II} (ClO_4)_2$	Perchloric acid salts, such as NH_4ClO_4 , $NaClO_4$, $KClO_4$, Mg, and Ba.	Same as above.
Inorganic peroxides	MO_x or Ox , etc.	Na_2O_2 , K_2O_2 , MgO_2 , CaO_2 , BaO_2 , persulfuric acid salts [$(NH_4)_2S_2O_8$, $Na_2S_2O_8$], perboric acid sodium, H_2O_2 , and O_3 .	Same as above. H_2O_2 is a Fire Services Act Class 6 hazardous material.
Organic peroxides	$(RCO_2)_2$, RCO_3H , $(RO)_2$	Explosively decomposing substances such as acetyl peroxide, benzoyl perchloride, peracetic acid, diethyl peroxide, and cumene hydroperoxide.	Fire Services Act Class 5 hazardous material.
Nitric acid salts	$M^I NO_3$ $M^{II} (NO_3)_2$	Nitric acid salts, such as NH_4NO_3 , $NaNO_3$, and KNO_3 and those of Mg, Ca, Ba, Pb, Ni, Co, and Fe.	Fire Services Act Class 1 hazardous material.
Permanganese acid salts	$M^I MnO_4$	$KMnO_4$ and $NaMnO_4$.	Same as above.
Chlorites	$M^I ClO_2$	$NaClO_2$ and $KClO_2$.	Same as above.
Bromates	$M^I BrO_3$	$NaBrO_3$, $KBrO_3$, and $Ba (BrO_3)_2$.	Same as above.
Iodates	$M^I IO_3$	$NaIO_3$, KIO_3 , and $AgIO_3$.	Same as above.
Dichromic acid salts	$M^I_2Cr_2O_7$	$(NH_4)_2Cr_2O_7$, $Na_2Cr_2O_7$, and $K_2Cr_2O_7$.	Same as above.

Handling precautions:

- 1) These substances are at risk of ignition and explosion upon heating, impact, or contact with strong acids. Store oxidants in a cool and dark place away from fire and heat sources.
- 2) Mixing these substances with reducing substances or organic compounds may lead to heat generation, ignition, or explosions owing to oxidation; thus, do not inadvertently mix or store them with other substances.
- 3) Peroxides generate oxygen (O_2) in water and hydrogen peroxide (H_2O_2) in dilute acid, which are generating heat and sometimes ignite.
- 4) Alkali metal and alkaline earth metal peroxides readily react with water; hence, moisture proofing is of particular importance.
- 5) Peroxides may be generated by solvents, such as ether, tetrahydrofuran, or ketone, which undergo autoxidation under normal storage conditions for extended periods; therefore, when distilling such chemicals, either decompose them according to regular procedures or retain a considerable amount of the residual liquid.

Likely occurrences:

- 1) While cleaning organic substances off glass funnels with hydrogen peroxide aqueous solution, peroxides may build up in filter flasks and explode, especially during summer.
- 2) Attempts at peroxide distillation and its implementation in heating solutions may result in explosions.
- 3) When hydrogen peroxide in an aqueous solution is added to manganese dioxide (MnO_2) to generate oxygen, the rapid addition of peroxide causes explosions.
- 4) Inadvertent addition of potassium permanganate, rather than potassium dichromate, during the preparation of chromic acid solution produces explosions.
- 5) The decomposition of organic compounds with perchlorate (HClO_4) solution and sulfuric acid is often accompanied by an explosion in the end.

(2) Spontaneous pyrophoric substances

Spontaneous pyrophoric substances primarily react with atmospheric oxygen under storage conditions or during handling to generate heat; in extreme cases, these substances ignite spontaneously. Such substances are listed in Table 5-7, where M and X indicate metals and halogens, respectively.

Table 5-7 Spontaneous pyrophoric substances

Compounds	General expression	Substance (chemical) name	Law or regulation
Yellow phosphorus	P	Yellow phosphorus.	Class 3 hazardous material.
Hydrides	MH_n $\text{MH}_n\text{X}_{a-n}$	BH_3 , SiH_4 , PH_3 , AsH_3 , SbH_3 , NaH in oil, KH in oil, $\text{BH}_n\text{X}_{3-n}$, and $\text{SiH}_n\text{X}_{4-n}$.	Same as above.
Organometallic compounds	$\text{R}_n\text{MX}_{a-n}$	M = Li, Na, K (these substances are RM type), Mg, B, Al, P, Zn, Se, An, Sb, Bi, Ag, Ca, and Ba.	Same as above.
Organometallic hydrides	$\text{R}_n\text{MH}_{a-n}$	M = B, Al, Si, As, and P.	Same as above.
Metal reduction catalysts	M	Ni (including improved Raney nickel), Pt, Pd, and Cu.	
Fine metal powder		Fine metal (such as Pb and Ni) powder made by the thermal decomposition of oxalates and formates in the absence of air. Fine metal (such as Pb, Ni, and Cu) powder made by the thermal decomposition of metal carbonyls and organometallic, etc. in the absence of air.	

Handling precautions:

- 1) These substances are at significant risk of ignition upon contact with air; thus, pay special attention to direct instructions received from a qualified individual.

- 2) Ruptured containers or earthquakes may lead to contact with air and spontaneous ignition; therefore, store these substances in suitable containers by observing appropriate storage methods. The solvents may become volatile and ignite, even after dilution; thus, these chemicals should be used with necessary caution.
- 3) Generally, as yellow phosphorus does not exhibit water-prohibitive properties, place it in glass bottles filled with water, and subsequently store it in a covered metallic container filled with sand. Other commercial organometallic and hydrides thereof are stored in iron containers under an inactive gas atmosphere. When these substances are segregated into flasks, always store them in metallic containers in a sealed metal storage cabinet; this strategy prevents fire by cutting off the oxygen supply.
- 4) Ensure that ignition does not occur when moving or washing the containers. Move or wash containers for yellow phosphorus under an inactive atmosphere of argon or nitrogen and containers for organic metals after dilution with inert solvents or alcohol treatment.
- 5) Because these substances are harmful even after treatment, follow the rules specified by the university.

Treatment:

- 1) It is best to burn incineration of yellow phosphorus each 40-50 g outdoors. Phosphorus pentoxide (P_2O_5) immediately transforms into phosphoric acid (H_3PO_4) and detoxifies. At this time, an iron plate or concrete structure should be utilized because phosphorous melt and burn. When phosphorous is burned on sand or earth, it turns into molten granules, which remain incombustible and should be handled by using rubber gloves and tweezers.
- 2) Organometallic compounds and hydrides, which emit harmless oxides after burning, are diluted with petroleum naphtha, kerosene, or decalin; these solvents possess high boiling points and do not ignite spontaneously. Subsequently, the substances are burned outdoors in small quantities.
- 3) For toxic oxides (As and Se), detoxify them in a laboratory and follow the rules and instructions specified by the university.

Likely occurrences:

- 1) When a Raney nickel catalyst is employed for hydrogenation, the liquid product is filtered out and subsequently rinsed with a solvent; thereafter, the filter paper is discarded safely because it may ignite after it has dried.
- 2) Organometallic compounds should always be handled as combustible substances; thus, proper care should be taken while cutting the container seals.

(3) Low-temperature pyrophoric substances

These substances oxidize at relatively low temperatures and burn; therefore, a risk of explosion from impact occurs when these substances come into contact with oxidants.

Table 5-8 Low-temperature pyrophoric substances

Compounds	Substance names	Law or regulation
	Red phosphorus, phosphorus sulfide (P_2S_3 and P_2S_5), and sulfur	Class 2 hazardous material.
Metal powder	Mg and Al powder, grains, and foil ribbon (including photographic flash powder), iron and zinc powder, tungsten and nickel fine powder, and non-Mg and Al powder	Same as above.

Handling precautions:

- 1) These substances oxidize readily and ignite when heated; therefore, store in a cool place away from heat sources or fire.
- 2) These substances ignite readily when mixed with oxidants and explode upon impact; hence, do not mix them oxidants inadvertently (sulfur is used in gunpowder and safety matches, and red phosphorus is used in safety matches).
- 3) Fine sulfur powder generally ignites in air and generates heat.
- 4) Metal powders burn severely when heated in air. In addition, hydrogen gas is generated along with acids and alkalis, which is at risk of igniting and fueling fire. Thus, special care should be taken in the presence of fire in the vicinity when reducing via iron or zinc powder.
- 5) Because phosphorus sulfide is a poisonous and toxic substance, necessary precautions should be taken while handling it.

(4) Water-prohibitive substances

In general, these substances (listed in Table 5-9) react readily with water to generate hydrogen or carbon, and the reaction may cause heat generation, ignition, or explosion.

Table 5-9 Water-prohibitive substance

Generic name	S u b s t a n c e s	Law or regulation
Metals and metal compounds	Na, K, Li, Ca, CaC_2 (carbides), Al_4C_3 (carbonization of aluminum), SiC, Ca_3P_2 (phosphorized coal), and CaO.	Class 3 hazardous material.
Hydrides	Metals hydrides of Li, Na, K, Cs, Ca, Ba, Zr, Cu, and Sn, $NaBH_4$, and $LiAlH_4$.	Class 3 hazardous material.
Alkali amides	$NaNH_2$ (sodiumamide) and KNH_2 (potassiumamide).	
Certain spontaneous combustible organic compounds	Organometallic compounds of Li, Na, K, Mg, Ca, Ba, Al, and Zn. For example, C_4H_9Li , $Al(C_2H_5)_3$, and $Zn(C_2H_5)_2$.	A few research field-specific substances, such as $Al(C_2H_5)_3$, are Class 3 hazardous materials.

Handling precautions:

- 1) These substances react violently with water and generate hydrogen or hydrogen carbide; hence, special precautions should be exercised in the presence of water. Do not inadvertently introduce tap water in the vicinity of water-prohibitive substances because any water spray may cause ignition or explosion.
- 2) Carefully handle metallic sodium when weighing. Quickly remove the surface oxide layer while wiping the storage solvent off the surface with filter paper before weighing. As metallic potassium rapidly reacts with water and atmospheric oxygen and ignites, place it in a wide-mouthed dish or beaker and remove the surface oxide layer with an inert solvent. Subsequently, place it in the pre-weighed inert solvent, and determine the weight from the difference between that before and after placement. Metallic lithium is safe to handle in air.
- 3) Place fragments of metallic lithium, sodium, or potassium into a flask in a water bath using tweezers; thereafter, remove the flask from the water bath without any inadvertent addition of the metal into the water, or cover the water surface with a board or iron plate.
- 4) Carbides react with water and occasionally explode. This phenomenon occurs owing to the high heat generated by the spontaneous ignition of the pure calcium phosphide contained in the raw material carbide.
- 5) Calcium phosphide reacts vigorously with water, occasionally resulting in explosions.
- 6) Raw lime does not ignite in the presence of water; nevertheless, other substances may ignite because of the heat generated.

Likely occurrences:

- 1) When shavings of metallic sodium stored in petroleum are placed in alcohol for an extended period and exhibit no further reactions, the petroleum may ignite when it is poured out for disposal; this ignition results from the small grains of sodium in the petroleum. Therefore, in the interest of environmental protection, never pour out any of the solvents.
- 2) During outdoor attempts to treat bottles containing shavings of metallic potassium stored in petroleum, the shavings may tumble out during transport and ignite; the outcome is more dangerous than that for sodium.
- 3) The inadvertent addition of water to white sodium, which has aged and the surface has oxidized or transformed into sodium carbonate, results in explosions. Always treat white sodium with alcohol.

2 Explosive substances

Explosions consist of explosive decomposition in which substances readily decompose under heat or impact and spontaneously undergo vaporization and expansion. Thermal explosions result from the ignition of flammable gas in air when the concentration crosses the explosion limit; this can occur in relation to the vapor pressure for low-boiling point liquid substances. Both may occur in experiments and

research.

(1) Gunpowder

Gunpowder (black gunpowder, smokeless gunpowder, mercury fulminate, lead azide, carlits, dynamite, and pyrotechnics) consists of molded products with a mixture of explosively decomposing substances; its usage is regulated by the Gunpowder Control Law and Fire Services Act, and its usage should be properly supervised.

(2) Explosively decomposing chemicals (Fire Services Act Class 5 hazardous materials)

These chemicals include nitric acid esters, nitro and nitroso compounds, nitroamines, organic peroxides, and other unstable and readily decomposable compounds.

Table 5-10 Explosively decomposing chemicals

Bond type	Name	Compound examples and Fire Services Act hazardous material class
N-O C-O-NO ₂	Nitric acid esters (A)	Nitroglycerine, nitroglycol, nitrocellulose (those gunpowder: Class 5 of hazardous materials designated under the Fire Defense Law), and monovalent alcohol ester (Class 4).
C-NO ₂	Nitrides (A)	Trinitrotoluene and picric acid, etc. (Class 5 and Class 4 according to the number of other attached nitro groups, respectively).
C-N-NO ₂	Nitroamines (A)	Trimethylene trinitroamine, cyclotetramethylene tetranitroamine (gunpowder) ethyl or phenylnitroamine (Class 5 according to the number of other attached nitro groups).
C-NO	Nitroso compounds (C)	C ₆ H ₅ NO, CH ₃ C ₆ H ₄ NO, and C ₁₀ H ₇ NO (Classes 5 and 4 according to the number of other attached nitro and nitroso groups).
M-ONC	Fulminates (B)	Hg(ONC) ₂ and AgNCO, which are used as triggers for other explosives.
N-N [Ar-N=N]+X	Diazonium salts (C)	C ₆ H ₅ N ₂ X and HOC ₆ H ₄ N ₂ X (normally handled below room temperature).
C-N ₂	Diazo compounds (A)	CH ₂ N ₂ (diazomethane; a toxic gas) liquid and concentrated solutions, which differ in safety outcomes depending on the type, such as N ₂ C (COOH) ₂ , N ₂ C (COOH ₂ H ₅) ₂ , N ₂ CHCO ₂ C ₂ H ₅ , and N ₂ CHCO ₂ C ₆ H ₅ . C ₆ H ₄ N ₂ O (diazophenol; explodes when dry) Diazonitrophenol (explodes when ignited by electricity or blasting cap).

MN ₃	Metal azides (B)	Heavy metal azides of Ag, Co, Pb, Hg, Cu, and Cd. Lead azide is used as a trigger for other explosives. Sodium azide was employed in early automobile air bags.
XN ₃	Halogen azides (B)	Explodes at temperatures below room temperature when X is F, Cl, Br, and I.
HN ₃	Hydrogen azides (B)	Unstable and explodes readily.
-CN ₃	Organic azides (B)	Stability differs depending on substances, such as CH ₃ N ₃ , N ₃ CH ₂ COOH, C ₆ H ₅ N ₃ , CH ₃ C ₆ H ₄ N ₃ , and C ₁₀ H ₇ N ₃ ; generally, decomposes when heated to room temperature or above (pay special attention to the decomposition point).
$\begin{array}{c} \text{O} \\ \\ \text{C}-\text{C}-\text{N}_3 \end{array}$	Organic acid azides (C)	Isocyanate raw materials such as CH ₃ CON ₃ and C ₆ H ₅ CON ₃ (Curtius rearrangement).
MC≡CM	Acetylides (A)	Heavy metal acetylides are unstable (such as silver and copper acetylide)
$\begin{array}{c} \text{O}-\text{O} \\ \\ \text{H}-\text{O}-\text{O}-\text{R} \end{array}$	Hydroperoxides (B)	Refer to Section 2, 1. (1) Oxidants. Isobutylhydroperoxide and cumene hydroperoxide.
R-O-O-R	Dialkylperoxides (C)	(Di)ethyl peroxide, (di)isobutyl peroxide, methyl ethyl ketone peroxide, and cyclohexanone peroxide.
RCO-O-O-H	Peroxyacids (C)	Peracetic acid, perpropionic acid, and perbenzoic acid.
RCO-O-OR	Peroxyacid esters (C)	Peracetic acid t-butyl, persebacic acid t-butyl, and perbenzoic acid t-butyl esters.
$\begin{array}{c} \text{RCO}-\text{O}-\text{O}- \\ \text{OCR} \end{array}$	Diacylperoxides (C)	Acetyl peroxide, propionyl peroxide, and benzoyl peroxide.
$\begin{array}{c} \text{O}-\text{O} \\ / \quad \backslash \\ \text{C} \quad \quad \text{C} \\ \backslash \quad / \\ \text{O} \end{array}$	Ozonides (B)	Oily substances that promptly decompose in reaction to ozone and unsaturated compounds.

NOTE: The following letters indicate the severity of hazardousness in the table:

A= Very hazardous; B= Somewhat hazardous; C = Hazardous.

Handling precautions:

- 1) When synthesizing the above-mentioned substances or similar substances, or using them as raw materials or polymerization inhibitors, experiments should be conducted after carefully examining

their properties. In addition, proper care should be exercised when byproducts as well as reaction liquid waste is likely, which should be treated as promptly as possible.

- 2) The above-mentioned substances frequently explode when they are heated or upon contact with acids, alkalis, metals, or reducing substances. Therefore, caution should be exercised, and the proper containers or spatulas should be utilized.
- 3) Explosions may result in the ignition of flammable substances in the vicinity and cause fire; thus, clean the surrounding area and prepare firefighting equipment accordingly.
- 4) Because the above-mentioned substances are highly toxic, protection strategies should be adopted.

Likely occurrences: (oxidants 2–4)

- 1) During the recovery of silver chloride (precipitate of ammonia solution) that has been left standing for an extended period, the dried filtrate is at risk of explosion owing to generation of silver azide.
- 2) An explosion may occur during the synthesis of azide acrylate using chloride acrylate and sodium azide (NaN_3). After the removal of chlorine compounds from vinyl isocyanate following the Curtius rearrangement (similar boiling points of acid chloride and isocyanate), silver precipitate is added for distillation.
- 3) When the products of nitration reaction are distilled, an explosion may occur for a small amount of residual liquid, which is explosive in nature owing to high nitro compound content of the byproduct.
- 4) If a mixture of ethylene and alcohol with dilute nitric acid is left standing for a considerable period, the mixture may ignite (the water and alcohol will evaporate and esterize).
- 5) If the catalyst (metal acetylide) used in alkanol synthesis reaction via Reppe reaction is left standing, it will dry out and explode upon slight impact (i.e., it remains stable in damp conditions).

(3) Flammable gas

Hydrogen, carbon monoxide (CO), ammonia gas (NH_3), hydrogen sulfide (H_2S), city gas, and household LPG (mixture of C_3 and C_4 hydrocarbons and hydrogen carbide).

Hydrogen carbides:	Methane (CH_4), ethane (C_2H_6), propane (C_3H_8), butane (C_4H_{10}), ethene (ethylene; C_2H_4), propylene (C_3H_6), butene (C_4H_8), acetylene (C_2H_2), cyclopropane (C_3H_6), and butadiene (C_4H_6)
Amines:	Methylamine (CH_3NH_2), dimethylamine ($(\text{CH}_3)_2\text{NH}$), trimethylamine ($(\text{CH}_3)_3\text{N}$), and ethylamine ($\text{C}_2\text{H}_5\text{NH}_2$)
Alkyl halides:	Methyl chloride (CH_3Cl), ethyl chloride ($\text{C}_2\text{H}_5\text{Cl}$), vinyl chloride ($\text{C}_2\text{H}_3\text{Cl}$), and methyl bromide (CH_3Br)

Handling precautions:

- 1) Leakage from equipment will accumulate, ignite, and explode when the concentrations cross the explosion limit. Take necessary precautions when using flammable gas cylinders and conducting experiments that generate flammable gas.
- 2) Strictly observe warnings on the handling of cylinders (refer to warning for high-pressure gas and liquefied gas in Chapter 4, Section 4) and regularly inspect the municipal piped-gas cocks.
- 3) Properly address any noticeable gas leaks in cylinder gaskets, pipes, or leaks in municipal gas lines. That is, wear face shields and gas masks as required when conducting experiments that are at risk of explosion or toxic gas generation. In case of a massive gas leak, turn off any flame or gas sources, open the windows for ventilation, and temporarily evacuate the structure. In case of rapid gas leaks (e.g., the safety valve on cylinder of hydrogen or other flammable gas has been blown off), immediately evacuate the building and assess the situation.
- 4) Because acetylene and ethylene oxide decompose explosively, do not heat or allow any impact on these substances in direct sunlight or within the vicinity of a heat source.

Likely occurrences:

- 1) Acetylene cylinders will explode if dropped during transport; all cylinders should be fitted with a safety cap during transport.
- 2) Generally, the mixed gas reaches its explosion limit in oxidation reactions and explodes owing to the rapid heat generation by the reaction; thus, protective walls or screens should be installed.

3 Flammable substances

Combustibles are dangerous substances because they have vaguely described ignition points; the lower the ignition point, the greater is the hazard. The ignition point refers to the lowest temperature at which a liquid becomes a flammable concentrated vapor when its top layer mixes with air. Nevertheless, substances with a high ignition point are also dangerous when heated to temperatures above the ignition point; several accidents have been experienced in laboratories owing to such conditions.

When using flammable substances, ensure that the rooms are well-ventilated and exercise precautions concerning the exhaust. For example, considering that vapor is heavier than air, ventilation holes should be added at the floor level.

Table 5-11 Flammable substance classification

Classification		Definition	Fire Services Act class
Special flammable substances		Liquid at 20 °C or 20–40 °C with ignition temperature* 100 °C or less, ignition point -2 0°C or less, and boiling point 40 °C or less.	Special flammable substances.
Regular flammable substances	High flammability substances	Highly flammable at room temperature; ignition point of 20 °C or less (Fire Services Act Class 1 petroleum and Class 4 compounds exhibiting similar flammability).	Class 1 Petroleum and equivalent flammable substances.
	Moderate flammability substances	Highly flammable; ignition point of 21–70 °C (Fire Services Act Class 2 petroleum and Class 4 compounds with the same flammability).	Class 2 petroleum and equivalent flammable substances.
	Low flammability substances	Ignites when decomposition gases are strongly heated; general ignition point of 70 °C or higher, 70–200 °C for Class 3 petroleum, and 200 °C or higher for Class 4 petroleum. Includes Fire Services Act Class 4 compounds with similar flammability.	Classes 3 and 4 petroleum, animal, and vegetable oils.

NOTE) *Known as the flash point; refers to the lowest temperature at which combustibles spontaneously ignite when heated in the air.

When storing flammable substances, sealed containers are critical for the prevention of gas or vapor leakage and protection from fire or sunlight.

Flammable substances are classified into four types on the basis of the definitions in Table 5-11, and any substance that is not a special flammable substance is referred to as a regular flammable substance.

(1) Special flammable substances

Diethyl ether, carbon disulfide, acetaldehyde, pentane, isopentane, propylene oxide, divinylether, and nickel carbonyl.

Handling precautions:

- 1) As these substances possess low ignition points and ignite with relative ease, extinguish any flames and turn off electric heaters and stoves in the vicinity of these substances.
- 2) Considering that these substances exhibit low boiling points and a wide explosion limit, ensure appropriate ventilation and prevent any accumulation of these substances.
- 3) Upon ignition, these substances spread explosively and are difficult to extinguish. Therefore, these substances should be stored away from other flammable substances.
- 4) Wear gas mask and rubber gloves when handling toxic and irritating substances and handle under proper ventilation.

Likely occurrences:

- 1) Special flammable substances have low ignition points; thus, they will ignite during handling if there is flame in the vicinity.
- 2) Ether readily transforms into peroxides and explodes if no residual liquid is formed after distillation.
- 3) When a flask filled with ether solution is placed in a refrigerator, the ether vapor generally leaks (the stored flasks often break); this vapor is ignited by the refrigerator switches and subsequently explodes; thus, utilize explosion-proof refrigerators.

(2) Regular flammable substances

a. Highly flammable substances (ignition point: 20 °C or less)

Hydrogen carbides: Hydrogen carbides possessing a carbon number of up to 8, such as petroleum ether, gasoline, petroleum benzine, ligroin, dimethylbutane, hexene, heptane, cyclopentane, methylcyclopentane, cyclohexane, cyclohexene, octane, benzene, toluene, and ethyl benzene (except special flammable substances).

Esters: Formic acid esters (up to butyl groups), acetate esters (up to propyl and including vinyl groups), methyl and ethyl propionate, methyl and ethyl acrylate and methacrylate, amyl nitrite, carbonic acid methyl, and boric acid methyl.

Alcohols: Up to propyl groups.

Ethers: Propylether, methylal, dioxane, furan, methylfuran, and tetrahydrofuran.

Aldehydes: Propionaldehyde, acrolein, crotonaldehyde, butylaldehyde, and paraaldehyde.

Ketones: Acetone, methyl ethyl ketone, methylvinylketone, and methylpropylketone.

Amines: Diethyl amine, triethylamine, propylamine, arylamine, butylamine, amylamine, pyridine, piperidine, and methylmorpholine.

Halides: Aryl chloride, aryl bromide, butyl chloride, butyl bromide, amyl chloride, vinylidene chloride, dichloroethane, chloropropane, dichloropropane, and chloro benzene.

Acid chlorides: Acetyl chloride and propionyl chloride.

Mercaptans: Ethylmercaptan, butylmercaptan, thiophene, and tetrahydrothiophene.

b. Moderately flammable substances (ignition point: 21–70 °C)

Hydrocarbons:	Kerosene, light oil, turpentine oil, cumene, cymene, decane, dicyclopentadiene, dipentene, styrene, methylstyrene, propyl benzene, and diethyl benzene.
Esters:	Butyl acetate, amyl acetate, butyl propionate, ethyl crotonate, ethyl acetate, methyl chloroacetate, ethyl bromoacetate, methyl lactate, ethyl lactate, and diethyl carbonate.
Alcohols:	Butanol, amyl alcohol, hexyl alcohol, methacryl alcohol, cyclohexanol, cellosolve, and diacetone alcohol.
Ethers:	Butylether, amylether, and anisole.
Aldehydes:	Furfural and benzaldehyde.
Ketones:	Methylbutylketone, methylamylketone, diethyl ketone, and dipropylketone.
Amines:	Hexylamine, cyclohexylamine, tripropylamine, ethylenediamine, propylenediamine, diethyl ethylenediamine, picoline, methylpicoline, and hydrazone.
Halides:	chlorobenzene, bromobenzene, chlorophenol, epichlorohydrin, ethylenechlorohydrin, and propylenechlorohydrin.
Nitrides:	Nitroethane, nitromethane, and nitropropane.

c. Low flammability substances (ignition point: 70 °C and above)

Hydrocarbons:	Lubricants, such as fuel oil, creosote oil, spindle oil, gear oil, and motor oil; high-grade liquid hydrogen carbide, such as transformer oil and tetralin.
Esters:	Octyl acetate, phenyl acetate, methyl and ethyl benzoate, ethyl oxalate, ethyl maleate, butyl phthalate, and octyl phthalate.
Alcohols:	Octanol, benzyl alcohol, aldol, furfuryl alcohol, tetrahydrofurfuryl alcohol, ethyleneglycol, diethyleneglycol, propyleneglycol, glycerine, and ethylene cyanohydrin.
Ethers:	Diethylene glycol dimethyl and ethyl ether.
Amines:	Tributylamine, ethanolamine, aniline, <i>N</i> -mono and disubstituted aniline, toluidine, and phenylhydrazine.
Chlorides:	Benzyl chloride.
Carbonic acids:	Acetate and anhydrous propionic acid.
Acid chlorides:	Benzoyl chloride.
Nitrides:	Liquid monosubstitution of nitrobenzene and nitroxylenes.

Other: γ -butyrolactone, styrene oxide and dimethylsulfoxide.

Animal and vegetable oils: Soybean oil, sesame oil, coconut oil, sardine oil, flaxseed oil, and whale oil.

Handling precautions:

- 1) High flammability substances are not as flammable as special flammable substances; nevertheless, these substances are still highly flammable and are easily ignited by sparks from switches or static electricity as well as red-hot materials, such as electric heaters or burning cigarettes. Thus, fire in the vicinity should be avoided, and these substances should never be heated with a direct flame.
- 2) Acetone, petroleum ether, hexane, benzene, methanol, ethanol, ethyl acetate, and tetrahydrofuran are often used as solvents. As these chemicals possess a high vapor pressure and are highly flammable, they should be handled with necessary caution.
- 3) High flammability substances have considerably high vapor pressure and vapor density and consequently accumulate with great ease; hence, appropriate ventilation should be maintained.
- 4) Moderately flammable substances are easily ignited when heated; therefore, appropriate care should be ensured to contain the vapor when heated in open containers.

Likely occurrences:

- 1) These substances boil explosively and ignite owing to heating and the inadvertent addition of zeolite during distillation; this is a frequent occurrence in laboratories, and the zeolite should be added after refrigeration.
- 2) When flasks are rinsed with acetone and then placed in a dryer for drying, acetone in the flask will vaporize and may explode.

(3) Organic solvents

Organic solvents are frequently used in laboratories in large quantities. Because these substances can be either special flammable substances or high flammability substances, their management and storage is governed by the Fire Services Act and fire prevention ordinances. In addition, necessary precautions should be exercised while handling these substances to prevent organic solvent poisoning and maintain hygienic conditions.

Handling precautions:

- 1) The substance amounts that can be stored at each laboratory are governed by the Fire Services Act and fire prevention ordinances; therefore, the minimum amounts needed are stored within laboratories. When purchased in petroleum barrels, these substances should always be stored in a hazardous material warehouse, and the required amounts should be transported to laboratories only when these substances are needed.

- 2) Special flammable substances and high flammability substances, which exhibit high evaporation points and low ignition points, are handled by strict observing the relevant warnings concerning potential accidents.
- 3) As these substances are critically tied to the biological and chemical oxygen demand in water bodies, which are matters of concern for the local regulation of water and prevention of its pollution, the liquid waste should be treated in accordance with the rules and instructions specified by the university.
- 4) In terms of hygiene, although acute toxicity is not necessarily strong enough to create a negative impact in terms of hygiene, in terms of chronic toxicity, these substances should be handled carefully (refer to Section 4, 1.5).

4 Acids

These substances consist of inorganic strong acids (sulfuric acid, hydrochloric acid, nitric acid, and hydrofluoric acid), organic strong acids (trichloroacetic acid, trifluoroacetic acid, sulfonic acid, and picric acid), and weak acids (phosphoric acid, boric acid, and organic carboxylic acid).

Fuming nitric acid (concentrated nitric acid containing NO_2): Exhibits considerably strong oxidizability and ignites and oxidizes phosphine (PH_3), hydrogen sulfide (H_2S), and hydrogen iodide (HI).

An oxidant and nitrating agent. The nitrogen dioxide (NO_2) gas generated is extremely toxic.

Fuming sulfuric acid ($\text{SO}_3\text{-H}_2\text{SO}_4$): Reacts violently with water to yield sulfuric acid (accompanied by significant heat generation). Acts as a strong oxidant, sulfonating agent, and skin irritant.

Chlorosulfonic acid (HSO_3Cl): A sulfonating agent, which reacts violently with water to generate sulfuric acid and hydrochloric acid and irritates the skin.

Anhydrous sulfuric acid (sulfur trioxide; SO_3): Reacts violently with water to yield sulfuric acid (accompanied by significant heat generation). Acts as a strong oxidant, sulfonating agent, and skin irritant.

Concentrated nitric acid (commercially available; HNO_3 content of 62–70%): Exhibits strong oxidizability. Used to manufacture nitric acid salts and as a nitrating agent. Harms the trachea when inhaled, resulting in pneumonia-like symptoms. Additionally, this substance harms the skin mucous membrane.

Concentrated sulfuric acid (H_2SO_4): Exhibits an extremely high heat of dilution; when water is added to concentrated sulfuric acid, it generates heat and explodes. In addition, it reacts with charcoal to produce CO_2 , acts as a dehydrating agent, and exhibits oxidation action at high temperatures. It is used to manufacture sulfuric acid salts and sulfonic acid and harms the skin.

Anhydrous chromic acid (chromium trioxide: CrO_3): Dissolves in water to yield chromic acid. A Strong oxidant, which exhibits severe toxicity and irritates the kidneys.

Perchlorate (HClO_4): A fuming liquid (anhydride). It is unstable and decomposes when left to stand; explodes when heated. Exhibits strong oxidizability. In addition to monohydrate, dihydrate and trihydrate forms exist, but the commercially available product is a 60% or 70% aqueous solution.

Thionyl chloride (SOCl_2): Reacts with water to produce sulfurous acid gas (sulfur dioxide; SO_2) and hydrogen chloride (HCl). It is used in the manufacture of acid chloride from carboxylic acid and sulfonic acid.

Sulfuryl chloride (SO_2Cl_2): Decomposes into sulfuric acid and hydrochloric acid after reacting with water.

Handling precautions:

- 1) When the above-mentioned substances are mixed with the chemicals specified in the Fire Services Act hazardous material Classes 1–5 chemicals, these acids oxidize, dehydrate, and react, and the reaction generates heat, ignition, explosions, product decomposition, and explosions, thus igniting and exploding the generated gas.
- 2) Use special fire retardants and not water to extinguish fire in places where the above-mentioned acids are stored.
- 3) Accidents in laboratories and research centers involving the above-mentioned acids often result in chemical burns to the skin, mouth, and eyes. These are described in detail along with the relevant measures in Section 3 concerning acids and alkalis.

5 Mixed hazardous materials

In general, when two or more substances are mixed together, rapid boiling, scattering, ignition, or explosions may occur owing to the heat generated by the heat of mixing or chemical reaction from diffusion or dissolution. These substances are referred to as mixed hazardous materials. Physical examples include the addition of water to concentrated sulfuric acid, addition of small amounts of water to large amounts of solid caustic soda, and mixing of high-temperature liquids and low-boiling point substances. When classifying On the basis of cause of ignition or explosion, these materials are classified into ① those materials that burn or explode when heat is generated via rapid decomposition or reactions, ② those materials that generate explosive compounds, and ③ those materials that decompose and explode when mixed with air or oxygen. The combination examples listed in Table 5-12 represent mixed hazardous materials. Table 5-13 presents the mixing risks according to the Fire Services Act. Table 5-13 should be referenced for the storage or transportation of chemicals, liquid waste collection from the laboratory, or solid waste accumulation.

Table 5-12 Chemical combinations with explosion hazard when mixed (A+B)

Chemicals A	Chemicals B	Chemicals A	Chemicals B
Alkali metals, powdered aluminum, or magnesium.	Carbon tetrachloride, carbon disulfide, and halogen (reaction).	Iodine (violent heat generation and product decomposition).	Acetylene, ammonia (in solution or anhydrous form), and hydrogen.
Potassium, sodium (reaction).	Carbon tetrachloride, carbon dioxide, and water.	Fluorine (same as above, especially large heat generation owing to large binding energy).	Significantly high reactivity to all compounds.
Copper (acetylide generation and decomposition reaction).	Acetylene and hydrogen peroxide.		
Silver (acetylide generation and decomposition reaction and silver fulminate and silver azide generation).	Acetylene, oxalic acid, tartaric acid, fulminic acid, and ammonium compounds.	Hydrogen peroxide (rapid decomposition reaction).	Copper, chrome, iron, or salts thereof, alcohol, acetone, organic substances, aniline, flammable material, flammable liquid, and nitromethane.
Mercury (acetylide, fulminic acid mercury and azide generation).	Acetylene, fulminic acid, and ammonia.	Ammonia (anhydrous) (mercury and silver generation, violent heat generation reaction, and product decomposition).	Mercury (e.g., monometer mercury) chlorine, calcium hypochlorite, iodine, bromine, anhydrous hydrofluoric acid, and silver compounds.
Chlorine (violent heat generation reaction and product decomposition).	Ammonia, acetylene, butadiene, butane, methane, propane (other petroleum gas), hydrogen, sodium, carbide, turpentine oil, benzene, and finely powdered metals.	Chromic acid (oxidation reaction and oxygen generation).	Acetate, naphthalene, camphor, glycerine, turpentine oil, alcohols, and common oxidizers.
		Potassium permanganate (rapid oxidation reaction).	Ethanol or methanol, glacial acetic acid, anhydrous acetate, benzaldehyde, carbon disulfide, glycerine, ethylene, glycol, ethyl acetate, methyl acetate, and furfural.
Anhydrous hydrofluoric acid (violent heat generation reaction)	Ammonia (water-containing or anhydrous form).		

Nitric acid (concentrated) (oxidation reaction, heat generation)	Acetate, aniline, chromic acid, cyanide acid, hydrogen sulfide, flammable liquid, flammable gas		
Sulfuric acid (free of chloric acid; permanganic acid generation and decomposition and oxidation reaction thereof).	Potassium chlorate, potassium perchlorate, potassium permanganate, or permanganic acid salts of light metals such as sodium, potassium, or lithium.	Hydrogen carbides such as butane, propane, benzene, gasoline, and turpentine oil.	Fluorine, bromine, chromic acid, and sodium peroxide (violent heat generation reaction, oxidation reaction and peroxide generation).
		Acetylene (violent heat generation reaction, product decomposition and acetylide generation)	Chlorine, bromine, copper, fluorine, silver, mercury.
Chlorine dioxide (violent heat generation reaction and product decomposition).	Ammonia, methane, phosphine, and hydrogen sulfide.	Aniline (oxidation reaction).	Nitric acid and hydrogen peroxide.
Chlorates (explosives mixed in gunpowder or its high-explosive equivalent)	Ammonium salts, acids, metal powder, sulfur, finely powdered general organic substances, or flammable substances.	Oxalic acid (rapid decomposition).	Silver and mercury.
		Cumene hydroperoxide (rapid decomposition).	Oxygen (organic or inorganic).
Potassium permanganate (rapid oxidation reaction).	Anhydrous acetate, bismuth and alloys thereof, alcohol, paper, and wood.	Flammable liquid (oxidation reaction, peroxide generation, and rapid reaction).	Ammonium nitrate, hydrogen peroxide, nitric acid, sodium peroxide, and halogen.

NOTE: () in table indicates cause.

Table 5-13 Mixing risks according to the Fire Services Act

	I	II	III	IV	V	VI
Class 1 Hazardous materials (I oxidizing solid)		×	×	×	×	○ ^b
Class 2 Hazardous materials (II flammable solid)	×		×	○	○ ^a	×
Class 3 Hazardous materials (III spontaneous combustible • water-prohibitive substance)	×	×		○ ^b	×	×
Class 4 Hazardous materials (IV flammable liquid)	×	○	○ ^b		○ ^b	×
Class 5 Hazardous materials (V self-reactive substances)	×	○	×	○ ^b		×
Class 6 Hazardous materials (VI liquid oxide)	○ ^b	×	×	×	×	

NOTE: × is mixing prohibited. ○ is mixable.

○ is mixable, but

a: Mixing risk should be considered.

b: Mixing risk should be considered depending on the situation.

Mixture precautions:

- 1) Do not inadvertently mix inorganic and organic compounds. In addition, when mixing, always be careful with chemical combinations that represent explosion hazards.
- 2) Spontaneous pyrophoric substances, oxidizers, and water-prohibitive substances should never be inadvertently mixed with other substances.
- 3) When Fire Services Act Class 6 strong acids are mixed together with Classes 1, 2, 3, and 5 chemicals, extreme caution should be exercised owing to the heat of neutralization and generation of hydrogen halides.
- 4) Phosphorus trichloride (PCl₃), phosphorus pentachloride (PCl₅), thionyl chloride (SOCl₂), titanium chloride (IV) (TiCl₄), silicon tetrachloride (SiCl₄), and acid chloride (RCOCl) (similar outcomes with Br and I as that of Cl), which are not classified as water-prohibitive substances under the Fire Services Act, react violently with water, alcohol, and amines and generate hydrogen halides; therefore, necessary caution should be taken when handling these substances.
- 5) Fire Services Act Class 4 compounds include liquid compounds that exhibit various properties (e.g., amines, carboxylic acid, and acid chloride), and thus require careful handling; only those substances that do not react or neutralize should be mixed.
- 6) The risks associated with mixing these compounds are significant and require attention; as the reactions are not always fast, fire or explosions may occur even when the liquid laboratory waste is stored separately, during its transit to a temporary storage facility, or during storage. In addition, these compounds may cause fire or explosion in solid waste storage locations. Precautions should be taken for the collection, storage, and preservation of waste and liquids used in experiments.

Section 3 Acids and alkalis

Acids and alkalis are typically used in laboratories. These chemicals range widely from inorganic and organic strong acids and strong alkalis to weak acids and weak alkalis. The chemical types that tend to result in accidents have been described in this section.

1 Acids

Sulfuric, hydrochloric, nitric, and hydrofluoric acids are inorganic strong acids, whereas trichloroacetic, trifluoroacetic, sulfonic, and picric acids are organic strong acids. Additionally, phosphoric, boric, and carbonic acids are inorganic weak acids, and various organic carboxylic acids are organic weak acids.

The acids with a high risk of associated accidents in laboratories are inorganic acids, such as sulfuric, hydrochloric, and nitric acids with a high concentration and hydrofluoric acids, which exhibit special action. Handling precautions:

- 1) Sulfuric acid (fuming sulfuric and concentrated sulfuric acids, hereinafter referred to as sulfuric acid), nitric acid (fuming nitric and concentrated nitric acids, hereinafter referred to as nitric acid), and concentrated hydrochloric acid are strongly acidic mineral acids, which may cause chemical burns or vision loss upon contact with the skin or eyes. In addition, contact with an explosively decomposing substance may result in an explosion or ignition.
- 2) Sulfuric, hydrochloric, nitric, hydrofluoric, chlorosulfuric, trichloroacetic, and trifluoroacetic acids are highly corrosive substances and should be immediately rinsed off upon contact with the skin. Hydrofluoric acid is particularly dangerous in this regard; thus, rubber gloves should be worn when handling this acid.
- 3) As nitric, hydrochloric, anhydrous, and fuming sulfuric, and hydrofluoric acids release toxic gas, proper care should be exercised to avoid inhalation or contact with the skin. Because hydrofluoric acid, in particular, can cause respiratory disorders or injure the eyes, a gas mask should be worn when handling this acid.
- 4) Nitric acid oxidizes and sulfuric acid dehydrates; these acids generate a large amount of heat during their respective processes, thus generating heat or undergoing ignition when mixed with organic substances.
- 5) Sulfuric acid generates considerable heat upon dilution, and other acids also exhibit a large heat of neutralization when neutralized with concentrated alkali. Refer to the section concerning the handling of sulfuric acid. For the other acids, neutralize the individual dilute solutions, and add other concentrated solutions to dilute the solution in small amounts while mixing thoroughly.

(1) Sulfuric acid (H₂SO₄, including anhydrous sulfuric and fuming sulfuric acids)

a. Hazards

Sulfuric acid does not self-explode or self-ignite; nevertheless, note the properties described in the

segment labeled "Handling precautions" in entries 1), 2), and 5).

b. Corrosive and physiological effects

Sulfuric acid reacts with various metals, often generates hydrogen gas, and dehydrates organic substances; occasionally, the generated heat may result in ignition. Biocorrosion reactions to concentrated sulfuric acid and hot sulfuric acid include severe tissue damage, chemical burns, and vision loss upon contact with the eyes. Inhalation of large quantities of the vapor from heated sulfuric acid or fuming sulfuric acid causes damage to lung tissue.

c. Precautions for use

- 1) May ignite or explode when in contact or mixed with oxidants, explosively decomposing substances, metal powders, or organic substances; thus, handle this acid at a safe distance from these triggering substances.
- 2) As sulphuric acid may cause chemical burns, avoid contact with any part of the body.
- 3) Sulphuric acid possesses a large specific gravity. Thus, when this acid is placed in a large glass beaker, the beaker may break if it is held from the top or edges and should be supported from the bottom with both hands to avoid breakage.
- 4) When diluting anhydrous sulfuric acid (SO_3) or fuming sulfuric acid, utilize sulfuric acid that is as concentrated as possible.
- 5) Rinse out empty bottles after use and store them in a designated place.

d. Measures for spillage

Sulphuric acid corrodes concrete floors and metals and carbonizes organic substances. Any spilled acid that is flowing should be rinsed and diluted with large quantities of water. Subsequently, wipe off the diluted acid while wearing rubber gloves. Alternatively, dilute the acid with water, neutralize it with baking soda or lime, and subsequently wipe it off the surface.

- e. When concentrated sulfuric acid clings to clothes, immediately rinse with large quantities of water, neutralize the acid with diluted ammonia water or 1–2% baking soda (or sodium carbonate), and thoroughly rinse with water. As dilute sulfuric acid will concentrate over time and damage the fabric, wash the clothes with neutralizing water.

Likely occurrences:

- 1) Inhalation of dilute sulfuric acid into the mouth may occur with relative ease when drawing from a pipette.
- 2) During the preparation of dilute sulfuric acid, the addition of water to concentrated sulfuric acid may generate heat and cause the acid to splash into the eyes. Moreover, rapid heating will break the beaker, resulting in the spillage of sulfuric acid.
- 3) During measurements for the melting point of an organic substance, the measuring tube containing hot concentrated sulfuric acid may break, and the resultant spill may burn the hands or face.
- 4) If rags soaked in concentrated sulfuric acid are disposed of with rags soaked in waste oil, ignition of this acid may occur.

(2) Hydrochloric acid (HCl, commercial concentrations ranging from 35% to 38%)

a. Hazards

Hydrochloric acid presents minimal hazard; nevertheless, note the properties listed in the segment labeled “Handling precautions” in entries 2) and 3). In other words, hydrochloric acid reacts with various metals and generates hydrogen.

b. Corrosive and physiological effects

Hydrochloric acid is damaging to most metals, but not to plastics. Compared to sulfuric acid, contact with the skin and mucous membranes causes less inflammation. The greater risk is posed by the inhalation of HCl gas or mist generated by hydrochloric acid. For hydrochloric acid gas, the tolerance concentration is 5 ppm.

c. Precautions for use

Because the internal pressure of capped bottles is considerably high, resulting in the contents to spray outward, these bottles should be opened with the bottle opening facing away from users and at a safe distance from their faces. Note that hydrochloric acid is highly corrosive, and hydrogen chloride gas and mist are toxic.

d. Measures for leakage

Although their chemical reactivities differ moderately, the measures involved are identical to those for sulfuric acid.

e. When it clings to clothes

Observe the measures stated for sulfuric acid.

Likely occurrences:

When a new bottle of hydrochloric acid is opened during summer, gas may spray out forcefully owing to the high internal pressure and cover the body.

(3) Nitric acid (HNO₃, including fuming nitric acid)

a. Hazards

Nitric acid alone is not explosive and does not burn or spontaneously ignite; however, unlike sulfuric or hydrochloric acid, it is an oxidizing acid. In addition to the properties listed in “Handling precautions” in entries 1), 2), 3), and 4), its oxidation reaction to hydrogen sulfide, carbon disulfide, acetylene, hydrazines, or amines is violent and may ignite or explode if mixed. In addition, contact with many organic substances, including alcohols, glycols, glycerines, oxygen or sulfur-containing compounds, wood fragments, paper, paper scraps, or rags generates ester bonds or unstable compounds and may result in explosion or spontaneous ignition. In addition, nitric acid reacts with most metals.

b. Corrosive and physiological effects

Nitric acid is corrosive and exhibits oxidation action. It irritates the skin and mucous membranes upon contact, leaving chemical burns of yellowish-brown color, and it may cause damage or vision

loss upon contact with the eyes. Owing to its high acidity, oral consumption will result in corrosion of the stomach tissue. Concentrated nitric and fuming nitric acids generate nitrogen oxide gas and damage the respiratory organs upon inhalation. The tolerable concentration for nitric acid is 10 ppm.

c. Nitrogen oxide gas damage

Nitrogen dioxide (NO_2 ; reddish-brown color) and dinitrogen trioxide (N_2O_3 ; dark blue color) are highly toxic compounds. Upon inhalation of 5 ppm of gas for 8 h, symptoms of pulmonary edema will inevitably appear within the following 5–48 h. Concentrations of 500–1000 ppm will have fatal consequences if the gas is inhaled all at once within a short time.

d. Precautions for use

Nitric acid is a Fire Services Act Class 6 hazardous material. It generates toxic NO_x gas and exhibits oxidizing properties; therefore, entries 1), 2), and 5) in the precautions listed for the usage of sulfuric acid and those for the usage of hydrochloric acid should be considered.

e. Measures for spillage

Although the chemical reactivity of nitric acid differs moderately from that of sulfuric and hydrochloric acid, measures involved for spillage of nitric acid are similar to those for these other acids; hence, the initial dilution of the acid with water is essential. In particular, nitrogen oxide is harmful and should never be inhaled. Upon immediate neutralization with soda ash or lime, a large quantity of nitrogen oxide gas is generated owing to the heat of neutralization.

f. When it clings to clothes

In a manner similar to that for the removal of sulfuric and hydrochloric acids clinging to clothes, immediately rinse with large quantities of water, and neutralize with 2% sodium carbonate water (or sodium carbonate water solution) or lime. After neutralization, thoroughly rinse further with water. Cotton and rayons, in particular, will generate nitrocellulose upon contact with concentrated nitric acid and thus are at risk of burning. Therefore, these fabrics should not be left untreated.

g. Hygiene precautions

Sites wherein nitrogen oxide gas is generated should be well ventilated. If any gas is generated, immediately vacate the room, and do not enter until the gas has fully dissipated.

Likely occurrences:

Inadvertent spillage of concentrated nitric acid will result in yellowing of the skin followed by burning.

(4) Hydrofluoric acid (HF, regular commercial concentration ranging from 40% to 50%)

Precautions: Because certain glass marking, patterning, matting, and metal surface treatment agents contain hydrofluoric acid, the presence of hydrogen fluoride in these agents should be determined before handling them.

a. Hazards and toxicity

Hydrofluoric acid can dissolve most metals except for gold and platinum (lead is used for

containers or linings because fluorides are poorly soluble in water). It corrodes silicates such as silicon dioxide, pottery, porcelain, and glass and produces volatile silicon tetrafluoride.

b. Corrosive and physiological effects

Hydrofluoric acid is employed for etching metals, silicate, enamel, and galvanized iron. Owing to its powerful action, contact with this acid will result in harsh effects on the human body. Contact with the skin causes harsh irritation and chemical burn as well as tissue penetration of tissue, the effects of which are much worse compared to the other acids. The tolerable concentration for hydrofluoric acid is 3 ppm. Upon contact with the eyes, it causes intense pain in the eyes and eyelids, resulting in long-term or permanently impaired vision or complete loss of vision. When it enters the respiratory organs, this acid causes harsh inflammation or hyperemia in the airway or lungs, which in serious cases leads to death. Upon ingestion, this acid causes gangrene in the esophagus and stomach, vomiting, diarrhea, and disruption of the circulatory system, ultimately leading to death.

c. Protection and prevention

Hydrofluoric acid is highly toxic and has a harsh corrosive effect on living bodies. Consequently, rubber gloves should always be used when handling this acid, and the use of protective masks is also recommended. In addition, to avoid any contact with its vapor mist, handle this acid under appropriate ventilation. Alkaline rinsing of the exhaust gas should be performed, and the hydrogen fluoride gas should never be directly released into the atmosphere. In addition, because the contact of this acid with silicate generates strongly toxic hydrogen silicofluoride gas, necessary caution should be exercised while analyzing the glass etching and silicate.

d. Measure for spillage

Hydrofluoric acid is toxic, and its physiological effects are severe. Thus, complete precautions should be taken when a spillage occurs on the floor or in other areas. Dilute the spilled acid with water, and add carbonic acid soda or a solution thereof in small drops to neutralize it into sodium fluoride (NaF), which does not exhibit corrosive action. Furthermore, as hydrofluoric acid reacts with glass and similar substances to generate hydrogen silicofluoride gas, so precautions should be taken.

e. When it clings to clothes

Immediately remove the clothes, and rinse them with large quantities of water. Thereafter, neutralize them with 2% sodium bicarbonate (sodium bicarbonate aqueous solution); after neutralization, thoroughly rinse further with water.

2 Alkalis

Strong alkaline sodium hydroxide (caustic soda), potassium hydroxide (caustic potash), and weak alkaline aqueous ammonia are frequently used in research centers and cause accidents.

Handling precautions:

- 1) Concentrated and hot sodium hydroxide solution is an extremely corrosive chemical, and it particularly decomposes proteins and can penetrate deep into tissue. Therefore, avoid any alkali contact with the skin and clothes.
- 2) Concentrated or hot ammonia water exhibits irritating action, which is weaker than that of sodium hydroxide. Nevertheless, it should be handled cautiously because it generates toxic ammonia gas; the tolerable concentration is 100 ppm.

(1) Sodium hydroxide (caustic soda; NaOH) and potassium hydroxide (caustic potash; KOH)

a. Corrosive and physiological effects

Their aqueous solutions can harshly corrode various metals and generate hydrogen. They penetrate bodies, decompose proteins, and ultimately destroy the tissue. Their corrosive action is particularly pronounced in a molten state. Upon contact of their aqueous solutions with the eyes, vision will decrease or vision loss will occur. Upon ingestion, they cause inflammation of the esophagus and gastric wall and occasionally cause gastric perforations, which may lead to death.

b. Precautions when melting

Melting of solid sodium hydroxide should be carefully conducted; because of the considerable heat generated, its temperature may rise considerably above the boiling point, which may cause it to splash and scatter. To avoid such a mishap, melt the sodium hydroxide while mixing in small quantities of water.

c. Measures for spillage

Rise with water. After the spilled alkali has been diluted, neutralize it with dilute acetic acid, and wipe it off the surface.

d. When it clings to clothes

Immediately rinse the clothes with large quantities of water. Subsequently, neutralize them with dilute acetic acid (2%), and rinse them further with water. Animal fibers such as wool and silk are more prone to corrosion from these alkalis than plant fibers.

(2) Ammonia water (NH_3 aq, aqueous solution with a regular commercial concentration from 25% to 28%)

a. Corrosive and physiological effects

Ammonia water corrodes copper, copper alloys, and aluminum alloys. Ammonia water demonstrates localized irritating action upon contact with the body, but it poses no particular problems unless it gets into the eyes or is ingested. Precautions must be taken to avoid inhalation of the generated ammonia gas; the tolerable concentration is 100 ppm.

b. Precautions for use

Sealed bottles should be uncapped carefully; the internal pressure of the container rises for high ambient temperatures, resulting in the contents to spray out. Thus, while uncapping the containers,

avoid positioning the case right above the cap, and open with the bottle opening facing away from the user.

c. When it spills and clings to clothes

Rinsing with a large quantity of water will remove the ammonia sufficiently.

Likely occurrences:

- 1) When the bottle is opened during summertime, the contents may spray out and cause difficulty in breathing if the spray is received directly upon the face.
- 2) Incomplete closing of the valve of an ammonia cylinder may result in gas leakage, which will necessitate evacuation of the premises.
- 3) The welds of a handmade container wrapped in cloth and filled with ammonia gas may rupture during transport, resulting in ammonia leakage, which causes frostbite and respiratory disorders.
- 4) Direct inhalation of the reaction products of dissolved unreacted ammonia may cause fainting.

Section 4 Toxic and harmful chemicals

Generally, chemicals used in laboratories and research centers are toxic and harmful in nature. These chemicals include deadly poisons, such as cyanide compounds and toxic gas, and widely used chemicals such as benzene and toluene. Although these chemicals may not exhibit considerably acute toxicity, they should be handled carefully considering their chronic toxicity. First, the chemicals used in experiments and generated by reactions should be thoroughly studied in terms of their toxicity, potential for harm, strength, and tolerable concentrations. For toxic or harmful chemicals, their invasive oral or dermal toxicity should be identified. In addition, highly toxic chemicals should be investigated to ascertain alternative methods that do not involve their usage. In cases where their usage cannot be avoided, experimental methods should be determined to minimize their quantities.

Proper caution should be exercised in activities concerning toxic or harmful chemicals; the supervising instructors and bystanders are to be fully briefed, and any accidents should be addressed completely. In particular, improper handling will cause harm not only to the user but also to the bystanders. Additionally, thorough detoxification of the generated exhaust and waste should be incorporated into experimental protocols.

The usage of toxic chemicals is a matter of concern; any misuse, including improper handling and improper management of these substances, may have severe repercussions and even result in loss of life. Consequently, **prevention of theft or loss and proper storage and management of toxic chemicals are essential to the safe usage of these chemicals.** As detailed in part 2 of this section, methods for the storage and management of poisonous and deleterious substances are set forth by law. For safe usage, this institution has enacted the rules for the management of poisonous and deleterious substances specified by Nagaoka University of Technology. Toxic chemicals are to be stored and managed in accordance with these laws and rules.

The hazardous substance classifications (refer to part 2 of this section for further information on poisonous substances and deleterious substances as set forth by law) and the potential for physical harm of toxic chemicals are listed in Tables 5-14 and 5-15, respectively.

Table 5-14 Hazardous substance classifications

Classification	Characteristics	Typical substances
Toxic gas	Gas with tolerable concentration * of 200 mg/m ³ or less.	Arsenic, fluorine, phosgene, and hydrogen cyanide.
Poisonous substances	Lethal oral dose of 30 mg or less for 1 kg of body weight.	Arsenous acid, potassium cyanide, yellow phosphorus, nickel carbonyl, and tetraalkyl lead (specified toxic substance).
Deleterious substances	Lethal oral dose of 30–300 mg for 1 kg of body weight.	Nitric acid aniline, chloropicrin, dimethyl sulfate, and methanol.

NOTE 1) Indicated in terms of the lethal oral dose or minimum lethal dose injected subcutaneously in the case of poisonous and deleterious drugs (specified drugs: those identified by laws concerning the quality, efficacy, and safety of drugs and medical devices; other drugs and quasi-drugs: as set forth in the Poisonous and Deleterious Substances Control Act) and with reference to the tolerable concentration or lethal concentration time for toxic gases, vapors, fumes, or dust.

2) * The minimum concentration that triggers acute or chronic symptoms, which appear after a normal workday; it may not necessarily be proportional to the hourly lethal concentration exposure.

Table 5-15 Physical harm from hazardous substances

Type	Typical substances
a Skin disorders	Skin cornification: Arsenic, cobalt, and dilute alkali solutions. Skin discoloration: Picric acid, silver nitrate, and iodine. Dyschromatosis: Tar, pitch, and arsenic. Acute dermatitis and eczema: Acids, alkalis, chlorodinitrobenzene, formalin, tar, and pitch. Ulcers: Chromium, nickel, acids, and alkalis. Hair and sebaceous glands lesions: Mineral oil, tar, and chloronaphthalene. Hair lesions: Thallium, manganese, etc. Nail plate and peripheral lesions: Selenium, thallium, and fluorine.
b Mucous membrane disorders	Mainly affects the upper respiratory tract: Aldehyde, alkali dust and mist, ammonia, chromic acid, ethylene oxide, hydrogen chloride, hydrogen fluoride, zinc sulfate gas, and anhydrous sulfuric acid. Affects the upper respiratory tract and lung tissue: Bromine, chlorine, chlorine oxide, cyanogen bromide, cyanogen chloride, dimethyl sulfate, fluorine, and iodine. Affects the end airway and alveoli: Arsenic trichloride, nitrogen peroxide, and phosgene.
c Asphyxia	Simple asphyxia: Carbonic acid gas, ethane, helium, hydrogen, methane, nitrogen, and nitrous oxide. Chemical asphyxia: Carbon monoxide, cyanide, hydrogen cyanide, nitril, aromatic nitro compounds (e.g., nitrobenzene and dinitrobenzene), aromatic amines compounds (e.g., aniline and methylaniline), and hydrogen sulfide.
d Anesthesia	Several organic solvents and fat-soluble solids demonstrate anesthetic action, but differ in the degree of action.
e Neurological disorders	Carbon dioxide, halogenated hydrocarbons, methanol, thiophene, tetraethyl lead, manganese, and mercury.
f Hepatic and renal disorders	Carbon tetrachloride, ethane tetrachloride, hexachloronaphthalene, trinitrotoluene, and dioxane. Uranium and cadmium affect the kidneys in particular.
g Hematological disorders	Benzene, lead, radioactive substances, phosphine, and arsenic.
h Hard tissue disorders	Acid mist, yellow phosphorus, and fluorine.
i Pulmonary disorders	Alveoli irritants (pulmonary edema and pneumonia), slightly soluble dust (pneumoconiosis), free silicic acid (silicosis), asbestos (asbestosis), talc (talcosis), agalmatolite (pyrophyllitosis), aluminum (aluminosis pulmonum), coal powder (anthracosis), graphite (graphitosis), welding dust (pneumosiderosis), and beryllium (pulmonary berylliosis).

j	Cancer	Bladder cancer: β -Naphthylamine, benzidine, 4-aminobiphenyl, auramine, and magenta. Skin cancer: Coal tar, pitch, shale oil, soot, and carbon black. Lung cancer: Asbestos, chromate, nickel, coal tar, pitch, and radioactive dust. Nasal and paranasal cancer: Nickel. Leukemia: Radioactive substances and benzene.
k	Other	Allergies: Metal oxides and fumes. Circulatory function disorders: Nitroglycol and nitroglycerine.
l	Radioactive	Radioactive ore, radium, uranium, or plutonium salts, and radioactive argon.

1 Toxicity, toxicity measures, and anti-pollution measures

(1) Toxicity measures

Individual toxicities and measures are described in Section 1.1; experiments involving toxic substances exhibit minimal commonalities that are of notable concern.

- a. Prior to their usage, fully study the toxicity of the chemicals that are utilized and generated in the experiments, involved measures, and experimental methods. Measures for the exhaust of chemicals, washing the body and the eyes, and prompt notification in the event of an accident should be considered.
- b. Avoid inhaling the vapor, fumes, and dust from lethal substances. Wear gas masks and dust masks as required.
- c. Wear rubber gloves and protective masks when handling skin-irritating substances, especially those capable of chemical burns.
- d. Exercise careful conduct when handling skin-penetrating toxic chemicals should be handled with extreme care. In addition, wear rubber gloves as needed.
- e. For the measurement of toxic liquid chemicals and toxic chemical solutions, employ a pipette for poisonous chemicals or rubber-stoppered volumetric pipette for poisonous substances, and do not use the mouth to suck.
- f. In case of any existing chemical allergies, consult a doctor and convey the specifics of the concerned chemical.

(2) Anti-pollution measures

Hazardous or harmful substances that escape untreated through waste or exhaust act as pollutants. Therefore, strict compliance to these anti-pollution measures is necessary.

- a. Several toxic gases, including those yet to be fully investigated, have been identified as air pollutants. Therefore, depending on the gas type, these gases can either be absorbed via appropriate absorbents or detoxified through oxidation or burning.
- b. Odorless substances can be utilized to absorb alkalis and detoxify them through oxidation; this measure is in line with the Offensive Odor Control Law.

- c. The handling rules specified by this university for elements and compounds identified as harmful water-polluting substances along with those for water-soluble salts and laboratory waste thereof are to be strictly observed.
- d. The elements and compounds mentioned above that are water-insoluble solids, especially in small quantities, are transformed into water-soluble salts (e.g., chlorides, sulfuric acid salts, or nitric acid salts) transformed into aqueous solutions and are finally transported for processing to a temporary storage facility for laboratory waste. Large quantities are handled according to the “Laboratory waste processing guide.”
- e. In case of spillage of water-polluting harmful substances on a desk or the floor, collect as much of the substances as possible; handle the water-soluble substances according to the methods detailed in measure “c” of this section. For insoluble substances, handle the chemicals according to the methods presented in measure “d” of this section by transforming them into a soluble salt and rendering into a solution.
- f. The handling of water-soluble salts of elements, which are not harmful water-polluting substances, and liquid waste containing these substances are governed by the “Laboratory waste processing guide.”
- g. Small quantities of the above-mentioned water-soluble solids are transformed into soluble salts, such as chlorides, sulfuric acid salts, or nitric acid salts, and delivered to the same facility as that for the aqueous solution; large quantities are to be handled according to methods specified in measure “d” of this section.
- h. In the interest of safety of laboratory waste handlers, water prohibitive, flammable, and skin-penetrating organometallic compounds, which are poisonous and lethal in nature, should never be included in the general waste. However, this limitation does not apply to those compounds that have been detoxified with organic phosphorus compounds or organic lead compounds and sufficiently diluted according to the measures specified in the “Laboratory waste processing guide.”

1.1 Toxic gas and vapor

The following toxic gasses are often handled in laboratories and research centers:

◇ Tolerable toxic gas concentrations

- 1.0 mg/m³ or less: Arsenic, phosphine, fluorine, bromine, ozone, phosgene, chlorine, acrolein, and diazomethane.
- 10 mg/m³ or less: Zinc sulfate gas, hydrogen fluoride, hydrogen chloride, formaldehyde, hydrogen cyanide, and ketene.
- 50 mg/m³ or less: Carbon monoxide, ethylene oxide, methyl bromide, ammonia, and nitrogen oxide.

100 mg/m³ or less: Methyl chloride.

◇ Tolerable toxic vapor concentrations

0.1 mg/m³ or less: Organic mercury compounds and mercury.

1.0 mg/m³ or less: Nickel carbonyl, hydrazone, and acrolein.

10 mg/m³ or less: Carbon disulfide.

Acute poisoning is a commonly observed phenomenon owing to the large number of existing lethal and poisonous gases; thus, precautions should be strictly observed to avoid such harmful instances.

(1) Toxicity, anti-pollution measures

- a. Experiments using highly toxic gases or chemicals should be conducted using a local exhaust ventilation system and wearing a dedicated (or compliant) gas mask. In addition, ensure satisfactory air flow in the room, occasionally check the gas concentration using a detector, and explore exposure countermeasures in case of accidental gas-mask removal. The detection of gas leaks for highly irritating gases is not a challenging task. However, special precautions should be taken with non-irritants such as hydrogen cyanide, carbon monoxide, nickel carbonyl, mercury, and toxic mercury. Occasionally, experiments are conducted with a canary possessing low resistance to these gases placed in the room.
- b. Considering the risk of acute poisoning, never perform the experiments alone.
- c. Toxic gas and vapor are pollutants, and the reaction resulting capture or oxidation with appropriate absorbents, may result in detoxification or combustion. Incinerate the gases, which may burn on a burner, by using N₂ as the carrier gas.

NOTE: Improper use of the gas mask is extremely dangerous. A specialized or appropriate gas mask (refer to Table 5-16) should be adopted, i.e., the gas mask should have sufficient absorbent capability.

Likely occurrences:

- 1) In cylinders containing corrosive gases such as chlorine. In particular, the valve may rot; in such cases, forcibly opening the cylinder may result in loss of control over the gas release. When the cylinder has a valve that does not open, have it handled by an expert.
- 2) When dealing with toxic gas or vapor, acute poisoning may occur owing to any unidentified gas leakages.
- 3) When dealing with toxic gas or vapor, acute poisoning may occur even after wearing a gas mask. If the gas mask absorbent material has expired, the gas may not be completely absorbed at high concentrations.
- 4) Experiments dealing with chlorine, nitrogen oxides, hydrogen sulfide, or zinc sulfate gas may cause sickness and nausea.

Table 5-16 Gas mask cannisters and corresponding gasses

Gas mask cannister type	Gas type	Gas mask cannister color	Carbon tetrachloride	Benzene	Chloropicrin	Methyl bromide	Tetraalkyl lead	Carbon disulfide	Methyl ethyl ketone	Acrylonitrile	Trichloroethylene	Parathion	Hydrogen chloride	Phosgene	Hydrogen fluoride	Chlorine	Nitrogen oxide	Nitrogen sulfide	Zinc sulfate gas	Hydrogen cyanide	Carbon monoxide	Ammonia	Lead/Zinc
	Organic gas	Black	⊙	⊙	⊙	⊙	⊙	⊙	⊙	⊙	⊙	⊙	△	△	×	△	×	△	×	×	×	×	△
	Regular gas		△	△	△	×	○	○	△	○	○	△	⊙	⊙	×	△	△	△	×	×	×	×	△
	Smoke	White/Black	△	△	△	×	△	△	△	△	△	△	○	○	×	△	△	△	×	×	×	×	⊙
	Acidic gas	Grey	×	×	×	×	×	×	×	×	×	×	×	×	⊙	⊙	○	△	△	×	×	×	×
	Zinc sulfate gas	Orange	×	×	×	×	×	×	×	×	×	×	△	×	○	○	⊙	△	⊙	×	×	×	×
	Hydrogen sulfide	Yellow	×	×	×	×	×	×	×	△	×	×	○	○	○	○	△	⊙	○	×	×	×	×
	Hydrocyanic acid gas	Blue	×	×	×	×	×	×	×	△	×	×	○	○	△	○	△	○	○	⊙	×	×	×
	Ammonia	Green	×	×	×	×	×	×	×	×	×	×	×	×	×	△	×	△	×	×	×	⊙	×
	Carbon monoxide	Red	×	×	×	×	×	×	×	×	×	×	△	△	△	△	△	△	△	×	⊙	×	×
	Firefighting	White/Red	△	△	×	×	×	×	×	×	×	×	△	△	△	△	△	△	△	×	△	×	×

NOTE: ⊙○: Appropriate △: Should be avoided ×: Unusable

1.2 Mercury and mercury compounds

Warnings: Deadly poison, severely poisonous in nature.

◇ Inorganic compounds

Poisonous: Liquid (Hg), solid Hg (ClO₄)₂, HgO, Hg (CN)₂, HgCl₂, Hg₂Br₂, HgBr₂, HgI₂, Hg (NO₂)₂, Hg (NO₃)₂, Hg (SCN)₂, Hg₂SO₄, and HgSO₄.

Deleterious: Hg₂Cl₂.

Unspecified: Hg₂I₂ and HgS.

◇ Organic mercury compounds

Deadly: Liquid (CH₃)₂Hg, (C₂H₅)₂Hg, other low-grade dialkyl mercury compounds, solid CH₃HgCl, C₂H₅HgCl, (C₆H₅)₂Hg, CH₃HgOCOCH₃, C₆H₅HgCl, C₆H₅HgOCOCH₃, mercurphen, afridol, methylaryl, and mercurochrome.

Except for a few compounds that are poorly soluble in water, several inorganic mercury compounds are poisonous. Owing to the residual toxicity of organic mercury compounds, their commercial production manufacture has been discontinued, and a few such compounds are currently allowed for use.

Mercury and its compounds are generally poisonous water pollutants; these pollutants demand utmost attention owing to their low regulation value. Measures for handling materials containing mercury and compounds thereof, including laboratory waste, thermometers, mercury manometers and batteries, and fluorescent lights, should be rigorously adhered to.

In addition, purchases, usage logs, and inventory balances related to mercury and its compounds should be regularly checked.

(1) Mercury and mercury compound poisoning

Mercury poisoning symptoms (upon inhalation of mercury vapor or ingestion of mercury)

- a. Acute:
 - Intraoral inflammation (teeth and throat pain).
 - Respiratory and cardiovascular disorders (chest tightness).
 - Kidney disorders (impaired urination).
- b. Chronic:
 - General fatigue.
 - Bleeding gums.
 - Psychiatric symptoms include irritation, impatience, anxiety, and nervousness resulting from inorganic mercury exposure.
 - Neurological symptoms such as hand tremors caused by inorganic mercury exposure).

(2) Toxicity and hazard measures

- a. Mercury vapor is a deadly poison (tolerable concentration of 0.1 mg/m³). The vapor pressure for a range of ambient temperatures, as shown in Table 5-17, is 100–200 times that of the tolerable concentration. Thus, ensure proper ventilation and seal the mercury containers and mercury waste reservoirs after drowning the mercury in water.
- b. Inorganic mercury compounds generally decompose when heated at relatively low temperatures, generating free mercury vapor; thus, heat these compounds with extreme caution.

c. As organic mercury compounds include further deadly poisons (tolerable concentration of 0.01 mg/m³) and penetrate the skin, liquids and high-pressure vapor should be handled in well-ventilated sites with rubber gloves and gas masks if needed.

Table 5-17 Mercury vapor pressure

Temperature (°C)	Mercury vapor pressure (mmHg)	Mercury air saturation (mg/m ³)
10	0,00049	5.5
15	0,00077	8.6
20	0,00120	13.2
25	0,00184	19.6
30	0,00278	29.6
35	0,00414	43.4

d. Always use a bulb pipette designed for poisonous substances for measuring mercury compound solutions, and ensure that no substances are inhaled through the mouth.

- e. Mercury has a high specific gravity of 13.55; thus, small quantities of mercury are considerably heavy. In addition, as mercury is a deadly poison in its vapor form, it should be sealed in a polyethylene container and then stored in another polyethylene container or glass bottle.
- f. During instances of mercury spillage onto the desk or floor, suck up the large mercury beads with a mercury dropper, and use a feather brush or whiskbroom to sweep it up together along with the dust onto a piece of paper. Thereafter, rinse out a large beaker with water, and only place the mercury inside the beaker. If some mercury falls into dents or gaps, collect it with a syringe or as an amalgam by using an acid surface-treated copper wire or copper plate. Use a large beaker or vat to prevent the mercury from flowing into drains.
- g. If mercury compounds spill out onto the desk or floor, immediately collect them if they are in solid form or wipe up the compounds with a cleaning rag if they are in an aqueous solution. Subsequently, prepare an aqueous solution and follow the processes specified in the "Laboratory waste processing guide."
- h. Mercury compounds include explosive substances (e.g., mercury fulminate acetylides, and azides; refer to Section 2, 2. (2) Explosively decomposing chemicals (see page 98)); thus, take precautions to prevent their evolution.

(3) Anti-pollution measures

- a. Metallic mercury forms an amalgam with the lead in drainage pipes and several other metals, leading to a buildup of sludge in onsite drainage ditches. Furthermore, if this sludge is released, it (i.e., its surface) is oxidized by oxidants, forming an oxide solution, which is then dissolved into acidic drainage, partially transforming into organic mercury. Consequently, spilled mercury should never be disposed of in the sink.
- b. Approximately 1 g of mercury is used in mercury thermometers. For spillage occurring from damaged thermometers, collect the mercury as detailed in Section 1.2(2)f, and finally store it in a mercury waste reservoir. Mercury waste generated from relay units should be handled in the same manner as that for damaged thermometers.
- c. Mercury compounds react with reducing substances in wastewater ditches to yield mercury metal, which behaves as described in measure "a." mentioned above. Therefore, not only liquid waste containing mercury but also containers and sediments should be iteratively collected up to five times and transported to a temporary storage facility for laboratory waste.
- d. If mercury compounds are spilled onto the desk or floor, treat them by following the methods described in Section 1.2(2)g.
- e. Organic mercury compounds are oxidized and rendered inorganic via the methods mentioned below, transformed into their aqueous form, and handled as detailed in measure "c."; 60 mL

concentrated nitric acid and 20 mL permanganese aqueous solution (6%) are added to 1 L liquid waste (Hg concentration of 0.025 mg/m³ or less) and heated to reflux for two hours. When the potassium permanganate has lost its color, reduce the liquid temperature to a value of 60 °C or less, add further 20 mL potassium permanganate aqueous solution. and finally reheat the solution.

- f. Transport any materials that may generate mercury pollution, such as unusable mercury batteries, mercury lamps, or fluorescent lights, to locations designated by the university.
- g. When spillage of organic mercury compounds occurs in a well-ventilated place, soak the compounds in diatomaceous earth or polishing sand, and place in a flask along with water to obtain sulfuric acidity. Subsequently, add potassium permanganate aqueous solution in small quantities to yield mercury sulfate oxide; handle the filtrate together with the cleaning solution as described in measure “c.” Always wear rubber gloves when handling these compounds.

Likely occurrences:

- 1) When mercury is accidentally spilled on a red-hot plate, a risk of absorption of large quantities of mercury vapor occurs, which may lead to fatal acute toxicity.
- 2) Regardless of exposure to tolerable concentrations, sustained exposure and inhalation of mercury vapor over extended periods may result in mercury poisoning.

1.3 Cyanide compounds

Cyanide compounds are high in toxicity and have been identified as pollutants.

◇Poisonous: Potassium cyanide (KCN), sodium cyanide (NaCN), hydrogen cyanide (HCN), cadmium cyanide [Cd(CN)₂], silver cyanide (AgCN), gold cyanide (AuCN), copper cyanide [CuCN (I), Cu(CN)₂ (II)], gold (I) potassium cyanide [KAu(CN)₂], gold (II) potassium cyanide [KAu(CN)₄], nickel cyanide [Ni(CN)₂], and nickel potassium cyanide [Ni (CN)₂ · 2KCN].

◇Unspecified: Ferrocyanide salt and complex salts thereof: Na₄ [Fe (CN)₆], K₄ [Fe (CN)₆], and complex salts thereof.

Ferricyanide salt and complex salts thereof: Na₃ [Fe (CN)₆], K₃ [Fe (CN)₆], and complex salts thereof.

(1) Toxicity measures

- a. Potassium cyanide (KCN) and sodium cyanide (NaCN) are toxic chemicals and should be stored in a prescribed location with safety considerations.
- b. Hydrogen cyanide (HCN) is a toxic gas; thus, it should be properly handled.
- c. While sampling a solution, observe the guidelines in Section 1.(1)e, and utilize a poisonous chemical pipette or rubber-stoppered bulb pipette for poisonous substances to avoid accidental inhalation through the mouth.

- d. In case of accidental ingestion, consume a large quantity of water, and insert finger into throat to induce vomiting; repeat this step three times and received treatment from the doctor immediately.

(2) Anti-pollution measures

- a. Hydrogen cyanide and dicyanogen have been identified as air-polluting substances and thus should be released only after detoxification via alkali absorption and oxidation.
- b. Cyanide compounds containing heavy metals (e.g., yellow potash, red potash, and ferrocyanide metal complex salts) are transported to temporary storage facilities for laboratory waste. In particular, other cyanide compounds are broken down into their constituents. However, if experienced faculty members are unavailable or no safe facilities for decomposition are present, these compounds are to be transported to a temporary storage facility. Nevertheless, the disposal of these compounds is regulated by the “Laboratory waste processing guide.”
- c. If these chemicals are spilled onto the desk or floor, store them according to methods described in Section 1.(2)e, and treat as detailed in measure “b” of this section.

1.4 Other inorganic toxic and harmful substances

Many of the chemical substances infrequently used at this university are toxic and require environmental protection precautions. These chemicals chiefly consist of cadmium compounds, lead and lead compounds, chromium compounds, arsenic, antimony, bismuth compounds, and phosphorus compounds thereof. The inorganic chemicals are summarized in Table 5-18. In cases wherein these toxic and harmful substances must be dealt with, carefully read the details concerning the appropriate materials and receive detailed instructions from the instructor.

Table 5-18 Physical effects of inorganic toxic and harmful chemicals

Effects Chemicals	Direct effects	Chronic effects
Cyanide compounds	<p>Cyanides affect body tissues, causing asphyxia and death.</p> <p>Poisoning symptoms usually appear within several seconds to minutes, causing headaches, dizziness, disturbance of consciousness, spasms, hypothermia, and death.</p> <p>Small quantities may cause dizziness, headaches, tinnitus, vomiting, elevated breathing, elevated pulse, further disturbance of consciousness, spasms, and death.</p> <p>The fatal dosage for KCN ranges from 150 to 300 mg.</p>	<p>Consumption in small doses over an extended period causes chronic poisoning.</p> <p>Symptoms include headaches, nausea, and tightness in the chest and abdomen.</p>
Alkyl mercury	<p>Consumption in small doses causes nausea, vomiting, stomach aches, diarrhea, stomatitis, and hand tremors.</p>	<p>Memory loss, loss of concentration, headaches, insomnia, impaired taste and smell, neuralgia, and overall central nervous system disorders such as neurological weakness (causes of Minamata disease) when consumed for a considerable period.</p>
Total mercury	<p>Consumption of large doses results in teeth rot and bloody stool (i.e., signs of inorganic mercury poisoning).</p>	
Organic phosphorus	<p>Mild: General fatigue, headaches, dizziness, excessive sweating, nausea, and vomiting.</p> <p>Moderate: Abnormal crying, miosis, muscle atrophy, speech impairment, and vision loss.</p> <p>Severe: Impaired consciousness, general spasms, incontinence, and death.</p>	
Cadmium	<p>Blocks the reabsorption of renal urinary cells and causes loss of calcium and calcium imbalance in the body followed by osteomalacia. Bone changes owing to pregnancy, lactation, menopause, and aging as well as calcium and protein deficiencies; may trigger further bone changes (as evident in Itai-itai disease).</p>	
Lead	<p>A large dose of lead in the body causes acute toxicity, stomachache, vomiting, diarrhea, and urinary retention; severe gastroenteritis and consequent shock may cause death.</p>	<p>Prolonged introduction of small doses of lead to the human body causes loss of appetite, constipation, general fatigue, anemia, arthritis, stomachache, limb paralysis, visual impairment, spasms, and coma. Accumulation of lead in the body is characterized by a daily consumption of 0.5 mg or more.</p>

Chromium (hexavalent)	<p>Large doses of chromium cause vomiting, urinary retention, shock spasms, coma, and uremia, eventually leading to death.</p> <p>Contact with the skin causes dermatitis, edema, and ulcers. For concentrations of 100 ppm or more, the effects on the skin are noticeable.</p> <p>If more than 0.1 ppm chromium is consumed orally, symptoms such as nausea are observed.</p> <p>The lethal dose is approximately 5 g.</p>	
Arsenic	<p>Large doses of arsenic causes acute toxicity. Common symptoms include illness, nausea, diarrhea, dehydration, stomachaches, noxious exhalations, incontinence, thirst, and decreased urine output within 1 hour of ingestion.</p> <p>At higher doses, death occurs owing to severe gastroenteritis symptoms, bloody stool, hypothermia, hypotension, spasms, coma, and circulatory disorders.</p> <p>The lethal dose is approximately 120 mg, but a dose of 20 mg can be dangerous as well.</p>	<p>Consumption of small doses over a long time causes tactile disorders in the hands and feet, bronze coloring of the skin, edema, and cornification on the palms and soles of feet.</p> <p>Arsenic may cause nausea, vomiting, stomachache, lacrimation, hepatomegaly and hepatitis, leading to death from cardiovascular disorders. The chronic toxicity dose in tap water approximately ranges from 0.2 to 0.4 ppm.</p>

1.5 Organic toxic and harmful substances

Commercially available organic chemicals that are designated as poisonous or deleterious substances are listed in Table 5-19. These substances include toluene ($C_6H_5CH_3$), methanol (CH_3OH), chloroform ($CHCl_3$), methyl iodide (CH_3I), acetonitrile (CH_3CN), acrylonitrile ($CH_2=CHCN$), and carbon tetrachloride (CCl_4), which are frequently handled on a regular basis.

In general, solid organic compounds are measured by weight. In the case of liquids, if they are specified by weight, the volume is calculated from the difference before and after weighing or calculated from the specific gravity. If specified by volume, they are measured with a graduated cylinder, rubber-stoppered graduated pipette, or syringe.

In addition, as reactions are performed in sealed reaction vessels and under reflex conditions, the toxicity of the chemicals used for raw materials do not pose any significant challenges. For a highly toxic products, the extraction, concentration, distillation, and crystallization are extremely time-consuming processes; thus, caution should be taken to prevent inhalation of vapors or contact with the skin. In other words, proper care should be exercised for toxic substances that emanate deadly vapors such as mercury or organic mercury or penetrate the skin such as tetraethyl lead, phosphorus pesticides, and dimethyl sulfate.

In particular, if the waste does not consist of any mercury compounds, an appropriate medium should be employed for transformation into liquid waste, and this waste should be transport to a temporary storage facility for laboratory waste. The following precautions should be observed to ensure the health and safety of the staff present:

- a. Substances listed in Section 2, 1. (2) Spontaneous pyrophoric substances and Section 2, 1. (4) Water prohibitive substances should be treated at their source (certain compounds such as aluminum compounds cause severe chemical burns). Prior to treatment, the substances should be brought in according to the instructions from the faculty and staff to identify their names.
- b. Skin-penetrating poisonous and deleterious substances such as tetraethyl lead, tetramethyl lead, dimethyl sulfate, and phosphorus pesticides should be treated as much as possible at the source. If these compounds are to be transported for treatment, they are first diluted with inactive solvents as described in measure "c" mentioned below, the compound types are subsequently contained, and their concentrations and amounts are finally identified.
- c. The general dilution standard with regular solvents (solvents not specified for poisonous and deleterious substances) is 1% for poisonous substances and 10% or less for regular deleterious substances. Thus, vapor pressure is approximately one-tenth of that normally observed for relatively low boiling point compounds.
- d. Irritating noxious chemicals are diluted as needed prior to transportation for treatment.
- e. If there is no suitable solvent and oxides and hydroxides are harmful in nature, treat the chemicals with mineral acid after burning or oxidative decomposition and subsequently transport as a salt solution.
- f. Platinum, gold, and silver present in the solutions are either reduced with an appropriate reducing agent such as formalin or recovered in metal form via ion exchange
- g. For mercury compounds, see Section 4, 1.(2).
- h. For treatment of organic peroxides, see Section 2, 1.(1).

Table 5-19 Main organic solvents and toxicity

Organic solvent name		Main harmful actions					Notes	
		Liver	Kidneys	Hematopoietic organ	Neurological			Skin mucous membrane
					Anesthesia	Other		
Carbonization hydrogen	Petroleum ether				△		△	Be careful of mixed benzenes.
	Petroleum benzine				△		△	"
	• n-Hexane				△		△	
	Cyclohexane				○		○	
	• Benzene	△	△	⊙	○	○	○	May result in reduced white blood cells, red blood cells, thrombocytopenia, or addiction.
	• Toluene	△	△	○	○	○	○	Mixed benzenes may cause addiction.
Alcohol	• Methanol	△	△		⊙	○	△	Vision loss from neurological disorders or formaldehyde generated in vivo.
	Ethanol	△	△		○		△	
	cyclohexanol	△						
Ether	Ether	△	△		⊙	○	△	May cause addiction.
	Tetrahydrofuran	△	△		○		⊙	
	• Dioxane	○	○		△		△	
Ketone	Acetone				○		△	
	Methyl ethyl ketone				○		△	
	• Furfural				○			
Chlorinated hydrocarbons	Methylene dichloride	△			⊙		○	
	• Chloroform	⊙	○		⊙		△	
	• Carbon tetrachloride	⊙	○		⊙		△	
	Ethylene trichloride (trichloroethylene)	△	△		⊙	○	△	Cases of peripheral neurological abnormalities, multiple mental illnesses, and addiction.
	Chlorobenzene	△	△	△	○		△	
Ester	Methyl acetate				○	○	△	Ophthalmic nerve disorders and risk of vision loss.
	Ethyl acetate				○		△	
Other	Pyridine	○	○		○	○	△	Central nervous system dyskinesia.
	• Dimethylformamide	⊙	△				⊙	
	Dimethyl sulfoxide						○	A solution of poisonous substances is dangerous as it penetrates skin and mucous membranes.
	• Carbon disulfide	○	○		⊙	⊙	△	Psychiatric schizophrenia-like symptoms and multiple neurological disorders.

NOTE 1) Toxicity strength shown in order of $\odot > \circ > \triangle$.

2) Organic solvents with \bullet to the left of their names are those substances for which contact with the skin may result in the amount absorbed percutaneously reaching a degree that cannot be ignored in terms of health effects on the whole body or the absorption amount, as listed in Table I-1 of the recommendations for tolerable concentrations by the Japan Society for Occupational Health (2022, Industrial Hygiene Journal, 2022,64,253-285, <https://www.sanei.or.jp/files/topics/oels/oel.pdf>).

2 Storage and management of poisonous and deleterious substances

Because hazardous substances may be fatal to humans, precautions must be fully taken to prevent abuse or improper handling. Accordingly, the “Poisonous and Deleterious Substances Control Act” (hereinafter referred to as “the Act”) was enacted, and toxic substances should be properly managed in accordance with the specified regulations. In “the Act”, toxic substances are listed as poisonous substances (those listed in Table 1 of “the Act” other than drugs and quasi-drugs), deleterious substances (those listed in Table 2 of “the Act” other than drugs and quasi-drugs), and specified toxic substances (those listed in Table 3 of “the Act”). Poisonous substances are more toxic than deleterious substances; however, as mentioned below, storage protocols for both these types of substances are similar, except for labelling.

A list of these poisonous and deleterious substances and related information can be obtained from the following websites:

<http://www.nihs.go.jp>

(Ministry of Health, Labour & Welfare, National Institute of Health Sciences website)

<http://www.nihs.go.jp/law/dokugeki/dokugeki.html>

(Poisonous and Deleterious Substances Control Act, Poisonous and Deleterious Substances Database)

The poisonous and deleterious substances that are frequently used in laboratories are listed in Tables 5-20 and 5-21, respectively. In addition, because these poisonous and deleterious substances are listed on chemical containers and reagent catalogs (in the case of Japanese reagent companies), they can be easily distinguished from general chemicals.

Poisonous and deleterious substances set forth in “the Act” also account for social circumstances, chemical distribution, and other factors; thus, “the Act” fails to encompass all toxic substances. For example, toluene is specified, but not benzene. In addition, as methyl chloride and ethyl chloride are deleterious substances, propyl chloride and butyl chloride may be considered similar to deleterious substances. In other words, even if a compound has not been specified as a poisonous or deleterious substance, if it shares similar properties, it should be handled as a highly toxic substance.

The rules for the management of poisonous and deleterious substances at Nagaoka University of Technology have been enacted in accordance with the “the Act.” Poisonous and deleterious substances set forth by “the Act” and other chemicals set forth by the university president should be stored and managed in accordance with these rules. The gist of these rules is outlined below:

1. When purchasing, using, and disposing toxic and deleterious substances, immediately log them into the management system for lab chemicals (IASO) after purchase, and use these substances while managing the amounts through the weight management system; after its usage, perform empty bin treatment and waste procedures, and cancel the registration via the chemical management support system (Section 1.1).
2. Toxic and deleterious substances are securely stored in special lockers separate from those for general chemicals made of metal or similar material with safety measures in place to prevent spillage in the event of earthquakes. Warehouses and containers are labeled “non-medical” and “poisonous substances” in white letters on a red background for poisonous substances and “deleterious substances” in red letters on a white background for deleterious substances.
3. If there is any theft or loss of toxic or deleterious substances, immediately report such instances to managers (e.g., supervising faculty) responsible for poisonous or other substances.
4. Fully detoxify the waste and subsequently treat it according to the rules for waste treatment. For example, because toxicity may have serious effects even in small amounts, adhere to the directions provided by the supervising faculty.

In addition, the following substances should be securely managed according to other laws irrespective of their poisonous or deleterious nature.

Hazardous substances: Potassium chlorate and sodium chlorate.

Narcotics: Morphine, opium, codeine, heroin (diacetylmorphine), cocaine, marijuana, hashish, and lysergic acid diethylamide.

Stimulants: Phenylamino propane hydrochloride, phenylmethylaminopropane hydrochloride, ephedrine hydrochloride, adrenaline, amphetamines, Benzedrine, Dexedrine, Dexamyl, Mezadrine, methamphetamine, and Biphphetamine.

Poisonous and deleterious substances are generally described as hazardous substances in the Fire Services Act, but they simultaneously exhibit toxic properties. Consequently, during storage, precautions must be taken against explosions or fire by considering the designated quantities and mixing prevention rules described in Sections 1 and 2. In addition, if toxic and deleterious substances are radioactive, they should be handled as described in Chapter 8.

Table 5-20 "Poisonous substances" specified in “the Act” used with relative frequency in laboratories

-
- * Aryl-alcohol
 - * Phosphoryl chloride
 - * Yellow phosphorus
 - * Curare
 - * Phosphorus pentachloride, phosphorus trichloride, and phosphorus trifluoride
 - * Boron trichloride and boron trifluoride
 - * Diacetoxypipene
 - * Tetraalkyl lead (specified toxic substance)

- * Inorganic cyanide, hydrogen cyanide, and sodium cyanide
- * Dinitrocresol and dinitrocresol salts
- * Sulfur tetrafluoride
- * Diborane
- * Mercury and mercury compounds
- * Strychnine
- * Selenium and selenium compounds
- * Nicotine and nicotine salts
- * Nickel carbonyl
- * Arsenic and arsenic compounds
- * Hydrogen fluoride
- * Phosgene
- * Methyl phosphonic dichloride
- * Methyl mercaptan
- * Monofluoroacetic acid, monofluoroacetic acid salts, and monofluoroacetic acid amide (specified toxic substance)
- * Aluminum phosphide/accelerant (specified toxic substance)
- * Hydrogen phosphide
- * Phosphorus sulfide
- * Thiosemicarbazide

Because there are several other substances classified as pesticides, caution is necessary.

Parathion, methyl parathion, scharadan, methyl dimeton, and tetraethyl pyrophosphate are specified toxic substances.

Table 5-21 "Deleterious substances" specified in "the Act" used with relative frequency in laboratories

- * Ammonia
- * Hydroxylamine and salts thereof
- * Chlorine, bromine, and iodine
- * Hydrogen chloride, hydrogen bromide, and hydrogen iodide
- * Hydrogen peroxide, sodium peroxide, and urea peroxide
- * Potassium, sodium and sodium-potassium alloy
- * Hydrofluorosilicic acid and silicofluoride salt
- * Fluoroboric acid and salts thereof
- * Sodium cyanate
- * Sulfuric acid, fuming sulfuric acid, and nitric acid
- * Sodium hydroxide and potassium hydroxide
- * Inorganic zinc salts
- * Inorganic gold salts
- * Inorganic silver salts
- * Inorganic tin salts
- * Inorganic copper salts
- * Dichromic acid, chromic anhydride, and chromic acid salts
- * Sodium nitrate, thallium acetate, and thallium sulfate
- * Antimony compounds
- * Cadmium compounds
- * Barium compounds (except barium sulfate)
- * Lead compounds
- * Soluble uranium compounds
- * Chlorates
- * Sodium chlorite

- * Nitrites
- * Trichlorosilane
- * Ammonium hydrogen difluoride
- * Vanadium pentoxide
- * Zinc phosphide
- * Methyl nitrite
- * Dimethyl sulfate
- * Thionyl chloride
- * Triaryl tin hydroxide, trialkyl tin hydroxide, and salts and anhydrides thereof
- * Acrylonitrile, acrylamide, acrylic acid, and methacrylic acid
- * Acrolein
- * Aniline, aniline salts, *N*-alkyl aniline, and 2-chloro aniline
- * Ethylene oxide
- * Epichlorohydrin, and ethylene chlorohydrin
- * Formic acid (90% or more)
- * Oxalic acid
- * Formaldehyde
- * Methanol, toluene, xylene, ethyl acetate, methyl ethyl ketone, and carbon disulfide
- * Methyl chloride, ethyl chloride, chloroform, and carbon tetrachloride
- * Methyl bromide, ethyl bromide, dichlorobutane, 1,2-dibromoethane, dibromo chloropropane, and 1-chloro-1,2-dibromoethane
- * Methyl iodide
- * Dichloroacetate, trichloroacetic acid, monochloroacetate, and sodium chloroacetate
- * Monofluoroaceto-*p*-bromoanilide and monofluoroaceto-*p*-bromobenzyl amide
- * Chloroacetyl chloride
- * Methylamine (40% or more), dimethylamine, and cyclohexylamine
- * 2-aminoethanol
- * Phenol, cresol, and β -naphthol
- * Nitrobenzene and 2,4-dinitrotoluene
- * Dichlorodinitromethane and tetrachloronitroethane
- * Toluidine, *N*-alkyl toluidine, and toluidine salts
- * Quinoline
- * Picric acid and salts thereof
- * Chloropicrin
- * Organocyno compound (except long-chain nitrile compounds: *m*- phthalonitrile and *p*-phthalonitrile)
- * Trifluoromethanesulfonic acid
- * Hydrazone monohydrate and hydroxyethyl hydrazine
- * Chloroprene
- * Acetylene dicarboxylic acid
- * Emamectin
- * Chlorosulfonic acid
- * 2-chloroethyl trimethylammonium
- * Di (2-chloroisopropyl) ether
- * 2,4-dichloro-6-nitrophenol and salts thereof
- * Cycloheximide
- * 3,5-dibromo-4-hydroxy-4'-nitroazobenzene
- * 5-dimethylamino-1,2,3-trithiane and salts thereof
- * Sulfonal
- * 2,4,5-trichlorophenoxy acetate and esters thereof

- * Tributyltrithiophosphate
- * 2-hydroxy-4-methylthiobutanoic acid
- * Blasticidin S
- * Hexamethylenediisocyanate
- * Heptachlorophenol (PCP) and salts thereof
- * Methylsulfonal
- * Zinc methyldithiocarbamate
- * Dimethyl methyl phosphonate
- * *N*-methyl-1-naphthyl carbamate
- * *p*-dimethylaminophenyldiazonium sulfate and salts thereof
- * Rhodanacetic acid ethyl
- * Rotenone
- * Anise

For other pesticides, proceed with caution for substituent names, such as phosphonate, dithiophosphate, thiophosphoramidate, or imidate for chemicals with such names.

As part of environmental conservation efforts, the Nagaoka University of Technology (NUT) categorizes the wastewater generated on campus into the following four types, domestic wastewater, experimental wastewater, experimental liquid waste, and rainwater. NUT has set up an operation management system and mechanism for the disposal of experimental liquid waste, from collection to external treatment. In this section, “experimental liquid waste” refers to the liquid waste originated from experiments and cleaning solutions of laboratory containers through the second rinse. Cleaning solutions discharged after the third rinse and cooling water are categorized as “experimental wastewater.” Solid waste is categorized as “experimental waste.”

Precautions and practices associated with each type of waste are detailed below.

1 Domestic wastewater

Domestic wastewater is the wastewater produced by human activities in households, such as water from toilet, wash basin, bath, and laundry. Domestic wastewater is collected by the drains of each building and is passed through the dedicated piping towards its discharging destination at the Nagaoka City’s public sewer system.

2 Experimental wastewater

Experimental wastewater passes through a dedicated drain installed in each laboratory. The released experimental wastewater passes through a dedicated pipeline, undergoes water quality testing regularly, and is discharged into the public sewage system (Nagaoka City).

Researchers must take extra care not to confuse the drain for experimental wastewater with the drain for domestic wastewater.

3 Experimental liquid waste

In accordance with Nagaoka University of Technology Rules of Handling Experimental Liquid Waste (Regulation No. 44; April 1, 2004), experimental liquid waste is separated and stored in designated containers in laboratories. The classification method is described in the **handbook for the treatment of experimental liquid waste**. The separated and stored experimental liquid waste are transported and stored temporarily in designated locations or in temporary storage areas that have been set up specifically for this purpose in each department or academic center.

The experimental liquid waste is collected according to the disposal application submitted by the discharger. The collection of organic and inorganic experimental liquid waste is outsourced to a specialized company for off-campus treatment.

4 Rainwater

Rainwater drainage from the site, such as water flow from the building roof and roads, is discharged through a dedicated pipeline or drainage ditch into the Osawa River. It is therefore crucial for researchers to stay alerted to any potential risk of water pollution as the water flow from the site is discharged directly into the river.

5 Experimental waste

Experimental waste refers to granules, powders, precipitates, sludge, and solids of harmful substances as well as unnecessary waste reagents generated by educational and research activities. Because such experimental waste falls under the category of industrial waste and/or specially controlled industrial waste, its disposal must be taken care of by external specialized companies. These companies must be contacted through the Section of Contracts, Division of Financial Affairs.

It is the sole responsibility of each laboratory to properly sort and store its generated experimental waste according to the designated categories. Each major and center on campus will be responsible for transporting their stored experimental waste using appropriate specified transportation methods to the locations for their collection by the specialized company.

During carriage or transportation, experimental waste must be appropriately labelled. Each label should clearly state the name of the laboratory, date, and classification type of the experimental waste. Labels must be attached to every waste container (i.e., plastic bags and cans). A university-wide format for the labels has been prepared and made available for this purpose. In addition, it is the sole responsibility of each laboratory to contract a specialized company for the collection of reagent bottles with remaining solution or unopened reagent bottles marked for disposal. Such waste may not be disposed in normal disposal areas (please contact the Section of Contracts, Division of Financial Affairs).

Any further questions regarding the disposal of experimental waste can be directed to the Safety and Health Management Committees selected by each major and center. Unknown classifications must always be consulted prior to disposal. Discretionary disposal with ambiguous classification might cause accidents or fire, leading to a large social problem.

The table below shows the classification of experimental waste at NUT (see item 3 above for information pertaining to experimental liquid waste, which, similar to experimental waste, is categorized as industrial waste).

Table 7 Categories of Experimental Waste at Nagaoka University of Technology

Categorization number and type	Examples of waste
1. Quasi-Infectious Waste	<ul style="list-style-type: none"> • Waste from the Physical Education and Health Care Center • Syringes and Quasi Syringe (glass or plastic) • Needles
2A. Incombustible Laboratory Waste (Metals)	<ul style="list-style-type: none"> • Metal products, pieces, polishing chips and cutting chips (18-liter drum volume limit) • Metal foils (e.g. aluminum foil) • Scalpels (non-medical use) • Metal reagent cans (<u>washed and dried</u>) (e.g. 18-liter drum)
2B. Incombustible Laboratory Waste (Glass)	<ul style="list-style-type: none"> • Glass products, pieces, and scraps • Glass reagent bottles (<u>washed and dried</u>) (Labels do not require removal. Removed caps must be disposed as Category 3) • Glass petri dishes and ampoules
2C. Incombustible Laboratory Waste (Others)	<ul style="list-style-type: none"> • Ceramic products (e.g. crucible), their fragments and powders • Concrete pieces (garbage bag volume limit), gypsum • Other incombustible composite material • Silica gel • Desiccants (e.g. CaCl₂ calcium chloride, MgSO₄ magnesium sulfate, Na₂SO₄ sodium sulfate)
3. Combustible Laboratory Waste	<ul style="list-style-type: none"> • Papers used in experiments (e.g. Kimwipes, filter paper) • Gauze, absorbent cotton used in experiments • Plastic petri dishes, tubes, pipettes, etc. • Gloves (rubber or vinyl) • Plastic reagent bottles (<u>washed and dried</u>) (Labels do not require removal) • Plastic caps of reagent bottles • Sterilized culture medium • Autoclave-sterilized waste in regular garbage bag (no biohazard symbol)

As mentioned above, researchers in each major and center must follow the administrative instructions and implement the disposal protocol for liquid waste and waste discharged following the experiments and practical training. It is important that the researchers adopt a sense of responsibility, awareness, and cooperation concerning the treatment and disposal of waste.

Refer to the handbook for the treatment of experimental liquid waste.

Section 1 Introduction

The progress of biotechnology, specifically genetic manipulation, has opened wide research possibilities to investigate and manipulate biological materials from an engineering perspective. However, handling biological materials involves the potential for severe health hazards due to pathogenic microorganisms, toxins, and other hazardous substances, in addition to risks caused by genetically modified organisms and related products. Therefore, it is essential to follow the guidelines stipulated by law and ensure individual and collective safety while researching on biotechnology.

Section 2 Microbial Experiments

1 Laws and regulations related to pathogenic microorganisms

The possession and utilization of pathogenic microorganisms, including genetically modified microorganisms, accompanies risks of infection. Therefore, spread prevention and infection control measures are necessary. In particular, as a measure to counter biological terrorism, the law on infectious disease necessitates the proper management of specified pathogens that belong to Class I-IV, as listed in Figure 7-2-1. Every year, Nagaoka University of Technology (NUT) also reports annually to the government whether or not it owns specific pathogens and what they are.

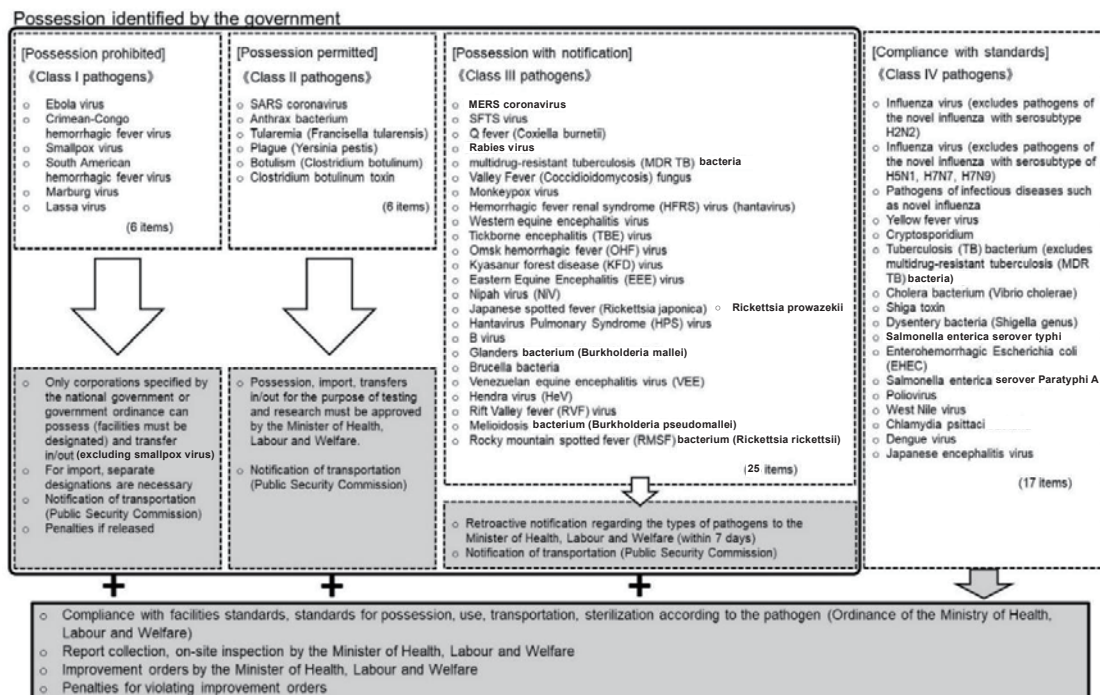

Figure 7-2-1. Diagram for the proper management of pathogens (cited from Japan Ministry of Health, Labour and Welfare website, www.mhlw.go.jp)

Class I specified pathogens cannot be possessed by the University. The possession and use of Class II specified pathogens require advance application and approval. Notification is required for the possession of Class III specified pathogens. The usage of specified pathogens requires specific infection control measures corresponding to each biosafety level (BSL) (See <http://www.nite.go.jp/nbrc/list/risk/description.html#niid>). Furthermore, it is necessary to ensure that the implemented measures are in accordance with the associated risk level, given in Table 7-2-1. Figure 7-2-2 shows an example of facility standards for laboratories that handle Class IV pathogens classified as BSL2 equivalent.

◎: Legal obligation/penalty ○: Improvement order

	Class I	Class II	Class III	Class IV
Minister designation required for possession/import	◎			
Permit required for possession/import		◎		
Notification required for possession/import			◎	
Creation of regulations to prevent infectious disease	◎	◎		
Appointment of pathogen biosafety officer	◎	◎		
Education and training	◎	◎		
Sterilization (if designation or permit is revoked)	◎	◎		
Bookkeeping obligation	◎	◎	◎	
Facility standards	◎/○	◎/○	○	○
Storage standards	○	○	○	○
Notification of transportation (to the Prefectural Public Safety Commission)	◎	◎	◎	
Notification of accidents	◎	◎	◎	◎
First aid in the event of disaster	◎	◎	◎	◎

Figure 7-2-1. Legal obligations and penalties for parties in possession of specified pathogens (cited from www.mhlw.go.jp).

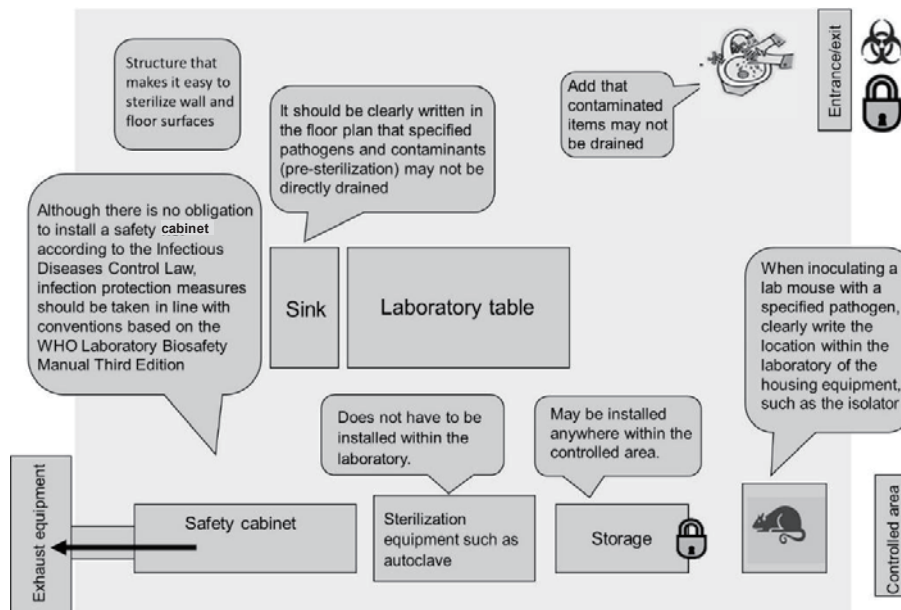

Figure 7-2-2. Facility standards for a laboratory that handles Class IV pathogens classified as BSL2 equivalent (cited from www.mhlw.go.jp)

In addition, the microorganisms isolated from the natural world must be treated appropriately if they are recognized as pathogenic microorganisms in their classification. If they are classified as a specified pathogen, a permit or notification must be obtained from the competent authority. If they correspond to a Class I specified pathogen, they must be discarded.

2 Handling of Microorganisms

Even non-pathogenic microorganisms may contaminate the research environment and hinder experiments by inviting the inclusion of other microorganisms. If one's personnel immune system is vulnerable due to a disease or medical treatment, an infection may occur from an opportunistic unlisted or unrated pathogenic microorganism. An unnecessary pathogenic microorganism may be contained within a group of microorganisms isolated from nature. Therefore, researchers must pay particular attention to the following points when conducting experiments using microorganisms:

- (1) Wear work clothes, such as lab coats, during experiments to prevent the adhering of microorganisms.
- (2) To avoid contamination from non-target microorganisms, strictly enforce the sterilization of laboratory equipment and disinfection of laboratory tables and hands before starting an experiment.
- (3) Avoid sucking the pipette using your mouth. Eating and drinking must be prohibited in the laboratory.
- (4) Cultivated microbial samples must be sterilized or disinfected prior to disposal.
- (5) Instruments used for cultivation must be sterilized or disinfected after each use.
- (6) When using pathogenic microorganisms, strictly enforce:
 - the use of lab coats and safety pipette fillers,
 - the sterilization or disinfection of samples and instruments after use,
 - the sterilization or disinfection of laboratory tables,
 - and the disinfection of hands and fingers after conducting experiments to prevent infection and contamination.

If there are concerns of potential infection due to accidental ingestion, follow the necessary measures, such as administering antibiotics or neutralizing antibodies/serum.

Section 3 Animal Experiments

Animal experiments are necessary for the development in the fields of life sciences and medicine. However, it remains essential to give sufficient and ethical considerations for the animal welfare.

1 Rules and Regulations Regarding Animal Experiments

The Act on Welfare and Management of Animals was revised in 2005 due to the growing awareness of animal welfare, and the international principles of the Three Rs were enforced for experimental animal:

(1) Replacement

Avoid or replace the use of animals as much as possible.

(2) Reduction

Minimize the number of animals used for scientific experimentation purposes.

(3) Refinement

Minimize the pain, suffering, distress, or lasting harm that laboratory animals might experience.

The following regulations are established pertaining to the proper care and use of experimental animal, “Standards relating to the Care and Keeping and Reducing Pain of Experimental Animal” (Ministry of the Environment) and “Basic Guidelines to Conduct Animal Experiments at Research Institutes” (Ministry of Education, Culture, Sports, Science and Technology, hereafter referred “MEXT”). Based on these regulations, NUT has organized an Animal Care and Use Committee and established its own “Animal Care and Use Regulations”.

Animal experiments must be only conducted at the laboratory that be applied for in advance. In addition, experiment researchers must participate in the animal experiment workshops held every year and acquire sufficient knowledge about experimental animal and experiments. Furthermore, they must consult the animal experiment manager or the NUT Animal Care and Use Committee regarding the experiment plan to ensure that safety regulations are met and to validate their experimental plan. Upon completion of the aforementioned steps, the plan of the animal experiment could be transferred to the President office for approval. They must perform periodic self-check of the animal experiments and report the implementation status to the President.

2 Handling of Experimental Animal

Researchers must strive for the appropriate use of experimental animal. They are required to ensure that they minimize pain and suffering of the experimental animal and use measures such as heat insulation. To minimize the distress and suffering of the experimental animal, it is necessary to refine and improve research techniques and set humanitarian endpoints (timing for euthanasia). If anesthesia is involved in the study, an appropriate anesthetic must be selected considering various viewpoints such as the type and age of the animal, type of pain, and stability associated with the surgical procedure.

Pathogens of major zoonotic diseases

Pathogen (disease that transmits to humans)	Infectable species
Hantavirus (hemorrhagic fever with renal syndrome, HFRS)	Rats
Lymphocytic Choriomeningitis Virus (LCMV)	Mice, hamsters
Salmonella (food poisoning)	Many animal species such as mice and rats
Dermatophyte (tinea capitis, tinea pedis/athlete’s foot)	Many animal species such as mice and rats

Experimental animal may carry zoonotic pathogens. Therefore, researchers are required to consider animal allergies and anaphylactic shocks caused by allergens such as the feces, urine, saliva, and blood of experimental animal. To ensure safety of researchers, the following precautions must be taken:

(1) Animals used in research experiments must be purposefully produced. Test results of genetic and

microbial monitoring must be always attached to experimental animal upon their reception.

- (2) Strive to prevent stabs and wounds caused by laboratory equipment, and bites and scratches caused by animals. Wear thick gloves when handling animals larger than rats.
- (3) Avoid eating, drinking, smoking, or applying makeup in animal laboratories to prevent oral infection.
- (4) Wash and disinfect hands, and wear gloves and masks before and after animal experiments.
- (5) Keep the animal laboratory clean and organized.
- (6) Injection needles, scalpels, contaminated equipment, and other contaminants used in the experiments should be sterilized and then disposed in appropriate containers. These are to be considered as essential measures to prevent infections or incidents with the cleaning agents and personnel.
- (7) In the event of an accident, take measures to minimize the hazards from contamination and infection. Notify the experiment manager immediately.

Section 4 Recombinant DNA Experiments

1 Regulation on Recombinant DNA Experiments

Genetic recombination allows researchers to utilize the structure and function of organism's genes. Nonetheless, it has become an indispensable, important technology applied in a wide range of studies and industries in the field of life sciences. Its application includes the elucidation of cancer and other intractable diseases, mass production of rare drugs such as insulin and interferon, and breeding of useful microorganisms and crops.

As this new technology adds properties that did not originally exist in living organisms, genetic recombination can create unpredictable effects. Thus, researchers are urged to take careful measures while handling the recombinant DNA technology. It is worth mentioning that many arguments existed to question the safety of genetic recombination and oppose the use of genetically modified foods (GMOs) and recombinant DNA technology. In 1979, the Prime Minister passed the Guidelines for Recombinant DNA Experiments for researchers to ensure the safety of recombinant DNA technology and its appropriate use. Since then, studies on the recombinant DNA have elucidated that an individual organism consists of an exquisite and harmonious combination of many genes, and that it is impossible to create a new organism by merely inserting some genes. Thus, the fear of creating organisms that have an unexpected and significant impact on human society and the global environment that arose in the early stage is nothing more than a fantasy. It also became clear that genetic recombination occurs frequently in nature due to genetic exchange between microorganisms. Such knowledge led to the establishment of a method to evaluate the harmfulness (pathogenicity, toxicity) in relation to the recipient organism (host) and the inserted recombinant gene (foreign DNA), and thus evaluate the safety of the resulting living modified organism (LMO). Moreover, if the DNA of living organisms that frequently exchange genes in the natural world is inserted into a host of the same species, it would not be employed in recombinant DNA experiments.

Meanwhile, LMOs, developed via recombinant DNA technology, have been used in many fields such as

the cultivation of genetically modified plants and breeding of genetically modified animals. The cultivation and import/export of genetically modified crops raise concerns over the impairment of wildlife's diversity in the natural environment. Consequently, the Cartagena Protocol on Biosafety has been adopted as an international measure. Domestically, the aforementioned guidelines were removed and replaced with the Act on the Conservation and Sustainable Use of Biological Diversity through Regulations on the Use of Living Modified Organisms (Cartagena Act) passed in 2004, and it is used until the present day.

2 Mechanism of the Regulation (Cartagena Act)

The Cartagena Act aims to ensure biodiversity through containment measures by regulating the use of LMOs and fused-cell organisms. The regulation applies to organisms that are obtained through genetic recombination between the organisms of different species or cell fusion between the organisms of different families. Humans are not regulated by the Cartagena Act, but by another law. When researchers plan to create or use LMOs, an application form that contains LMO information and creation/usage plan (a "protocol" in research and development) must be submitted in advance to the safety committee of the institution. The application could either receive a positive decision (Institutional Approval) on the verified safety and containment measures if they comply with the regulations set by the competent authority (MEXT for universities). If the application deviates from the provisions stipulated above, it will be transferred to the competent authority, and the genetic recombination committee will decide on the verified safety and containment measures (Minister Approval). Although the regulation scope does not include animal and plant cultured cells that do not grow outside the laboratory, the genetically modified organisms of animal and plant cultured cells must be handled in accordance with the conventional guidelines. (NUT considers such experiments subject to notification requirements.)

In the Cartagena Act, the creation and use of LMOs is classified into two types. (1) Type 1—LMO is used in environments without containment measures, such as cultivation in outdoor fields and utilizing for feeding. (2) Type 2—LMO is used in the environment with containment measures, such as laboratory, fermentation device, and breeding area. Type 1 use is rarely implemented at NUT; hence, we focus only on Type 2 use hereafter.

In accordance with the regulations, NUT has established the Nagaoka University of Technology Regulations for the Safe Management of Recombinant DNA Experiments and the Recombinant DNA Safety Committee to oversee the institutional safety. At the start of an experiment, the experiment manager (faculty) is required to specifically follow procedure (1) or (2), which are discussed below. While conducting the experiment, the experiment manager and all experiment personnel must comply with procedures (3)–(7).

- (1) The experiment manager must contact the recombinant DNA safety officer before starting the experiment (during the planning process), and create a protocol in the prescribed format. The protocol must receive written feedback on containment measures from the safety officer and signature stamps from both the safety officer and department head, after which it can be submitted to the Section of Research Support of Division of Industry-Academia Cooperation and

Research Promotion (hereafter referred “Section of RS”) (Figure 1). The Section of RS compiles the application forms submitted by the faculty member, and submits them to the Recombinant DNA Safety Committee. After the Section of RS receives safety confirmation from the committee, they notify each experiment manager of the institutional approval.

- (2) A safety confirmation from the Minister of Education is required for experimental approach that deviate from the scope of containment measures stipulated by the MEXT Ordinance. If the experimental procedures do not comply with the containment measures, the protocol must be rewritten at the direction of the safety officer to be applied for ministerial confirmation and then submitted to the Section of RS. The Section of RS submits the protocol to the MEXT following confirmation by the safety committee. MEXT's Expert Committee on Recombinant DNA Technology verifies the effective containment measures and notifies the university of the decision on the Minister’s confirmation. The Section of RS notifies the results to the experiment managers.

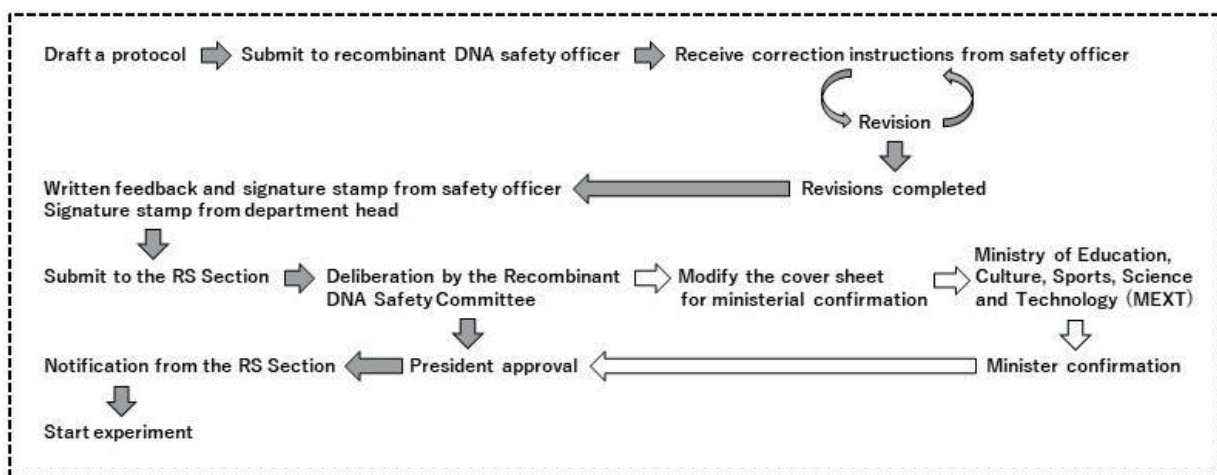

Figure 1 Application Procedure for genetic engineering (recombinant DNA) experiments

- (3) When performing the experiment, the experiment’s manager must take the necessary containment measures including appropriate equipment, methods, disposal and treatment processes, storage, management, and labeling. In addition, the experiment’s manager must inform all who work on the experiment of the protocol details and necessary containment measures.
- (4) The experimentalists must understand and follow the containment measures necessary to conduct the experiment.
- (5) Experimentalists must undergo training on the recombinant DNA experiment procedures and health examinations (may be substituted with general health examination).
- (6) The experiment manager must submit a list of the experimentalists for health examination at the beginning of the year and a progress report of the experiment at the end of the year to the Section of RS. As specified in the protocol, the experiment manager must submit a final report of the experiment when the experimental period expires and a cancellation report if the experiment had to be stopped. In addition, the experiment manager must implement measures for the storage and disposal of

genetically modified organisms and manage records.

- (7) Researchers must provide necessary containment measures, display, and information provision during the storage, transportation, and transfer in/out of LMOs.

3 Determination of Containment Measures

Containment measures for Type 2 LMO are implemented by combining physical and biological containment measures for the safety of the experiment. Physical containment is prioritized, but employing biological containment may mitigate the required extend of physical containment use.

Physical containment aims to prevent the spread of LMO into the environment by confining them to the facility or equipment. Physical containment consists of two factors—requirements of the containment facilities and compliance items for conducting the experiments. Three levels—P1, P2, and P3—are established for experiments using microorganisms based on the level of containment. "P" denotes the first letter of the word "physical," and higher numbers correspond to higher degrees of containment. Similar to the P1/P2/P3 scale used in the experiments with microorganisms, large-scale culturing experiments employ an LSC/LS1/LS2 scale, animal experiments use a P1A/P2A/P3A scale, and experiments on plants use a P1P/P2P/P3P scale.

Biological containment uses a safe host that cannot survive in the environment (certified host) or a "host vector system" that combines a safe host that cannot survive in the environment with a vector (specified certified host). The aim of biological containment is to prevent the spread of LMOs to the environment. The level of containment is divided into the following two sub-levels based on the safety level of the host vector system—certified (B1) and specified certified host vector systems (B2). "B" denotes the first letter of the word "biological," and higher numbers correspond to higher degrees of containment and safety.

The level of physical containment is determined based on the safety of the gene to be inserted (supplied nucleic acid), classification of the organism from which it is derived (nucleic acid donor), and classification of the organism receiving the gene (host) (Table 1). The list of organisms contains viruses; when a foreign gene is introduced into the virus, the virus itself becomes the host, rather than the cell that receives the virus. The specific experimental classification is based on the MEXT public notice, "Establishment of certified host vector systems based on the provisions of the Ministerial Ordinance for containment measures in the use of Type 2 Living Modified Organisms related to research and development." Organisms of Class 2 or higher are listed in Appendix Table 2; unlisted organisms fall under Class 1. Animals and plants fall under Class 1. The certified and specified certified host vector systems are listed in Appendix Table 1 of the MEXT notice. Because MEXT revises the public notice according to new scientific discoveries, it is desirable to download it from the website (listed in the reference at the end) at the time of use.

Table 1. Basis for experimental classification

Experimental category	Class 1	Class 2	Class 3	Class 4
Pathogenicity (1)	None	Low	High	High
Propagability (2)	—	—	Low	High

(1) Nature and extent to which it causes diseases to animals that belong to class Mammalia and Aves.

(2) Nature and degree at which nucleic acid transfers from one organism to another.

Table 2 shows the mechanism of determination considering the classification and safety of the supplied nucleic acid. For example, a P1 level is assigned when a gene derived from a Class 1 nucleic acid donor is introduced into a Class 1 host vector system. A P2 level is assigned when various genes derived from a Class 2 nucleic acid donor are introduced into a Class 1 host vector system without identification. However, a P1 level is assigned if the insertion is of genes derived from a Class 2 nucleic acid donor who is verified to be safe (identified/ safe nucleic acid). Further, a P2 level is assigned regardless of the safety of the gene, when a gene derived from a nucleic acid donor of Class 2 or lower is introduced into a Class 2 host vector system. When introducing various nucleic acids extracted from the environment into a Class 1 host vector system without identification, the highest experimental classification of the pathogenic microorganisms assumed in that environment is applied. However, a P1 level is assigned when the nucleic acid insertion is specifically amplified using the PCR (Polymerase Chain Reaction) method and identified as safe. The safety of the gene is determined through its lack of involvement in pathogenicity or toxin production.

Table 2. Determine of Containment Measures

Host	nucleic acid donor	supplied nucleic acid	Containment level	Determination mechanism
Certified host	1	Identified/safe	P1	Identified -> match host level
1	1	Identified/safe	P1	
1	2	Identified/safe	P1	
2	1	Identified/safe	P2	
3	1	Identified/safe	P3	Minister confirmation
1	1	Unidentified/unknown	P1	Unidentified -> match higher level
1	2	Unidentified/unknown	P2	
2	1	Unidentified/unknown	P2	
Specified certified host	2	Unidentified/unknown	P1	Eased containment level based on host
3	1	Unidentified/unknown	P3	Minister confirmation
1	1	Identified/pathogenic etc.	P2	Pathogenicity-> increase by one level
1	2	Identified/pathogenic etc.	P3	
	2	Identified/pathogenic	P1	Eased containment level based on host

4 Realities of Physical Containment

To specifically explain physical containment, the details of physical containment at P1 and P2 levels are shown below:

- (1) Physical containment at the P1 level necessitates the following requirements and compliance items:

Requirements for P1 level facilities

Details of containment measures		✓
1	The laboratory possesses a structure and equipment of a normal biological laboratory	

Compliance items for conducting recombinant DNA experiments

Details of containment measures		✓
1	For LMO-containing waste (including liquid waste), take measures to inactivate the LMO prior to disposal	
2	If LMOs are attached to equipment, devices, and tools, take appropriate measures to inactivate the LMO before disposal or reuse (clean equipment first if necessary)	
3	For the laboratory table, take measures to inactivate the LMO after completion of the experiment on the same day, and also immediately after LMOs attach	
4	Keep the laboratory door closed (except when entering and exiting the laboratory)	
5	Take important measures such as closing the laboratory windows to prevent entrance of insects.	
6	Minimize the generation of aerosols during all operations	
7	When taking LMOs out of the laboratory in the course of an experiment, ex. to inactivate LMOs outside the laboratory, the LMOs must be placed into a container with a leak-proof structure for physical containment	
8	Take necessary measures to prevent LMO attachment or infection, such as hand washing after handling	
9	Take measures to prevent the unnecessary entrance of visitors into the laboratory who are not familiar with the experiment details	

- (2) Physical containment at the P2 level necessitates the following requirements and compliance items, in addition to those required in the P1 level:

Requirements for P2 level facilities

Details of containment measures		✓
2	The laboratory is equipped with a biological safety cabinet for research (only when performing operations prone to release aerosols)	
3	A high-pressure sterilizer must be installed in the building where the laboratory is located, if it will be used to inactivate LMOs	

Compliance items for conducting recombinant DNA experiments

Details of containment measures		✓
10	A biological safety cabinet should be used for operations that are prone to releasing aerosol, and measures must be taken to inactivate LMOs attached to the safety cabinet following the end of the experiment on the same day and immediately after adherence of LMOs	
11	Indicate "P2 level experiment in progress" on the entrance of the laboratory and on equipment used to store LMOs while the experiment is in progress	
12	When experiments with containment levels of P1, P1A, or P1P are performed simultaneously in the same laboratory, the experiment areas should be clearly set. Otherwise, containment measures should be taken corresponding to containment levels P2, P2A, and P2P, respectively	

Reference

- Life Sciences Square of MEXT; Bioethics and Safety Initiatives: Genetic Modification Experiments
<http://www.lifescience.mext.go.jp/bioethics/anzen.html#kumikae>

Section 1 Introduction

1 What is Radiation?

Radiation is an electromagnetic wave or particle beam that has the ability to directly or indirectly ionize air and is designated by a Cabinet Order (Atomic Energy Basic Act, Article 3, Item 5; see Section 3). In addition, it is sometimes called the "ionizing radiation" due to the ionizing ability of the radiation (Article 2 of the Regulation on Prevention of Ionizing Radiation Hazards, Industrial Safety and Health Act).

Radiation is characterized by its ability to penetrate, ionize, and excite substances, and is widely used in medicine and research. Humans are unable to detect radiation using the five senses (sight, smell, taste, hearing, and touch); therefore, they can be **overexposed to radiation in the absence of adequate knowledge of radiation safety handling.**

The use of radiation emitted from radioisotopes and radiation generator may greatly contribute to research and industrial development, but there exist risks of being exposed to radiation, creating radiation hazards on the human body (See Section 2). This was revealed in an unfortunate critical accident that occurred at the Tokai Plant of JCO Co., Ltd. in Ibaraki Prefecture on September 30, 1999, which resulted in casualties due to widespread public radiation exposure.

As you know it is necessary to prevent accidents during research using radiation. However, to handle disaster management such as earthquakes or fire, **radiation workers must have a basic understanding of the characteristics of radiation, the differences between radiation and radioactivity, radiation detection methods, and radiation injury prevention methods.**

The Nagaoka University of Technology conducts experiments related to radiation only during the lectures on radiation-related experiments and safety, but those who wish to deepen their understanding may receive further education at the Radioisotope Research Center, Extreme Energy-Density Research Institute (EDI), and the Department of Nuclear Technology.

2 Where can it be used?

The Act on the Regulation of Radioisotopes (hereinafter referred to as the "RI Law") strictly regulates the locations where radioisotopes (RI) and Radiation generator can be used to prevent the damages caused by radiation exposure. In principle, these devices may not be used except in facilities created for the purpose of handling radioisotopes.

Japan's Nuclear Radiation Authority has approved Nagaoka University of Technology **for the use of radioisotopes at the Radioisotope Center and Radiation generators at the Extreme Energy-Density Research Institute (EDI) and Faculty Building for Nuclear System Safety Engineering and System Safety.**

The laboratory facilities and daily usage limit for each type of radioisotope are established by the RI Law; the usage location and usage frequency of the Radiation generators are also provided by this law. **When engaging in radiation-related studies, researchers must devise an experimental plan in advance, and make coordinated adjustments with other researchers so that the usage quantity and frequency are not exceeded.** These regulations ensure the safety of radiation workers and the public who reside outside the controlled area.

3 Who can use it?

At the Nagaoka University of Technology, radiation access is limited to the people who comply the following criteria: registered as a radiation worker as specified in the Nagaoka University of Technology Regulations on Radiation Injury Prevention (referred hereafter as “prevention regulations”); received the necessary education, training, and special health examinations; and received approval from the Nagaoka University of Technology Radiation Safety Committee (**radiation worker**, see Section 3).

4 What can use?

Only Japan’s Nuclear Radiation Authority approved type, quantity, and format of radioisotopes (both sealed and unsealed radioactive sources) and Radiation generator, whose list as per February 12, 2012, is given in Table 8-1, is used by the Nagaoka University of Technology.

Table 8-1 Radioisotopes and Radiation generator that can be used at the Nagaoka University of Technology

Radioisotope	Unsealed radioactive source	^3H , ^{10}Be , ^{14}C , ^{31}Si , ^{32}P , ^{35}S , ^{51}Cr , ^{55}Fe , ^{57}Co , ^{59}Fe , ^{85}Sr , ^{99}Tc , ^{106}Ru , ^{125}I , ^{129}I , ^{131}I , ^{133}Ba , ^{137}Cs , ^{139}Ce , ^{141}Ce , ^{144}Ce , ^{147}Nd , ^{152}Eu , ^{169}Yb , ^{237}Np , ^{241}Am , ^{242}Cm , ^{243}Cm , ^{243}Am , ^{244}Cm , ^{252}Cf (Purpose of use: Research on chemical reactions)
	Sealed radioactive source	^{57}Co 370MBq, ^{57}Co 740MBq, ^{60}Co 37MBq, ^{109}Cd 370MBq, ^{113}Sn 1.11GBq, ^{137}Cs 370MBq, ^{144}Ce 370MBq, ^{170}Tm 370MBq, ^{204}Tl 185MBq, ^{241}Am 370MBq, ^{252}Cf 18.5MBq (Purpose of use: Research on meters and instruments, and chemical reactions)
Radiation Generator	Cockcroft–Walton accelerator, 1 unit (Purpose of use: Basic experiments on the generation and application of high-intensity pulsed ion beams) Cockcroft–Walton accelerator, 1 unit (Purpose of use: Basic experiments on the generation and application of high-intensity electron beams) Cockcroft–Walton accelerator, 1 unit (Purpose of use: Material analysis and development using high-energy ion beams) Cockcroft–Walton accelerator, 1 unit (Purpose of use: Composition analysis by irradiating samples with an ion beam)	

Section 2 Effects of radiation on the human body

Humans are constantly exposed to tiny (traces) amounts of radiation in their regular environment. This radiation is called natural background radiation and includes radiation from cosmic rays, neutrons, uranium-238, thorium-232, radium-226, radon-222, and potassium-40. Although the amount varies slightly based on the region, the average radiation dose (effective dose) on the human body from the background radiation is approximately 2 millisieverts (mSv) per year. In addition, humans may be exposed to artificial radiation, primarily during medical treatments such as X-ray imaging. The National Institute of Radiological Sciences (NIRS-QST) has published on its website a quick view of the various radiation exposure we encounter in daily life (Figure 8-1: <https://www.qst.go.jp/uploaded/attachment/1572.pdf>).

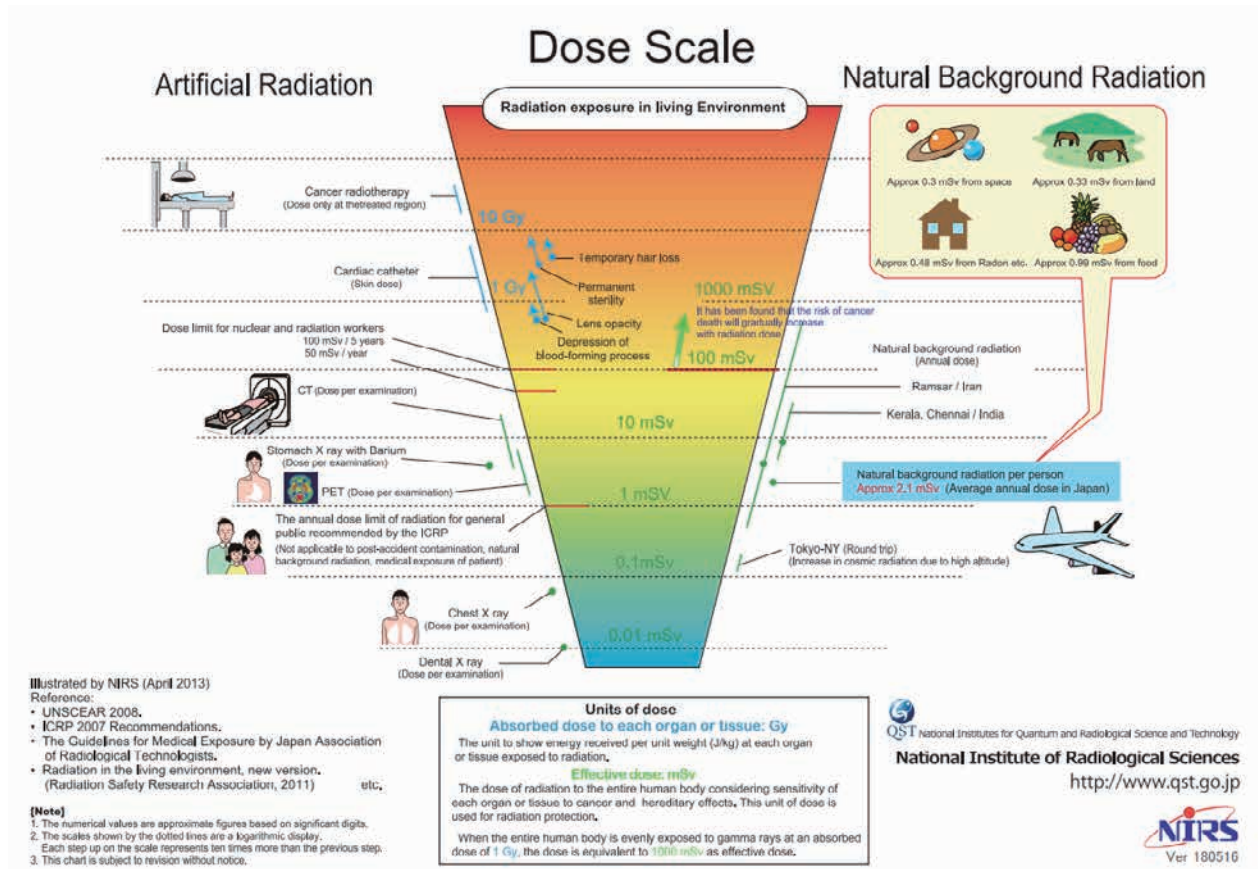

Figure 8-1 Relationship between daily life and radiation

The RI Law stipulates the limit for the effective dose of radiation on workers using radiation for research purposes as 100 mSv per 5 years and 50 mSv per year. This amount is approximately 10–25 times the dosage received from the background radiation.

Radiation is generally considered to cause injury to the human body. Damages develop on the atomic, molecular, cellular, tissue, organ, and individual levels with the advancement in exposure. In addition, some

radiation damage may affect the offspring.

This section describes the effects of radiation on the human body, and the differences in effect based on radiation dose and exposure method.

1 Categorization by timing of onset of radiation injury

Radiation injury can be broadly divided into two categories—**somatic** and **genetic effects**—based on to whom and when the impact occurs (Figure 8-2). Somatic effects appear in the individual exposed to the radiation, and can be categorized into acute effects, which appear immediately (2 to 3 months) after the exposure, and late (delayed) effects, which appear over a long period (from 10 months to several years) after the exposure. Genetic effects have not yet been confirmed in humans. It typically developed in not individuals exposed to the radiation but their children or grandchildren. The genetic mutation transmits to the descendants and express itself as a somatic effect in the offspring.

- Acute effects: Appears when one is exposed to a large amount of radiation in a short time. Radiation exposure to a wide area of the body causes symptoms such as fever, bleeding, decrease in leukocytes, diarrhea, vomiting, dehydration, skin erythema and ulcers, and hair loss.
- Late effects: The biggest concern is carcinogenesis. The main types of cancer caused by radiation exposure in humans are blood, skin, thyroid, breast, and bone tumors. Other diseases include cataracts.

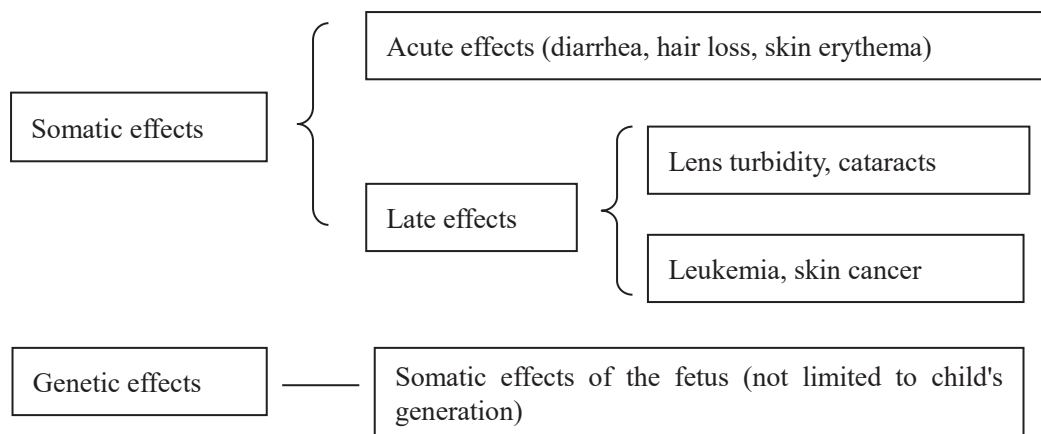

Figure 8-2 Somatic effects (acute effects/late effects) and genetic effects of radiation exposure

2 Categorization by mode of exposure

(1) External and internal radiation exposures

Radiation exposure is categorized based on whether the radiation source is inside or outside the body. **Internal exposure** occurs when the body is exposed to radiation from a radiation source inside the body, while **external exposure** occurs when the body is exposed to radiation from a source outside the body. The degree of radiation injury varies based on type of radiation. Internal exposure to alpha ray emitting radionuclides requires special attention as nearly all radioactive energy contributes to severe damages. Internal exposure causes constant radiation exposure until the radiation source is expelled outside the body. Internal exposure is evaluated using the biological half-life, or the time until the ingested radioisotope is excreted, and the effective half-life calculated from the physical half-life of the radioisotope.

Time, distance, and shielding measures minimize exposure to external radiation. Prevention of **inhalation, ingestion, and percutaneous absorption** is required to minimize internal exposure.

(2) Acute and chronic radiation exposures

Acute radiation exposure refers to exposure to a high dose of radiation in a very short period of time, and **chronic radiation exposure** refers to chronic or intermittent exposure to radiation over a long period of time. There may be differences in the degree of radiation injury between acute and chronic exposures, even if the exposure dose is the same. This is because the recovery power of cells and tissues to bounce back from damage exceeds the radiation damage. In the field of radiation protection, humans recover from low-dose radiation exposures measuring 0.1 Gy or less per hour in absorbed dose rate (Gy, or the radiation energy absorbed by tissue per unit time) without the development of radiation injury.

(3) Partial and total body radiation exposures

Partial body radiation exposure (localized radiation exposure) refers to the exposure of a part of the body, while total body radiation exposure refers to exposure to the entire body or a large part of the body. The effects develop differently depending on the exposure area and volume. For example, skin erythema may occur if the palm is exposed to 10 Gy, although recovery is possible. However, a total body exposure of 10 Gy might be fatal.

This occurs because, in a partial body exposure, only the tissues and organs exposed to the radiation are affected. However, in a total body exposure, the radiation effects start in tissues and organs with high radiosensitivity, then develop in all tissues and organs with the increase in radiation dose.

Table 8-2 shows the radiosensitivity of each tissue. Cells are most radiosensitive during the differentiation process, wherein undifferentiated fetal cells transform into specialized cells of adult tissue. Certain fetal cells are present and continue to differentiate in adulthood, such as those found in the bone marrow, lymph glands, epidermis, and reproductive glands; these cells have high radiosensitivity. **In other words, tissues and organs with active cell division and high metabolism have high radiosensitivity.** Hematopoietic

organs, lymphoid tissues, and reproductive glands are the most sensitive; particularly, root stem cells are highly radiosensitive. Moreover, blood vessels, skin, and cells of the central nervous system are moderately resistant, and muscle, bone, and peripheral nerves are highly resistant to radiation.

(4) Radiation exposure during pregnancy and effects on the fetus

Even non-regenerative cells in adult tissues are **highly sensitive as fetal tissues** because they undergo cell division during the development. Table 8-3 shows the effects of radiation on the fetus. Women who are pregnant or may be pregnant should take note of the radiation dosage to which they are exposed while handling radiation.

3 Categorization by threshold

The frequency and probability of radiation injury are related to the radiation dose. The minimum dose at which the effects of radiation appear is called the **threshold dose**. The International Commission on Radiological Protection (ICRP) categorizes radiation effects based on the presence of threshold as stochastic effects or harmful tissue reactions (Table 8-4 and Figure 8-3). The radiation dose limit for radiation workers is set by a policy to prevent the occurrence of harmful tissue reactions and limit the occurrence of stochastic effects to an acceptable level.

Table 8-2 Radiosensitivity of tissue

Radiosensitivity	Tissue
Highest	Lymphoid tissue (thymus, spleen), bone marrow, reproductive glands (testes, ovaries)
High	Small intestines, skin, capillaries, crystalline lens
Medium	Liver, salivary glands
Low	Thyroid, muscles, connective tissue
Lowest	Brain, bones, nerve cells

(Cited from *Hoshasen Gairon*)

Table 8-3 Radiation effects on fetus

Fetal period	Term	Radiation impact	Threshold <Gy>
Germinal stage	Fertilization until 8 days after fertilization	Embryo loss	0.1
Embryonic period	9 days to 8 weeks after fertilization	Congenital malformation	0.15
Fetal stage	8 weeks to 25 weeks after fertilization	Mental development retardation	0.2–0.4
	8 weeks to 40 weeks after fertilization	Fetal growth restriction	0.5–1.0
All terms	—	Cancer and genetic effects	—

(Cited from *Hoshasen Gairon*)

Table 8-4 Categorization of radiation effects from the perspective of radiation protection

Type	Goals of radiation protection	Threshold	Factors that change with increased radiation dosage	Example
Stochastic effects	Limit occurrence to an acceptable	Does not exist	Probability of occurrence (frequency)	Carcinogenesis Genetic effects
harmful tissue reactions	Prevent all occurrences	Exists	Severity	Cataracts, skin erythema, hair loss, infertility

(Cited from ICRP No. 26)

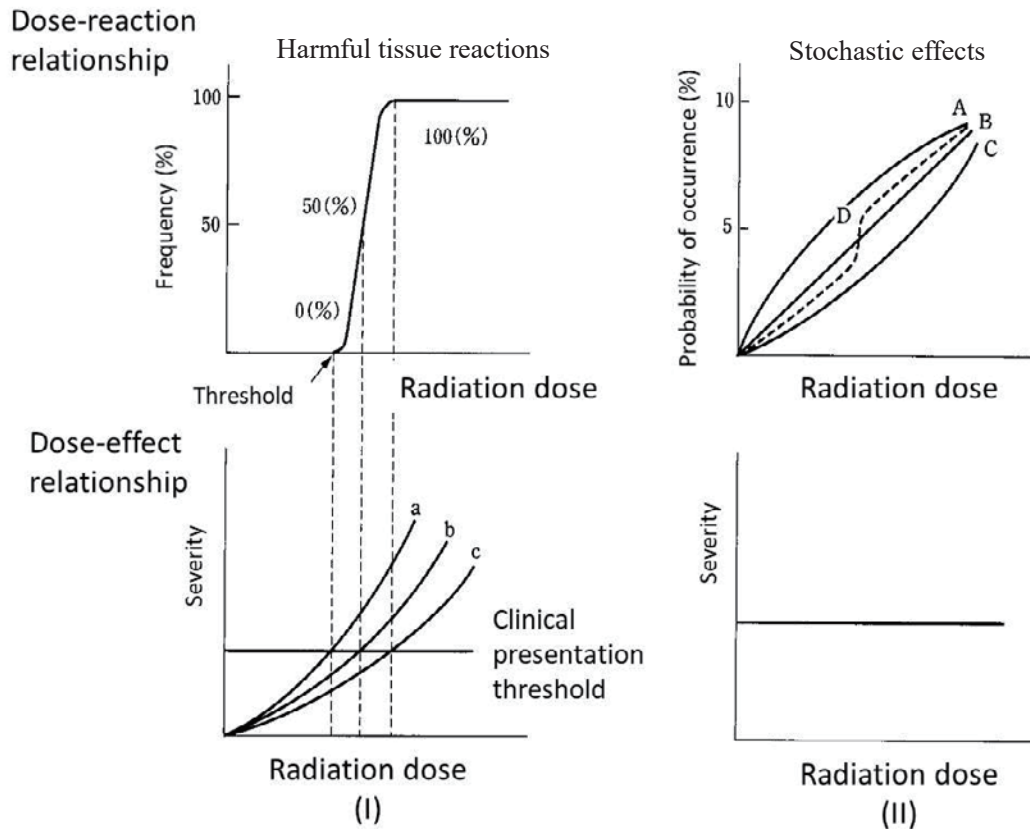

Figure 8-3 Relationship between radiation dose and radiation effects. Cited from the Foundations of Radiation Handling Safety)

4 Categorization by type of radiation

As radiation traverses an organism, the interaction of radiation with matter energizes the matter. As mentioned above, almost all radiation effects to the human body are considered injury. The degree of injury varies significantly according to type of radiation.

Linear energy transfer (LET) refers to the energy per unit distance that the radiation transfers to the substances along its path. Among radiations of the same energy, the LET is larger for alpha rays than beta rays or gamma rays. Generally, gamma rays (X-rays) and beta rays are considered to be **low-LET forms of radiation**, while neutron rays, alpha rays, proton beams, and heavy particle beams are **high-LET forms of radiation**.

Section 3 Radiation, RI, and radiation-emitting devices

1 Radiation

The RI Law is a law enacted to regulate the use of RI and Radiation generator and the disposal of RI-contaminated waste to prevent radiation damage and ensure public safety. **Radiation subject to regulation is "electromagnetic waves or particle rays that have the ability to ionize air directly or indirectly, as specified below."**

- (1) Alpha rays, heavy particle beam, proton beam, and other heavily-charged particle beam and beta rays
- (2) Neutron beam
- (3) Gamma rays and Characteristic X-ray (limited to characteristic X-rays generated by the orbital electron capture process)
- (4) Electron beams and X-rays with energies 1 MeV or more

Note) Electron beams and X-rays with energies less than 1 MeV are subject to the Regulation on Prevention of Ionizing Radiation Hazards, and still require radiation protection measures. For details, see "Chapter 9: X-rays and X-ray generators."

Below, we briefly describe the interaction between substances and typical radiation (alpha rays, beta rays, gamma rays (X-ray), and neutron beam).

1. Alpha rays

Alpha rays consist of two protons and two neutrons bound together into a particle identical to a helium nucleus. As this is heavier particle than the beta rays, which is similarly electrically charged, they travel in nearly straight paths and has minimal bremsstrahlung losses caused by electron interaction. The specific ionization increases with the decrease in velocity, reaching maximum energy of 370 keV before it stops. **The thickness of the medium through which the radiation can penetrate (range) varies by the type of particle, its original energy of motion (kinetic energy), and the medium through which it travels. The range of alpha rays emitted from an ordinary radioisotope is only a few centimeters in the air.** Due to the short range, one sheet of paper is sufficient to shield alpha rays, and the risk of external exposure is extremely low. However, when alpha-ray-releasing nuclides are taken inside the body, the particle can release enormous energy to a narrow region in the living cells. The range of alpha rays in a living body, at several dozen μm , is shorter than that in the air. However, there is a risk of serious local damage. For these reasons, **the inhalation, ingestion, or absorption of alpha-ray-releasing nuclides into the body is extremely dangerous, and strict measures for safety management are taken.**

2. Beta rays

Beta rays is an electron beam emitted from the atomic nucleus. Beta rays includes β^+ (producing positrons) and β^- decays (producing electrons); both rays release same charged particles that differ in their sign. The primary interaction of beta rays and matter are (1) excitation and ionization of atoms by Coulomb force and (2) **braking X-ray (bremsstrahlung) generation** through interaction with atomic nuclei. A positron that loses energy due to its interaction with matter undergoes a **pair annihilation** with an electron and produces two photons. In addition, beta rays also undergo **backscattering**, where the particles undergo excitation, ionization, and scattering, and exit from the same direction as it entered. Hence, shielding measures must be taken for the scattered rays.

When selecting a shielding measure for beta rays, the bremsstrahlung X-ray radiation must be considered. **A suitable method would be to shield the high-energy beta rays using a substance with a small atomic number (such as acrylic or aluminum), and shield the bremsstrahlung X-rays with iron or lead.**

3. Gamma rays (X-ray)

Gamma rays are photons emitted when a nucleus transitions from an excited energetic state to a lower-energy state. As photons have no electric charge, their interaction when passing through matter is different from that of charged particles, such as alpha and beta rays. Interactions of photons with matter include Thomson scattering, photoelectric effect, Compton effect, and electron-positron pair production.

The difference between gamma rays and X-rays stems from the generation process. In gamma rays, rest energy is given off as photons through a nuclear reaction or elementary particle reaction, while X-rays are produced when the extra energy generated by charged particles as they change from motion to restricted states is emitted as photons. These rays are not classified by photon energy.

Shielding measures for gamma rays include the use of an appropriate substance corresponding to the photon energy. In general, lead or a similar substance is suitable for radiation shielding as gamma rays (X-rays) have large interaction with high-density materials.

4. Neutron beam

Neutrons are electrically neutral particles. They are unstable particles with a half-life of ten and several minutes; when they decay into a proton and electron, interactions occur similar to beta rays and alpha rays described previously. In addition, the interactions of neutrons with matter include a) elastic scattering, b) inelastic scattering, c) charged particle emission reaction, d) capture reaction, and e) nuclear fission. In an elastic scattering, neutrons lose more energy when they collide with smaller atomic nuclei. Therefore, **substances such as paraffin, concrete, and water, which contain several hydrogen atoms, are suitable to shield neutrons.**

In b)–e) effects, the interactions may cause the atomic nucleus to emit protons and γ -rays, or fission may occur in heavy atomic nuclei such as uranium. Such interactions also need to be considered for neutron shielding.

2 RI (Radio Isotope: Radioactive Isotopes)

The radioisotopes regulated by the RI Law are **isotopes that release radiation (such as phosphorus-32 and cobalt-60), its compounds, and their inclusions (including those equipped in the devices). RI Law regulates the quantity and concentration of radiation-emitting isotopes used in experiments when they exceed the quantity (lower limit) and concentration specified for each type by Japan's Nuclear Radiation Authority (Table 8-5).**

Table 8-5 Sample quantity and concentrations of radioactive isotopes

Column 1		Column 2	Column 3
Isotopes that release radiation		Quantity (Bq)	Concentration (Bq/g)
Nuclide	Chemical form		
³ H		1×10^9	1×10^6
⁷ Be		1×10^7	1×10^3
¹⁰ Be		1×10^6	1×10^4
¹¹ C	Monoxides and dioxides	1×10^9	1×10^1
¹¹ C	Not monoxide or dioxide	1×10^6	1×10^1

However, the regulation scope of the RI Law excludes items 1–5 below.

1. Nuclear fuel and source materials specified by the Atomic Energy Basic Act.
2. Pharmaceuticals and raw materials or ingredients specified in the Act on Securing Quality, Efficacy and Safety of Products Including Pharmaceuticals and Medical Devices that are present at manufacturing plants approved by this Act.
3. Drugs specified in the Act on Securing Quality, Efficacy and Safety of Products Including Pharmaceuticals and Medical Devices used in clinical trials at hospitals or clinics regulated by the Medical Care Act.
4. In addition to the above, drugs used by positron radio tomography equipment for image diagnosis or other drugs administered to persons receiving medical treatment or diagnosis, which are prepared at the hospitals performing the diagnosis or treatment, specified by the Nuclear Radiation Authority in consultation with the Minister of Health, Labour and Welfare.
5. Components equipped in the medical devices specified in the Act on Securing Quality, Efficacy and Safety of Products Including Pharmaceuticals and Medical Devices and the Nuclear Radiation Authority in consultation with the Minister of Health, Labour and Welfare or the Minister of Agriculture, Forestry and Fisheries.

3 Radiation Generator

The Radiation generator regulated by the RI Law are devices, such as cyclotron and synchrotron, that generate radiation by accelerating charged particles; these are listed as follows (devices whose maximum dose equivalent rate at a position of 10 cm from the surface is less than the dose equivalent rate set by the Nuclear Radiation Authority are excluded):

- (1) Cyclotron
- (2) Synchrotron
- (3) Synchrocyclotron
- (4) Linear particle accelerator
- (5) Betatron
- (6) Van de Graaff accelerator
- (7) Cockcroft–Walton accelerator
- (8) Other devices that generate radiation by accelerating charged particles and designated by the Japan's Nuclear Radiation Authority as necessary to take precaution against radiation damage.

4 Units of radiation

(1) Radioactivity

We often hear of “radioactivity” to indicate units of radiation. Radioactivity refers to the number of atoms decayed by the atomic nuclei of a radioactive isotope in a unit time, and one becquerel is defined as one atomic disintegration per second ($\text{Bq} = \text{s}^{-1}$).

Radioactivity describes traits, similar to speed or brightness, and does not directly identify the radioisotope or radioactive particles themselves. Media may use expressions such as "radioactivity leakage from nuclear power plants," but one must take care not to confuse radioisotopes, radiation, and radioactivity.

Prior to the becquerel (Bq), an older unit, Curie (Ci) was used to represent radioactivity, and measured the number of decays that occur in 1 gram of radium per second. One curie (1 Ci) is equal to 3.7×10^{10} Bq (radioactive decays per second).

(2) Radiation Dose

An absorbed dose measures the energy deposited by ionizing radiation in a unit mass of matter (1 kg) being irradiated, and is expressed as Gray (symbol: Gy; equal to joules per kilogram, J/kg).

The effect of radiation on the human body depends on the LET of the radiation. Radiation doses were devised to calculate the effects of various types of radiation on the human body on the same scale and to enable comparisons and combinations for the purpose of radiation protection.

$$\text{Radiation dose} = \text{absorbed dose} \times \text{radiation quality coefficient} \times \text{correction coefficient}$$

The radiation dose is determined for radiation protection, and the unit of radiation dose is Sievert (symbol: Sv, equal to joule per kilogram, J/kg).

Furthermore, equivalent doses are calculated considering differences in radio sensitivity of human tissues, and the effective dose is calculated by adding them.

(3) Electron volt

Radiation, as defined by the RI Law, includes "electron beams and X-rays with energies of 1 MeV or more." An eV is the measure of an amount of kinetic energy gained by a single electron accelerating from rest through an electric potential difference of one volt in vacuum, and is expressed as,

$$1 \text{ eV} = 1.602 \times 10^{-19} \text{ J}$$

1 MeV is equivalent to 1 million electron volts.

Section 4 Safety handling and usage procedures for RI and Radiation Generator

1 Safety handling

This serves as a handbook to explain the Nagaoka University of Technology Regulations on Radiation injury Prevention (prevention regulations) and the educational/training textbooks developed for the safe handling of RI and Radiation generator.

Prior to registration as a radiation worker, health examination and education/training are required for authorization to use RIs and Radiation generators. During use, radiation workers are obligated to maintain strict control of the radioactive source and record its receipt, delivery, usage, storage, transportation, and disposal. To prevent contamination and exposure, radiation workers must conduct an inspection of the equipment, work area, and floor surface before and after experiments, and measure the air-radiation dose rate during the experiment.

2 Usage procedures

To handle RIs and Radiation generator, one must register as a radiation worker specified in the prevention regulations.

The President will register the radiation workers pending a discussion with the Radiation Safety Committee and based on the results of the health examination and education/training. After registration, the radiation worker must perform a monthly measurement of radiation doses (using a "glass badge" radiation monitor) and undergo a health examination every six months or less.

3 Obtaining RI

RI procurement (for example, through purchase) requires permission from the chief radiation protection officer; hence, the purchase application form must be submitted to the Radioisotope Center Management Office.

RI may not be purchased or received without approval from the chief radiation protection officer. If the RI is received after the application is submitted, the Radioisotope Center Management & Calculation Office will verify the application and notify the applicant. The applicant must obtain the radioisotope label and recording sheet from the Management & Calculation Office before using the RI.

Please note that, under the RI Law, the radiation worker is considered to be in possession of the RI even if the content of the container is used up and the radioactivity is almost completely attenuated; thus, recording obligations continue until the disposal process is complete. Delivery or disposal procedures are desirable for RIs that are not intended for long-term use.

4 Education and training

To ensure the safe handling of RIs and Radiation generators, radiation workers who have access to controlled areas must undergo **education** and **training** in each period (not exceeding one year) to prevent radiation injury. **Radiation workers and new registrants will be notified about education and training sessions and must attend them.**

5 Entry and precautions in Radiation Facilities

Radiation workers must be familiar with the prevention regulations and consider the following (1) through (7) when engaging in radiation work at facilities where radiation is used. **Tours** must be conducted by first obtaining permission from the radiation safety officer, undergoing education and training for a temporary visitor, and under the guidance of a radiation worker. **Please note that the temporary visitor cannot operate or handle radioactive materials or radiation.**

- (1) Read the list of precautions posted in the radiation facility.
- (2) Eating, drinking, smoking, and make-up are prohibited in the controlled area.
- (3) Don't bring unnecessary items into the controlled area. In particular, wireless devices such as mobile phones must be turned off, as they may interfere with the functions of the personal radiation dosimeter.
- (4) In the contamination inspection room, **change into special slippers and wear a yellow lab coat.**
- (5) The **personal radiation dosimeter (Figure 8-4)** measures the radiation dose in the controlled area. **Men should wear the dosimeter on the chest and women on the abdomen.** Please roll up or lift the hem of any clothing that comes into contact with the floor.
- (6) Articles inside the controlled area may only be removed if the RI surface contamination has been measured and confirmed to be less than one-tenth of the surface density limit.
- (7) Before leaving the controlled area, hands, feet, and clothing must be inspected for contamination using the equipment (Figure 8-5). If contamination is detected, please seek instructions from the radiation safety

officer or radiation workers and perform appropriate decontamination.



Figure 8-4 Personal radiation dosimeter



Figure 8-5 Contamination detecting equipment for hands, feet, and clothing (hand-foot-clothing contamination monitor, HFC)

6 Detection of radiation

When inspecting the contamination of the equipment and work area and measuring the air-radiation dose rate during the experiment, it is necessary to select equipment that is well suited to the radiation used.

Commonly used radiation measuring devices include a portable ion chamber, NaI scintillation, and GM survey meters.

Because a survey meter may not detect alpha and soft beta rays (beta rays with weak energy), it is advisable to use the smear method to inspect and measure contamination on the equipment and work area caused by radiation-emitting nuclei. Commonly used measuring devices include a liquid scintillation counter or gas flow meter.

Further, a NaI (Tl) detector or a Ge detector is used to identify the radioisotope of the contaminated part. Figure 8-6 shows the Cobalt-60 (^{60}Co) spectrum made by the germanium-based semiconductor detector and wave height

analysis system (main photon energy and emission ratio of 1.173 MeV-100%, 1.333 MeV-100%; from *Radioisotope Pocket Data Book*).

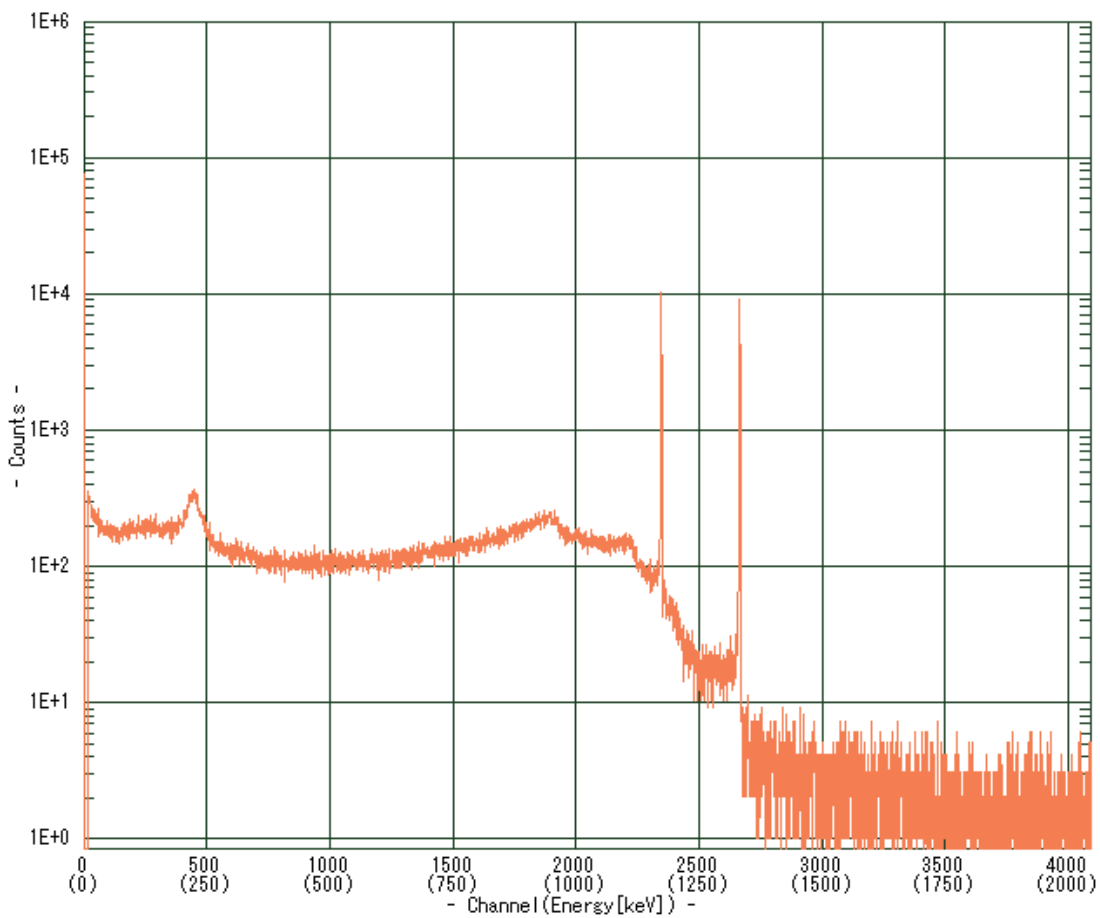

Figure 8-6 Cobalt-60 (^{60}Co) spectrum

(Measured using a semiconductor radiation detector and wave height analysis system)

7 Radiation protection

Basic measures for radiation protection include the following:

- Set an experimental plan and conduct sufficient preliminary experiments (cold run)
- Prevent external exposure
- Prevent internal exposure
- Do not work alone
- Perform contamination inspection before and after tasks and dosimetry during the tasks

Among these protection methods, we describe the prevention of external exposure and internal exposure below.

(1) Prevention of external exposure

There are three principles to prevent external radiation exposure—**shielding measures, distance, and time.**

A) Protection using shielding measures

The distance by which radiation permeates through matter differs according to radiation type and energy. Thus, shielding measures must be used to reduce radiation dosage maximally.

Because beta rays emits braking (bremsstrahlung) X-rays, it must be shielded with an acrylic plate.

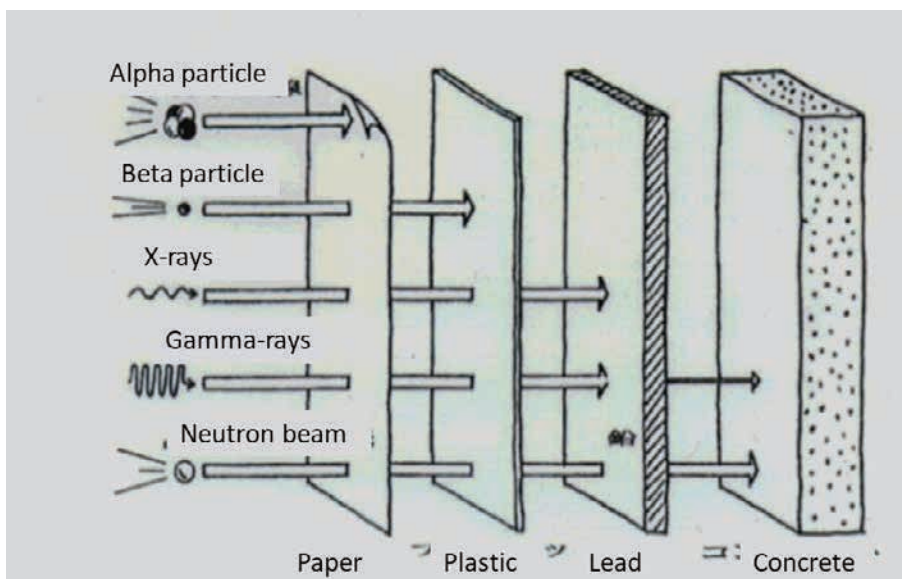

Figure 8-7 An example of shielding by radiation

B) Protection through distance measures

Because the radiation intensity is inversely proportional to the square of the distance, the radiation dose decreases sharply as the distance increases from the radiation source. Tongs with a long-handle or tweezers can be used to maintain the distance while handling RIs.

C) Protection through time measures

The radiation dose increases with the exposure time. Thus, the working time should be shortened by creating an experiment plan and by conducting sufficient preliminary experiments (cold run).

(2) Prevention of internal exposure

To prevent internal radiation exposure, one must take care of the three pathways—**oral, airway, and skin.** Although dependent on the chemical and physical properties, the following measures can be used to prevent radioisotopes from entering the body through these pathways. Rubber gloves should be worn to prevent RI from entering the body through the skin or wounds. RI should be handled inside a fume hood or draft chamber to prevent radiation from entering the body by inhalation. Safety bulb pipette fillers should be used to prevent accidental ingestion of RI reagents. **In the controlled area, actions that risk accidental intake of radioisotopes should be avoided, such as eating, drinking, smoking, or applying makeup.**

8 Handling of uranium, thorium, etc.

To ensure that nuclear material is used only for peaceful purposes and not for nuclear weapons, **it is necessary to designate a location to use/store several grams of nuclear material, accurately manage current inventory levels, and control its increase/decrease caused by the transfer in/out to the area over a set period.**

Nuclear fuel materials (materials that release high energy during nuclear fission such as uranium and thorium) and nuclear source materials (raw materials for uranium ore, thorium ore, and other nuclear fuel) are specified in the Atomic Energy Basic Act; thus, they are excluded from the RI Law. They are regulated by the Act on the Regulation of Nuclear Source Material, Nuclear Fuel Material, and Reactors, and it is necessary to obtain permission for their use. However, as shown in Table 8-6, permission is not required for the use of nuclear fuel materials in the range of types and within the quantities specified in Article 39 of the Order for Enforcement of the Act on the Regulation of Nuclear Source Material, Nuclear Fuel Material, and Reactors.

Table 8-6 Types and quantities of nuclear fuel material that do not require permission for use
(From the Nuclear Radiation Authority website)

	Type	Quantity permitted for use without further approval
(I)	Uranium and its compounds where the ratio of uranium-235 to uranium-238 is the natural mixing ratio.	Less than 300 grams of uranium
(II)	Uranium and its compounds where the ratio of uranium-235 to uranium-238 is below the natural mixing ratio.	Less than 300 grams of uranium
(III)	A substance containing more than 1-2 types of (I) and (II) and can be used as fuel in a nuclear reactor.	Less than 300 grams of uranium
(IV)	Thorium and thorium compounds.	Less than 900 grams of thorium
(V)	A substance containing more than 1-2 types of (IV) and can be used as fuel in a nuclear reactor.	Less than 900 grams of thorium

The following materials require usage approval regardless of quantity:

1. Uranium and its compounds where the isotopic ratio of uranium-235 to uranium-238 exceeds the natural abundance ratio
2. Plutonium and plutonium compounds
3. Uranium derived from Uranium-233 and its compounds

9 Equipment for Nuclear Safety Education at Nagaoka University of Technology and Examples of Experiments

The following equipment is stored at the Radioisotope Center at the Nagaoka University of Technology for nuclear safety education. The use of these devices provides an opportunity to acquire basic knowledge about radiation. Below, we list the equipment that can be used at the Nagaoka University of Technology, and in the next page we give examples of experiments that utilize the equipment.

- Basic scaler, Aloka (Hitachi), TDC-105, 1 unit
- GM tube, Aloka (Hitachi), GM-5004, 1 unit
- Measuring table, Aloka (Hitachi), PS-202, 1 unit
- β -chan, Chiyoda Technol Corporation, 5 units, includes lead, iron, and acrylic plates
- Scintillation survey meter, Aloka (Hitachi), TCS-171, 5 units, includes checking source (^{137}Cs)
- Lead blocks, PBBLOCK2B, 10 units, radiation shielding material
- Low-temperature diffusion cloud chamber, Shimadzu, WH-50, 1 unit, includes alpha ray source (^{241}Am)
- CCD camera for the low-temperature diffusion cloud chamber, 1 unit

A. Observe Invisible Radiation

Experiment objectives:

Radiation cannot be felt using the five senses. Hence, the objective is to observe the actual radiation emission through experiments using a cloud chamber.

Learning objectives:

Radiation is released radially from the radioactive source (Figure 8-8). Alpha rays have a short range and possess weak energy to penetrate matter. They can be shielded completely with paper, but they also pose a risk as they can pass all their energy to matter.

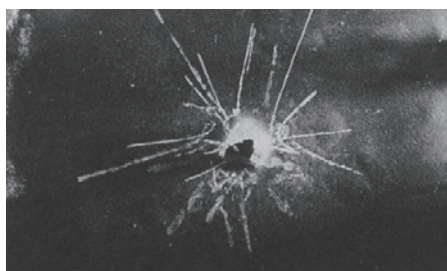

Figure 8-8 Flight path of alpha rays

Materials:

Low-temperature diffusion cloud chamber, ice, ice water container, ice water circulation pump and hose, ethanol (10 ml), pipette (1 unit), beaker (50 ml), paper cap (to shield α -radiation, handmade), CCD camera, camera support base (clamp or tripod), monitor (use from laboratories of each network), and camera-monitor connection cable.

Experimental Procedure: When using a low-temperature diffusion cloud chamber,

1. Set the low-temperature diffusion cloud chamber, CCD camera, monitor, ice water, and circulation pump.
2. Take out the alpha ray source for the cloud chamber to let students confirm that the radiation from the radiation emission slit is invisible.
3. Soak the felt in the cloud chamber with ethanol, attach the alpha ray source to the cloud chamber, and turn on the power for the cloud chamber and ice water circulation pump.
4. When radiation tracks can be seen in the cloud chamber window, set the CCD camera and monitor and let the students observe.
5. Explain the emission process and properties of the α -particle. Discuss the selection of the shielding material. Take out the alpha ray source from the cloud chamber.
6. Attach a paper cap to the tip of the alpha ray source and put it back in the cloud chamber.
7. After a while when radiation tracks can be seen in the cloud chamber window, let students observe that alpha rays can be shielded with paper, and discuss the experiment.

B. Radiation Safety Management

Experiment objectives:

Use a gamma radiation source (checking source) and scintillation survey meter to verify radiation shielding and changes in count number by distance, and learn safety management when handling radiation by applying protection measures of time, shielding, and distance.

Learning objectives:

Learn about the properties of the gamma radiation source (strong ability to penetrate matter) and selection of shielding material. Learn about the methods for the safe use of radioisotopes: the distance from the radiation source, shielding placed in the path of the radioisotope, and time spent handling the radiation source.

Materials:

Scintillation survey meter, checking source, and lead blocks.

Experimental Procedure:

1. Press the power button of the scintillation survey meter so that it is ready to take measurements.
2. Place the scintillation survey meter in a suitable location and record the measured values in the absence of a radiation source. Assume the time constant is 30 s. The value is best recorded after 90 s or more. Set this as the background value, A_{BKG} .
3. Next, measure the checking source. The net value obtained by subtracting A_{BKG} from the measured value becomes the value derived from the radiation source.
4. Verify the shielding effect of the lead block from the changes in measured value when the lead block is placed between the checking source and survey meter.
5. Confirm the effects of the distance from the radiation source through changes in measured value when the distance between the checking source and scintillation survey meter is extended to 2, 3, and 4 times. The experiment confirmed a relationship between the distance from the radioisotope and radiation exposure dose (the inverse square law), but did not observe proportional reduction as per the theory because a point source was not used.

C. Observation of background radiation

Experiment objectives:

Confirm that some substances existing in the natural world contain radioisotopes. Learn about the background radiation and its annual radiation dose.

Learning objectives:

Study the presence of background radiation and properties of beta rays (such as that from potassium fertilizer).

Materials:

Measurement experiment kit including β -chan

Experimental Procedure:

1. Check the power supply of the β -chan measuring device, and measure the radiation of each sample in the experiment kit (granite: 80–100 cpm; dried kelp: 100–120 cpm; potash (potassium chloride) fertilizer: approximately 10x background radiation; Potassium phosphoric acid fertilizer: lower than potash; geyselite: approximately 20x background radiation; crystal glass: 60–80 cpm)
2. Insert lead, iron, and acrylic plates between the measurement sample and β -chan to verify the shielding effects.
3. Increase the distance between the measurement sample and β -chan by 2, 3, and 4 times; verify the decrease in count number; and confirm the significance of taking distance measures for radiation safety.

In addition, other educational resources on nuclear safety are available, such as experiments on the half-life of radioisotopes and effects of shielding material thickness (Geiger/GM counter) and nuclide identification by radioisotope measurement and analysis (pulse-height spectrometry system).

Bibliography

1. Japan Radioisotope Association, *A Simple Guide to the Safe Handling of Radiation and Isotopes* (2018)
2. Nishizawa, Kunihide, ed., *The Basics of Radiation Safety and Handling*, The University of Nagoya Press (2013)
3. Tada, Junichiro. *Introduction to Radiation Physics*, Ohmsha (2018)
4. Shibata, Tokushi, ed., *Introduction to Radiation*, Trade Industry Research (2018)
5. Japan Radioisotope Association, *Radioisotope Pocket Data Book*.
6. Japan Radioisotope Association, *Isotope Law Collection* (I).

Devices that generate X-rays, e.g., X-ray diffractometers and fluorescent X-ray analyzers (henceforth collectively referred to as “X-ray-generators”), have a risk of radiation hazards to human bodies. The “Nagaoka University of Technology Regulations for the Prevention and Control of X-Ray Hazards” has been established in accordance with the Industrial Safety and Health Act and Regulations for Prevention of Ionizing Radiation Hazards. Staff members who handle X-ray devices and need to enter the controlled area as part of their duties should apply for registration and seek permission from relevant authorities to engage in such types of work. Regulations are in place to prevent radiation hazards in the same manner as followed for RI and radiation-generating devices.

Section 1 X-rays

1 X-ray management

X-ray is an electromagnetic wave with a wavelength of 0.01–100 Å. It is harmful to the human body owing to its ionizing effect, and utmost care should be taken while handling such waves to avoid radiation exposure. In a normal X-ray tube, which generates X-rays by irradiating high-energy electron beams on the cathode metal, the generated X-rays have a superimposed spectrum of a continuous spectrum by *bremsstrahlung* with the maximum energy at the acceleration voltage (tube voltage) and an average energy of approximately 1/3 of acceleration voltage, and the energy of characteristic X-rays specific to the cathode metal. In addition, the energy diffracted X-rays are sometimes used. Since the energy of X-rays are ~100 kV at highest, the radiation shielding is relatively easy to be achieved. However, it should be carefully shielded considering the effects of leakage and scattering from gaps, since the intensity is high. Moreover, as X-rays are generated when electrons are irradiated, commercially available X-ray generators have interlock mechanisms that operate with various shielding and safety mechanisms (e.g., shielding covers) to avoid exposing radiation to users. Therefore, users should be familiar with the use of X-ray generators and their mechanisms to conduct experiments. X-ray generators are radiation managerially classified into two types; one is a type that the radiation control area is only inside devices, and the other type is that the control area is required outside the devices. This classification depends on the structure of shielding, dose of X-rays leaking outside, and presence or absence of interlocks. The conditions for application and permission for use are different for each type. In summary, it is required to understand the mechanism and the characteristics of your using X-ray generator.

2 X-ray measurements

For X-ray detection, photographic method, fluorescence, and ionizing properties are used. Typical methods are listed in Table 9-1.

Table 9-1 X-ray measurement methods

Photographic method	X-ray films and dry plates
Counter tube method	Scintillation counters Geiger–Mueller counters and proportional counters Semiconductor detectors

The portable counter tubes (survey meters) are generally used to confirm which X-ray shielding is sufficient, although photographic methods can be used. Low-energy X-rays are difficult to detect by using ordinary radiation detectors. An effective measurement method should be selected to detect depending on the energy of X-rays.

3 Effects of X-rays on the human body

In the case of X-rays, the external exposure is dominant. The influence of X-ray is similar to dose of other radiation, and they damage the hematopoietic organs, gonads, eyes, and skin. For example, the radiation dose of X-ray that causes cataracts in the eyes is clinically estimated to be over 5 Sv.

Section 2 X-ray-Generators

The university is required to notify the Division of Industry-Academia Cooperation and Research Promotion when it intends to establish, expand, renovate, abolish, or change X-ray generators. When a room for the installation of X-ray generators is set up and is a controlled area, the X-ray facility manager is appointed, and X-ray equipment use manager is appointed for devices whose controlled area covers the inside of the device. In addition, staff members and others who use X-ray generators (here, “others” refer to students, co-users, and others who are not staff members of the university) and employees whose duties require them to enter the controlled area should register themselves in advance using the prescribed form and obtain approval from the president of the university. Employees and others who use X-ray equipment in a controlled area, or whose duties require them to enter such a controlled area, should be registered as X-ray workers, and those who use equipment in a controlled area covering the inside of the equipment should be registered as X-ray equipment users. The application will be automatically renewed until the applicants leave the university owing to retirement or graduation.

The registration of X-ray workers will be approved by the president based on the discussion among the Radiation Safety Committee according the results of medical examination, education, and training. After

registration, the individuals must undergo radiation dosimetry and medical examinations once every 6 months. Education and training after registration shall be conducted when there are changes in the trends of occupational accidents, socioeconomic conditions, and environments in the university. However, students should attend training after registration and when continuing their studies.

The registration of X-ray equipment users will be approved by the president based on the discussion among the Radiation Safety Committee according to the results of education and training. After registration, the individuals must undergo radiation dosimetry and medical examinations once every 6 months. Education and training after registration shall be conducted when there are changes in the trends of occupational accidents, socioeconomic conditions, and environments in the university. However, students should attend training after registration and when continuing their studies.

X-ray facility manager and X-ray equipment use manager should receive education and training every year. The education and training should be used to reduce the radiation exposure of the personnel working in the facility or the personnel using the equipment.

The following precautions should be taken while using X-ray generators:

1 Precautions when using X-ray-generators

While using an X-ray generator whose installation room is a controlled area, or the controlled area needs to be accessed frequently, radiation exposure should be checked by the person in charge using a glass badge, a pocket dosimeter, or other radiation measuring devices. The user must be familiar with the functions and mechanisms of the device and must carefully handle it to minimize exposure to radiation. Utmost care should be taken while removing or modifying individual components. Any changes observed in the device must be notified in advance. The user should carefully adjust the device to avoid exposing fingers, arms, and other parts of the body to radiation. Ring-shaped dosimeters, which can be worn on the fingers, can be additionally used to check the exposure to radiation.

The X-ray generators, in which only the inside of the device is set as a controlled area, includes safety components, e.g., interlocks, installed on each part of the device to prevent X-ray exposure. Therefore, there is very little risk of X-ray exposure during normal use. However, the user must be familiar with the mechanism in advance and must carefully handle the device. Certainly, each component must not be inadvertently removed or altered. The device should be carefully adjusted as it is easy to expose fingers and arms to radiation. Ring-shaped dosimeters, which can be worn on the fingers, can be additionally used to check the exposure to radiation.

X-ray generators must be inspected annually to ensure safety.

While using X-ray generators, please refer to the university's Regulations on the Prevention and Control of X-Ray Hazards for details. Moreover, it is recommended to refer to the Regulations for the Prevention of Ionizing Radiation Hazards at <https://elaws.e-gov.go.jp/document?lawid=347M50002000041>. In

addition, one can apply for the X-ray work chief license, which can be obtained by passing an examination. With this license, one can become the X-ray work chief. Students who are conducting research using X-rays are encouraged to take the examination, as it may be a useful qualification in the future.

Article 50 of the Ordinance on Prevention of Ionizing Radiation Hazards states that the examination to obtain the X-ray work chief license should be conducted based on the following subjects:

- 1 Knowledge on X-ray management
- 2 Knowledge of X-ray measurement
- 3 Knowledge of the effects of X-rays on the human body
- 4 Knowledge of relevant laws and regulations

A person who holds a Type 1 Radiation Protection Supervisor License is also eligible to become the X-ray work chief. A Type 1 Radiation Protection Supervisor License can be obtained by passing an examination and then undergoing training. The cost of the training is relatively high; however, there is no time limit between passing the exam and receiving the training; thus, it is possible to receive the training after employment and take the exam. If you can secure funding, taking the exam to obtain the Type 1 Radiation Protection Supervisor License is recommended.

2 Other precautions

The high-voltage power supply applied to an X-ray tube is a DC power supply with an output of 50–60 kV and 30–40 mA. This voltage is extremely dangerous for those who come in contact. The replacement of the X-ray tube and maintenance and inspection of the equipment should be performed after the power is turned off and the high-voltage charge is fully discharged.

Section 1 General preparedness

The scope of the outdoor activities of university students is not limited to the city and extends to all areas and environments, including forests, coasts, rivers, lakes, marshes, and mountainous areas. In addition, by school of engineering nature, it may require to perform activities in mechanically and biologically hazardous areas. Therefore, these activities require utmost care and attention as the smallest carelessness can lead to major accidents.

While conducting outdoor activities (e.g., field experiments and practical training), necessary information should be collected in advance, and accordingly, plans should be made in advance. It is important to have **more than one person** in a group in the case of accidents (e.g., slips and falls or encounters with wild animals). In addition, an instructor in charge of the field trip should accompany the group. If they are unable to accompany the group, plans and communications with them should be done in advance to obtain their approval before the trip.

Pay close attention to the site, do not stick to the plan execution, and act in a **safety-first** manner.

In the event of an accident or other unforeseen incident, remain calm, take appropriate measures, and contact relevant authorities immediately.

Section 2 Preparation before going out

1 Planning and information gathering

If there are cases of past activities, be sure to confirm the details of the activities and near-misses that occurred during the activity. When planning, allow plenty of time to travel and perform activities. Not only understanding geography, weather, and so on with map or weather forecast, ^{*1)} but also even if the weather is favorable, gather information on landslides, rising rivers, waves and tide level, the ecology of local wildlife, and how to posture safety if you encounter wildlife. ^{*2)}

The decision to implement the plan should be comprehensively made, considering the opinion of faculty members in charge. If the situation is predicted to be unfavorable, the project should be canceled. In a hazardous area where entry is restricted, you should contact the person in charge of the area and ask for permission in advance for performing investigations and/or operations.

Participants should be briefed on the itinerary, preparations, and other types of trip-related information of the selected trip date.

^{*1)} It would be advisable to know how to read **topographical and weather maps**.

^{*2)} Before the winter season of a bad harvest year of hard fruits, the probability of encountering bears in the morning and evening even outside the mountain forest is high.

2 Securing emergency communication channels and first aid training

Make sure to confirm in advance on how to contact in case of an emergency, and be sure to inform faculty members in charge, universities, and, if necessary, relevant authorities about the way to contact (e.g., cell phone number). Refer to the next section “Clothing and equipment” to gather information on the necessary equipment and clothing. Please read “Chapter 2 First-Aid Measures” carefully, and practice it beforehand if necessary, so that you can immediately deal with an injury or accident occurring onsite. Moreover, it would be advisable to know clinics or hospitals near the site.

3 Preparing clothing and equipment

(1) Clothing

Onsite, wear clothes and footwear with long sleeves and long pants, gloves, and boots, which are safe and possess few exposed skin areas. In addition, safety shoes, cold protection and waterproof clothing, and breathable rainwear to prevent heatstroke during summer season should be worn if required.



Work area-Safety First

(2) Equipment

a Onsite, wear clothing and footwear with long sleeves and long pants, gloves, boots, etc., that are workable and safe, and have few exposed skin areas. In addition, safety shoes, cold-weather and waterproof clothing, and breathable rainwear to prevent heat stroke in summer should be worn if necessary.

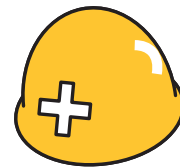

b In places where there is a risk of falling rocks, landslides, falls, avalanches, and falling water, prepare helmets and life jackets.

c To can be instantly treated for external injuries and sudden illnesses during outdoor activities, in addition to disinfectants for external injuries depending on the site, prepare cold medicines, digestive medicines, antibiotic ointment, antibiotics for taking, insect repellents, ^{*3)} antidotes for poisonous snakes, poultices, and small medical equipment, motion sickness medicine, and so on. Medicines vary depending on the target area, and it is the responsibility of each person to select appropriate medicines. Moreover, if necessary, prepare equipment^{*4)} for use while encountering wild animals.



^{*3)} Insect repellents containing dates, which repel ticks, are available.

^{*4)} There is a bear spray known as “Counter-Assault.”

d If traveling to an area where safe drinking water is not available, carry sufficient quantities of portable food and drinking water.

e Keep cell phones as a means of communication. Cell phones may be used for a long period; therefore, carry external battery packs. While traveling to areas where cell phones cannot be used, it is advisable to prepare a means of communication (e.g., cell phones that can make satellite calls, specified low-power transceivers^{*5)} (no license required), and amateur radio^{*5)} (license required)).

*5) Telephony distance—Specified low-power transceivers: several hundred meters; amateur radio: several kilometers.

- f Keep backup lights (e.g., headlamps and others) as the sun may set earlier than expected during the activity.
- g Keep necessary equipment for activities with regard to each specialty.

4 Advance notification

Faculty members in charge should notify the university in advance and make prior contact with relevant authorities. Students should consult with the faculty members about the required documents and notifications and ask them to submit the documents when necessary. The following documents are required to be submitted:

- (1) Field experiment/practicum implementation plan (should be submitted)
- (2) Travel order inquiry (travel application form)
- (3) Permits to enter restricted areas*6) (apply and obtain from relevant authorities)

*6) Refer to “Field precautions (7) investigation and work in hazardous areas.”

- (4) Other notifications required for activities in the respective fields of expertise.

5 Confirmation of accident insurance

While a disaster or accident occurs, medical treatment and rescue incur a high cost. While conducting outdoor activities, it is desirable to have appropriate insurance coverage supposing the occurrence of various disasters and accidents.

At Nagaoka University of Technology, students are required to join the “Personal Accident Insurance for Students Pursuing Education and Research” upon enrollment. This insurance is applicable to “injury” during “educational and research activities.” It includes onsite and accidental injuries during transportation (moreover, there is a special clause for coverage during commuting to and from the University). However, this insurance does not cover illness or disasters (earthquakes, volcanic eruptions, tsunamis, and others). If necessary, other insurance schemes should be purchased as well.

- Excerpt from the Student Life Guidebook (page 25) -

Personal Accident Insurance for Students Pursuing Education and Research (**PAS usually called Gakkensai**) is an indemnification program designed to **grant necessary benefits to indemnify for an injury, etc., caused by a sudden or random accident of an external origin** in the course of educational and research activities (including commuting to school and extracurricular activities), thereby contributing to enhancement and development of education and research activities of universities. **All the students of this university are required to enroll in this insurance at the time of admission.**

■ An "injury" shall include the following items but **shall not include diseases**

- ① Toxic symptoms arising suddenly from the accidental inhalation, absorption or consumption of toxic gases or substances in one breath (excluding toxic symptoms arising from continuous inhalation, absorption or consumption).
- ② A physical impediment arising from sunstroke or heatstroke.

■Other cases not covered by the insurance

Willful acts, acts of conflict, suicide, crime, earthquakes, eruptions, or resulting tsunamis, war, riots, radiation or radioactive contamination, accidents caused while driving unsafely due to being unlicensed or under the influence of alcohol, **accidents in the student houses**, accidents due to such an act, or in such a place or at such a time as is prohibited by the university, **accidents during dangerous outdoor extracurricular activities** including mountain climbing and skydiving, etc. **Accidents that do not fulfill the conditions of being sudden, unexpected, and of an external origin, such as acute alcoholic intoxication caused by drinking alcohol** are not covered.

Scope of compensation	Death benefits	Physical disability benefits	Medical benefits	Additional hospitalization benefits
During regular curriculum /school events	20 million yen	1.2 million to 30 million yen	3,000 to 300,000 yen	4,000 yen per day
During periods when the insured is on school premises other than the above stated. While participating in extracurricular (club) activities outside of school facilities which are reported to the university	10 million yen	600,000 to 15 million yen	In the case of treatment for 4 days or more 6,000 to 300,000 yen	
During the commute to school or transit between school facilities			In the case of treatment for 14 days or more 30,000 yen to 300,000 yen	

- * **If you have an accident, report to Division of Student Affairs immediately**, for the accident may not be covered by the insurance even if it falls under categories above or the insurance money may not be paid if your accident report is delayed.
- * Said number of days for treatment means the actual number of treatment days from the date of the start of treatment up to the date the injury is cured to the extent that the insured can return to normal life (the actual number of days of hospitalization or commuting to hospital). Please note that not all the days during the treatment period are covered.

Section 3 Local preparedness

1 Local precautions

When in the field, do not stick to the planned itinerary, but act in a **safety-first** manner, paying attention to the following points:

- (1) Act in groups of several people and avoid acting alone as much as possible.
- (2) Carry identification, insurance cards, and entry permits.
 - a Carry a student ID card, driver’s license, or other identity proof.
 - b Carry a copy of your insurance card to cover possible injury or illness during the survey.
 - c If a permit for passage or entry is required,*7), carry that as well.

*7) Refer to “Field Precautions (7) Investigation and Work in Hazardous Areas.”

(3) Health management

- a Outdoor activities are physically exhausting and should be discontinued if you are not feeling well. If you notice any physical discomfort during the survey, stop work immediately and seek medical advice if necessary.
- b When the body becomes wet due to low temperatures or rainfall, the body becomes cold and unwell and movements become slower. This can be a factor in accidents; thus, keep your hands, feet, and neck warm.

(4) Traffic safety

- a While traveling to and from the site by a car, follow traffic laws and regulations, and pay attention to speed limits and distance between vehicles.
- b Be careful while traveling by a car to conduct surveys and while working in town.
- c When working outside a vehicle, wear a helmet and high-visibility clothing, and be aware of passing vehicles.



Drive Safely...

(5) Standing signs

If there are warning signs of “Landslide Danger Zone,” “Dam Release Caution,” and “Beware of Bears” near to you, be sure to read them carefully.



Check signs

(6) Weather

When the weather worsens or after sunset, the work should be stopped without exertion, and the crew should withdraw from the site. Even if the weather is favorable, there are cases where disasters are likely to occur (e.g., landslides and other ground disasters caused by bad weather, torrential rains in the upper reaches of rivers, rising rivers owing to dam releases,*8) and high waves caused by typhoons). Moreover, as there are times when wild animals are more active, always pay attention to the surrounding conditions and never take unreasonable actions.



Act safely!

*8) For example, the **Shinano River**, which runs through Nagaoka City, is 367 km long. Here, floodwaters upstream can take up to **2 days** to reach Nagaoka; thus, the **water may rise even when the weather in Nagaoka is clear.**

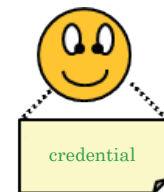

(7) Surveys and work in hazardous areas, nature conservation areas, and wild flora and fauna

- a Avoid surveying in areas where entry is prohibited (e.g., landslide areas and collapsed areas, hazardous areas, and construction sites).

Carry around your credentials

- b If it is necessary to survey or work in a prohibited area or danger zone, contact the person in charge of the area and obtain official permission in advance; follow their instructions on the day of the survey or work. If a permit is available, be sure to carry it with you.
- c In hazardous areas where there is a risk of falling rocks and landslides or where there is a possibility of encountering natural creatures, take precautions to avoid accidents by wearing protective gears, e.g., helmets and work clothes, and life jackets when you are near water areas, which include beaches, rivers, lakes, and marshes. Avoid acting alone and be aware of your surroundings. Be especially careful immediately after bad weather, as it can be dangerous.
- d Note that few survey sites and activities may require prior permission.*9) In addition, while working underwater, underground, or under special circumstances, for instance, in areas surrounded by animals,*10) be sure to work together with an experienced person.

*9) Refer to “(9) Preservation of natural environment (a) to (c).”

*10) Be aware that qualifications similar to that of a diver may be required depending on the situation.

(8) Observance of sociality

- a Surveys and work on private property should be conducted after obtaining the consent of the landowner. Moreover, be mindful not to invade the privacy or public nature of others. In urban areas and crowded places, do not disturb others.
- b Do not behave in a manner that may lead to the destruction of nature or damage to property.
- c Be aware that collecting plants and animals that are cultivated, farmed, or bred is equivalent to theft.

(9) Preservation of the natural environment

- a Do not unnecessarily destroy the natural environment. In particular, do not collect rocks, animals, and plants in areas where there are legal restrictions such as national parks, national monuments, prohibited areas for collection, or bird and animal sanctuaries. If it is necessary to do so in the course of your research, consult with your instructor and be sure to contact the relevant authorities to obtain official permission.

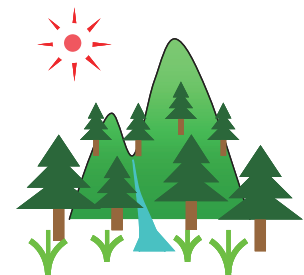

Preserve nature

- b If you wish to **capture birds or animals for research**, you need to submit an **application for permission** to the relevant municipality or prefecture and obtain permission in advance. Note that in areas designated as natural monuments, it is necessary to obtain **permission to change the current status**.*11) Some areas of oceans, rivers, lakes, and marshes have fishing rights; therefore, please obtain a license or permit as necessary. If you have a license or permit, carry it with you.

*11) It may take up to 2 months after application for approval; therefore, please apply as soon as possible.

- c Even in areas where there are no legal restrictions, avoid overfishing and moderately collect required items.

(10) Others

Accidents may occur in fields that are difficult to predict, and each person should act based on common sense according to the situation. In addition, be sure to learn what situations (dangers) may occur on a daily basis.

2 What to do in case of unforeseen circumstances

If an emergency or unforeseen situation arises, calmly assess the situation without panicking, and take appropriate measures according to the situation. Moreover, contact the university and other relevant institutions.

In the event of an emergency situation that results in injury, illness, or a person in distress, contact the relevant authorities in accordance with the details described in “(6) First-aid measures in emergency situations during outdoor activities” and “Chapter 2: First-Aid Measures.” If necessary, take first-aid measures for the person involved. It is advisable to read the first-aid procedures beforehand.

(1) Injuries and illnesses

Take measures in accordance with the details described in “(6) First-aid measures in emergency situations during outdoor activities” and “Chapter 2: First-Aid Measures.” If necessary, go to a nearby hospital. If the person is unconscious, unable to walk, or cannot be transported, call for the rescue team.

(2) Distress

- **In the case of an incident involving yourself:** Act with caution while attempting to contact the outside world by means of communication. In inclement weather and at night, temperatures drop even in the summer season, and body temperature and physical strength are depleted. Be sure to conserve physical strength and reserve food and other supplies while giving due consideration to clothing.
- **In the case of an incident involving companions:** Request rescue according to “(6) First-aid measures in emergency situations during outdoor activities.” You may search by yourself until help arrives, but be sure to do so to the extent that you can ensure your safety. If you find a person in distress, assess his/her condition according to “(6) First-aid measures in emergency situations during outdoor activities,” and take first-aid measures if necessary. When the police or other authorities arrive, explain the situation and take over the search and take first-aid measures.

(3) Falling water and drifting

- **In the case of an incident involving yourself:** Do not unnecessarily go against the current^{*12)} and get ashore as soon as possible. Wearing wet clothes will significantly deplete your strength; therefore, change or dry yourself immediately. If you are unable to reach shore on your own, try to conserve your strength and wait for the rescue team.
- **In the case of an incident involving companions:** Do not approach unnecessarily^{*13)} and attempt to secure the accident victim by throwing ropes or objects. If it is impossible to secure the person, call for help according to “(6) First-aid measures in emergency situations during outdoor activities.”

While waiting for help to arrive, you may try to secure the victim yourself, but be sure to do so within the limits of your safety. Once the accident victim is secured, assess his/her condition according to “(6) First-aid measures in emergency situations during outdoor activities,” and take first-aid measures if necessary. When the police or other authorities arrive, explain the situation and take over the search and take first-aid measures.

*12) If the current is strong, it is advisable to concentrate on staying afloat while waiting for the rescue team and conserving your strength.

*13) Even if you are in a safe place, there is a high possibility that you will be grabbed onto by your companion, causing you both to fall into the water together.

(4) Ground collapse, house collapse, and avalanche

▪ **In the case of an incident involving yourself:** Exit the building or go outdoors as soon as possible. If you cannot escape, remain calm and wait for the rescue team while trying to ensure your safety and conserve your strength as much as possible. If you are injured, take first-aid measures in accordance with “Chapter 2 First-Aid Measures.”

▪ **In the case of an incident involving companions:** Do not approach them unnecessarily, but call for help in accordance with “(6) First-aid measures in emergency situations during outdoor activities.” You may attempt to secure the injured person by yourself until help arrives, but be sure to do so within the limits of your safety. Once the accident victim is secured, assess his/her condition according to “(6) First-aid measures in emergency situations during outdoor activities,” and take first-aid measures if necessary. When the police or other authorities arrive, explain the situation and take over the search and take first-aid measures.

(5) Encounters with wild animals

While doing activities in nature, one may encounter various wild animals (e.g., bears, wild boars, monkeys, deer, and snakes). If you encounter these, do not panic and deal with the animal as you have studied them beforehand*14).

*14) For example, if you encounter a bear, if it is > 15 m away, you should back away slowly, keeping your eyes on the bear. If the bear **attacks** you, assume a safe posture. Never run away. In the case of a wild boar, it is best to climb to a tree or pole by at least 1 m in height.

(6) First aid for emergencies during outdoor activities

In the event of an accident, the steps shown in the flow chart below should be taken. Read it carefully in advance to understand the action flow.

Emergency contacts are the police (110) and emergency services (119), as well as the Japan Coast Guard (118) in the waters.

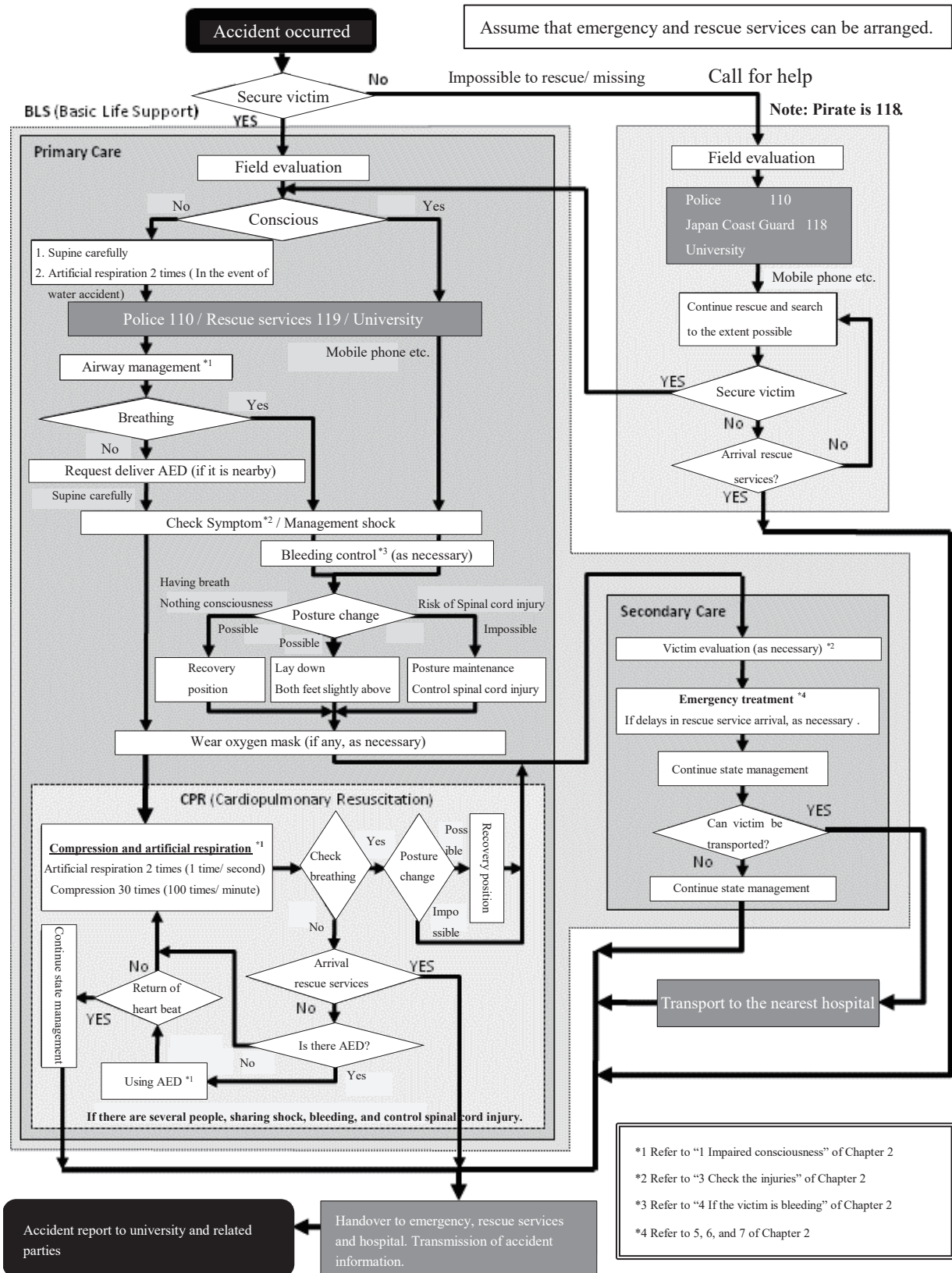

Section 4 Post-completion preparedness

Upon returning from the field, report to concerned parties that the activity has been completed. A record of the activity will be kept for future reference.

(1) Ensure physical health

During outdoor activities, people may get injured without realizing it, or they may be carrying insects or seeds. In case of injury, appropriate measures should be taken immediately. If a tick is attached to you and you are bitten, immediately go to a hospital to report the tick bite and have it treated.

(2) Report the end of your trip

Upon returning from the outdoor activity, report to the instructor or the person in charge that the activity has been completed, including a summary of the activity and necessary information.

(3) Document the details of activities conducted

It is advisable to document the day's record, notes, and reflections, and add them to the preliminary materials. As the activities and notes will be useful for subsequent activities, any particular points for improvement should be discussed afterward to contribute to future activities.

(4) Early preparation

Meetings should be held when new students are assigned to new laboratories and before the start of surveys to review past activities and near-miss cases and share findings with all the members.

Section 1 Earthquake safety measures

1 Precautions against earthquakes

(1) General suggestions

a Heavy items (e.g., bookshelves, shelves, and safes) should be installed on walls and/or beams to prevent them from tipping over or sliding. Check with the facilities section before securing them. Items that are not secured should be considered to be in motion. For example,

- Safes: They are quite heavy that they are difficult to move under normal circumstances; however, during an earthquake, even heavy objects are subjected to acceleration. Thus, considerable force is required to secure them.

- Suspended objects: When shaken with large amplitude, they may fall by colliding with surrounding objects or the ceiling.

b To secure the evacuation passage, no objects should be placed in corridors, emergency exits, and stairways. In addition, never fasten objects across fire doors or place objects in front of the doors as they may limit the doors to prevent the spread of fire and smoke.

c Take precautions against the spread of fire.

d Always keep a flashlight in the laboratory.

(2) Consider safety measures in laboratories

a Protection for laboratory equipment and machinery against earthquakes

Tall or unstable objects may topple over, and heavy objects may slide out. In addition, piping and wiring may come off owing to misalignment between devices. Therefore, these objects should be secured with sufficient holding power.

b Safety measures for high-pressure gas cylinders

As leakage of high-pressure gas owing to overturned cylinders is extremely dangerous, which may lead to human casualties, in the event of an earthquake, cylinders should be securely fastened to the wall at two points (upper and lower) with chains to prevent them from overturning. (It is advisable to use sturdy anchor bolts.)

c Take measures to prevent falling of lockers, etc. and scattering of glass.

Measures to prevent falling of lockers, etc. and scattering of glass

a. Measures to prevent falling of lockers, etc.

壁にとめる方法 How to fasten to the wall

Fasten with L-shaped steel hardware and anchor bolt.

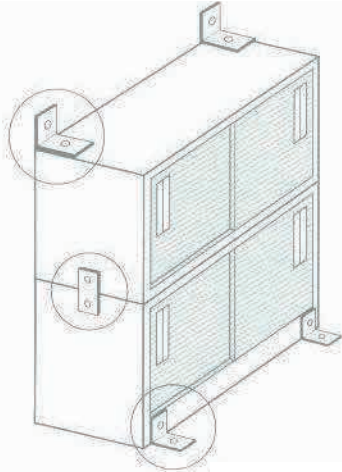

Furniture weighing more than 200 kg should be equipped anti-skid.

If the weight of the furniture is less than 200 kg, it may be fastened with two No. 16 steel wires (diameter 1.5 mm) and L-shaped steel hardware.

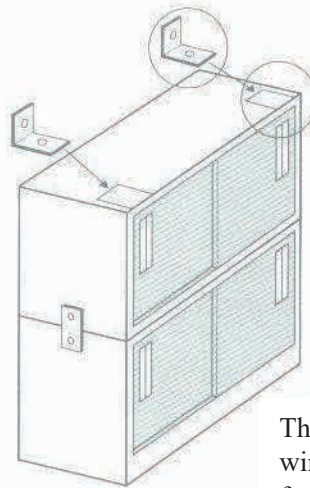

The angle between the wire and the top of the furniture should be less than 30 degrees.

床にとめる方法 How to fasten to the floor

Fasten two places with L-shaped steel hardware and anchor bolt.

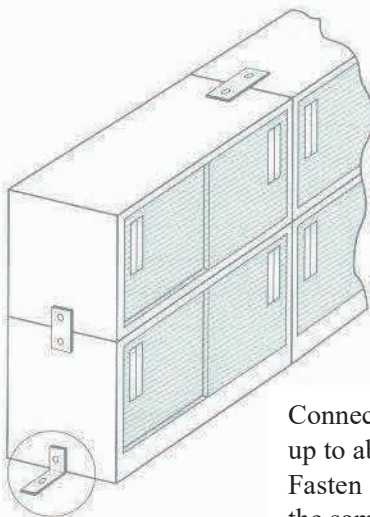

Connecting furniture is up to about 3. Fasten the other side in the same way.

Fasten two places with L-shaped steel hardware and anchor bolt.

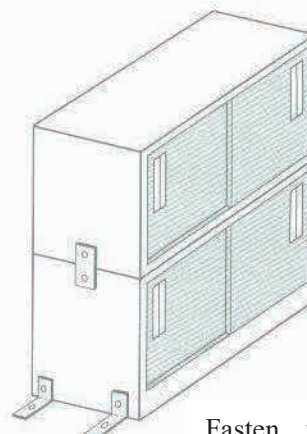

Fasten the other side in the same way.

家具を連結する方法 How to connect furniture

If connecting so that the width is at least half the height, it becomes difficult for furniture to fall.

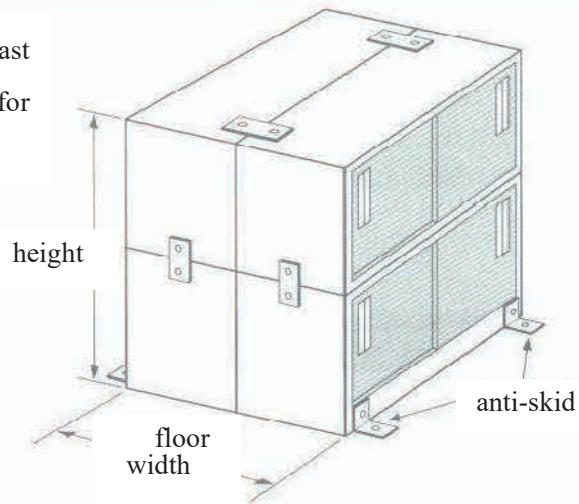

棚のとめ方 How to fix shelf

Fix the shelf to the wall, spread soft mat to avoid slide and fall items on the shelf, and attach "SAN".

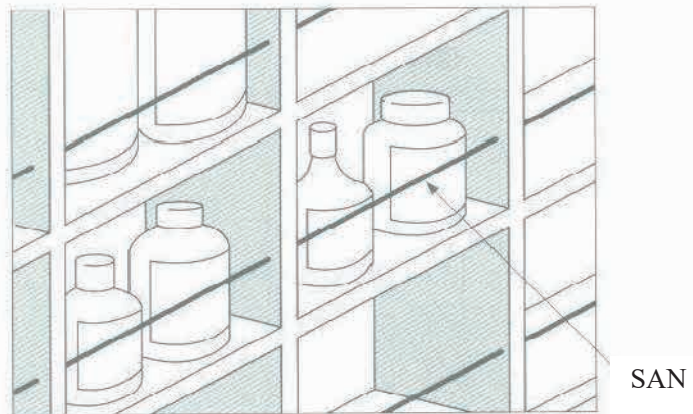

Hazardous materials such as chemicals should be taken measures to prevent falling and attached gridded partition board to prevent collisions between containers.

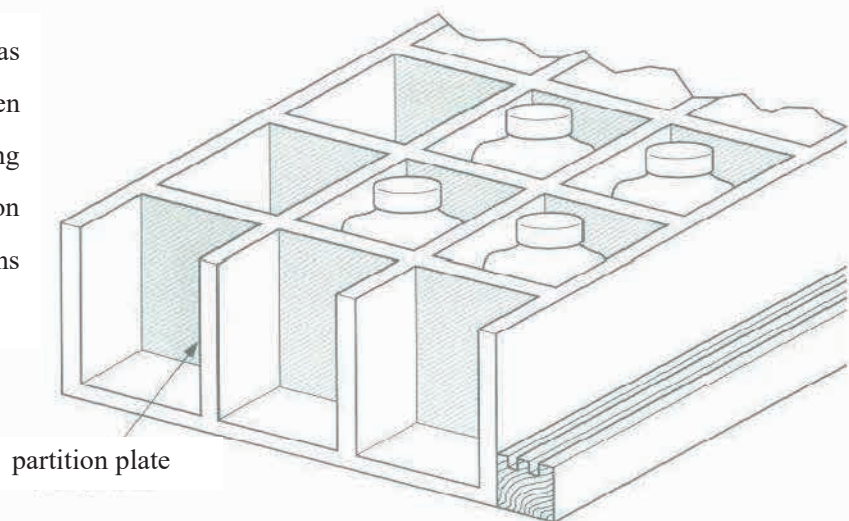

b. Measures to prevent scattering of glass

①Renovate not to scatter if glass brake.

- Use wired glass

(Note: It may cause cracking if rainwater get in from cross section of glass and rust occur, so be careful with waterproofing during construction.)

- Stick Shatterproof Film inside of the glass.

②Use adhesive tape. (emergency measure)

If warning declaration has been issued, window that did not take renovation or scatted prevention should be sticked adhesive tape that are effective in breakage prevention of window as emergency measure.

粘着テープの貼り方 How to stick the adhesive tapes

○The tapes should be sticked inside of the window.

Does not sticked well if dirt or moisture is left, so stick firmly after removing them sufficiently.

○ How to stick is the most effective when sticked vertically and at equal intervals like figure A.

The smaller space between individual tapes, the more effective.

○ There is also how to stick like figure B, but it is better to stick like figure A if the amount of tapes is same because the effect is small.

Figure A

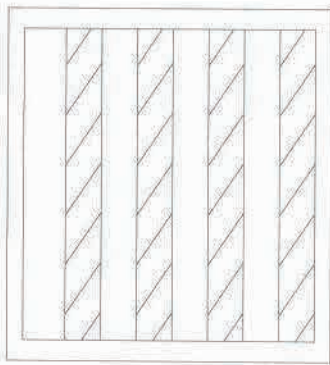
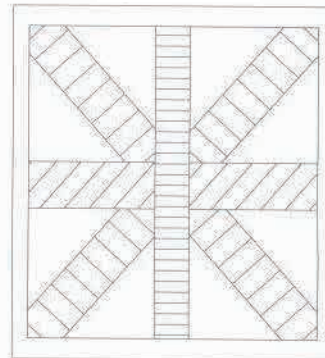

Figure B



d Storage of chemicals

During an earthquake, chemical containers on shelves or laboratory tables can fall or break, causing chemicals to spill or scatter. In such a situation, depending on the conditions, the mixture of chemicals may cause ignition, and if there are combustibles in the vicinity, the intensity of the fire will increase and cause severe damage.

The following preventive measures should be considered:

- (1) Noncombustible chemical cabinets should be used (as much as possible) and secured to walls to prevent them from tipping over.
- (2) Chemical containers should be placed in separate storage cases and secured to the cupboard.
- (3) Ignition chemicals should be sorted and stored separately.
- (4) Keep chemical containers away from the laboratory table as far as possible.

2 If an earthquake occurs

(1) If you feel an earthquake

The strength of seismic motion is determined based on the earthquake scale (magnitude) and distance from the epicenter.

If the distance from the epicenter is short, even if the earthquake scale is not so large, the seismic motion will be significant, which indicates the feeling of the first vertical wave.

If the distance between the epicenter and seismic scale is large, it is common for large earthquakes to be followed by long-period large lateral shaking without vertical motion.

The most important thing to remember is that, when you feel an earthquake, do not panic; however, you should act first and foremost to ensure your safety.

(2) Quickly put out fires and hazardous materials

If an earthquake is felt to be strong, it is necessary to take measures to prevent fires from being started or dangerous gases from leaking out by shutting down equipment or preparing to shut down as quickly as possible, stopping experiments, putting out fires, and deactivating cylinders. However, if a large tremor suddenly occurs, one's safety should be prioritized.

(3) Sheltering in a safe location

Move to a safe place. If you feel the earthquake is large or are working in a hazardous area, quickly leave the area. Physical safety should be your priority.

If you are in a reinforced concrete building, find a large empty space and stay there as long as possible. Steel furniture and bookshelves may topple over; therefore, do not lean against them. Be aware of falling objects (from above) and broken glasses; it is safe to get under desks. In rooms with vinyl floor tiles, furniture may slip and move. Heavy furniture is especially difficult to move in normal circumstances; however, during an earthquake, it can easily slide and may get stuck between walls or other objects, making it difficult for you to move in that space.

After shaking subsides, if there are any tasks left to be performed, e.g., putting out fire, do it quickly.

(4) If fire breaks out, extinguish it first

Even in universities, the risk of fire requires special attention.

When fire is caused by a major earthquake, it may spread outside the university, and thus firefighters putting in effort may not be able to focus on their targeted region; therefore, they should call out everyone and try to extinguish the fire in the initial stages.

Although initially firefighting is important, aftershocks continue; thus, your safety should be prioritized.

(5) About evacuation

If a fire in the building cannot be extinguished or if hazardous gases are present, evacuate the building immediately.

While evacuating, use the stairs instead of the elevator.

3 Post-earthquake procedures

(1) Caution for aftershocks

The main shock is followed by aftershocks. Several aftershocks occur within the epicenter of the main shock (several hundreds per day) when they are felt. The number of aftershocks gradually decreases; however in the case of a major earthquake, they may continue for several months. Aftershocks are smaller in magnitude than mainshocks; however, if they occur together, they can cause a significant impact. However, aftershocks are usually weaker than the main quake.

Aftershocks may damage or topple buildings; thus, please take extra precautions with regard to your safety.

(2) Maintaining order

Maintaining order after a disaster is especially important. In other words, it is necessary to assume various situations in advance and consider measures to deal with them (e.g., maintaining order in terms of security, preventing confusion caused by rumors, and dealing with the movements of evacuated citizens and the university's response to them).

(3) Measures to be taken in laboratories

After the disaster, cleanup and other measures in each laboratory should be promptly considered, with emphasis on the following points:

- a Treatment of fire hazards
- b Ensure that all electrical switches and main gas and water valves are turned off.
- c Disposable items that may topple over, especially the damaged ones.
- d Before cleaning up damaged laboratory equipment and other related items, click pictures of the damaged items and save them as evidence. This can be later used as documents to request disaster recovery expenses.

(4) Building and equipment inspections

Inspect the damage to buildings in your vicinity and contact Division of Facilities Affairs if any abnormality is found. In particular, report any damage, large or small, that is deemed to be in danger of falling or collapsing. In addition, the pictures of the damaged site shall be preserved as documentary evidence.

Piping and wiring attached to the building should be inspected and reported. Electricity, gas, and water may not be supplied to the end of the line until the buildings and facilities have been inspected.

Section 2 Earthquake and fire safety measures

1 Fire caused by an earthquake

Figure 11-1 shows the causes of fire caused by main urban earthquakes in Japan. A large percentage of the causes were related to heater and electricity (electrical equipment, wiring, etc.). Moreover, fire caused by chemicals cannot be ignored. During the Kanto, Niigata, and Miyagi earthquakes, the percentages ranged from 22% to 27%. Careful attention should be paid to chemical fires, ignition of leaked gas, and ignition of combustible materials by heating equipment or other fires.

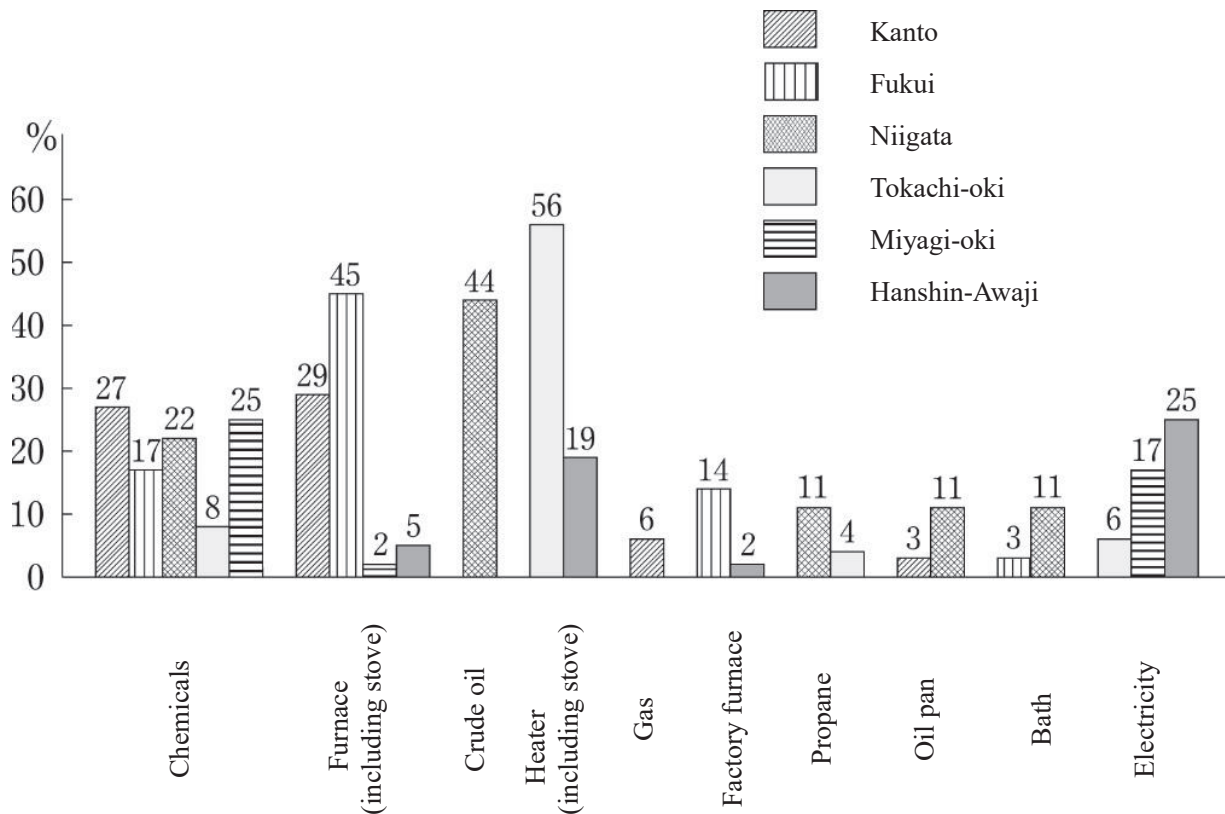

Figure 11-1 Major causes of fires due to earthquakes in Japan

2 Earthquake fire safety measures under normal circumstances

(1) Normal preparations in the event of an earthquake

- a Fire extinguishers and firefighting methods
- b Information systems and training
- c First aid equipment
- d Leakage control (chemicals and gases)
- e Evacuation measures

(2) Safety measures for chemical storage cupboards

The following points should be considered as measures with regard to chemical storage cupboards.

- a The cupboards should not fall over.
- b Chemical containers should not fall.
- c Chemical bottles should not break on the shelves, and even if they do break, the inner boxes should be designed in a way so that chemicals do not flow out.

(3) Management of chemicals and oils

The following items should be managed under normal circumstances based on the sufficient knowledge of chemicals described in Chapter 5.

- a Information of the actual storage conditions of chemicals
- b Assessment of the hazardousness of chemicals
- c Proper storage arrangement of chemicals
- d Proper storage arrangement of oils

(4) Evacuation route(s)

- a In the case of ignition or explosion of chemicals, leakage of hazardous chemicals, or fire caused by gas or heating equipment, and considering the occurrence of accidents (e.g., toppling of laboratory equipment, cupboards, and bookcases and cracking of window glasses), in the event of an earthquake, determine in advance secure escape routes of each laboratory.
- b Do not place hazardous materials, cupboards, lockers, and/or other furniture items in front of corridors, stairways, or other passageways.
- c Confirm the locations of emergency ladders and emergency exits if the designated evacuation routes (e.g., corridors and stairways) become impassable.

3 Fire suppression in the event of an earthquake

- a During an earthquake, immediately turn off the main valve and power source of gas taps; heaters e.g., stoves; and heating equipment, and evacuate to a safe place after confirming the safety of the place.
- b In the unlikely event of fire or other accidents, immediately notify the Energy Center (9290), follow their instructions, and take appropriate measures.
- c Initially extinguishing fire is important, and fire extinguishers or fire hydrants provided should be used to extinguish the fire.
- d If fire in a building becomes unmanageable in the initial stages of extinguishing the fire, immediately evacuate the building using the evacuation route as in other routes, there can be a possibility of gas, high-pressure gas cylinders, and/or chemical explosions.
- e Refer to Chapter 5, Section 1, Table 5-3 for fire types and applicable fire extinguishers.

Section 3 Fire prevention and suppression

1 Fire prevention

If fire breaks out, it can cause injuries to people and extensive damage to buildings and facilities; therefore, it is necessary to take additional precautions.

Therefore, the following precautions should be considered to prevent fire:

- a While using fires, keep combustibles at a safe distance and the surrounding area tidy constantly, and do not leave the area.
- b After using a fire extinguisher, completely put out the fire and check for safety.
- c Electrical wiring and gas piping must not be changed or installed without permission.
- d Familiarize yourself with the location and operation of fire extinguishers and hydrants, and do not place anything in the vicinity that may interfere with their operation.
- e Smoking should be prohibited on the premises including in the car.
- f Before leaving the premises, check and confirm the fire safety.
- g If any mismanagement of fire is found, take appropriate measures immediately.
- h The required amount of inflammable or combustible chemicals should be brought into the room and used and stored with the utmost care.

2 What to do in the event of a fire

- (1) If fire is discovered in a place, push the emergency button of a nearby fire alarm, repeatedly shout “Fire!”, and notify others in the same place or those who are nearby.
- (2) Extinguish fire using fire extinguishers or fire hydrants (initial fire extinguishing). (See Sections 4.2 and 4.3 for instructions on how to use fire extinguishers.)
- (3) Notify the fire department (119) of the type of accident (fire or emergency), location, name of the building, and fire conditions (location of fire, burning materials, whether or not anyone escaped, etc.), and call the Energy Center (9290) and the emergency call center (9999, after hours: 0258-47-9999 * Wait for a while as a hold music is played until the transfer is complete.)
- (4) Turn off power and gas sources, and quickly remove flammable materials from the area.

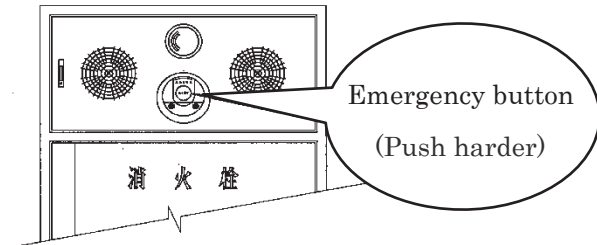

3 Evacuation

- (1) If initial firefighting proves to be ineffective and the situation becomes unmanageable, immediately evacuate to a safe place.
- (2) While evacuating, after shutting off the power and gas sources and disposing of hazardous materials, make sure no one is inside, and close windows and exit doors.

- (3) It should be ensured that evacuation routes in corridors are upwind of smoke movement.
- (4) Elevators should not be used.
- (5) It is necessary to consider evacuation routes and carefully examine emergency exits.
- (6) Even if a fire door in a corridor is closed, it can be opened by pushing or pulling lightly; thus, you should act calmly.
- (7) Do not place any object in front of fire doors to prevent them from closing. By closing fire doors, smoke and flames are blocked, and evacuation routes become secured in the event of fire. Moreover, it needs to be careful always not to place any objects in front of fire doors.

Section 4 Disaster prevention equipment and alarms

1 Fire alarm system

(1) Automatic fire detectors

Each room is equipped with a heat detector (differential spot type or constant temperature spot type) for automatic fire alarm, and smoke detectors are installed in the indoor stairwells, which are constantly monitored by receivers at the Energy Center. In addition, there are receivers or sub-receivers installed in the department offices, where fire can be located as well. As such, it is advisable to check the location and display content of the receivers on a daily basis.

When a detector is activated, the fire alarm bells and emergency broadcasts on that floor (the floor on which the fire broke out), and the floor above it (the floor directly above it) will generate sound. (All buildings with three or fewer floors ring simultaneously.) This is a measure to prevent confusion during evacuation.

Location of fire alarm receivers

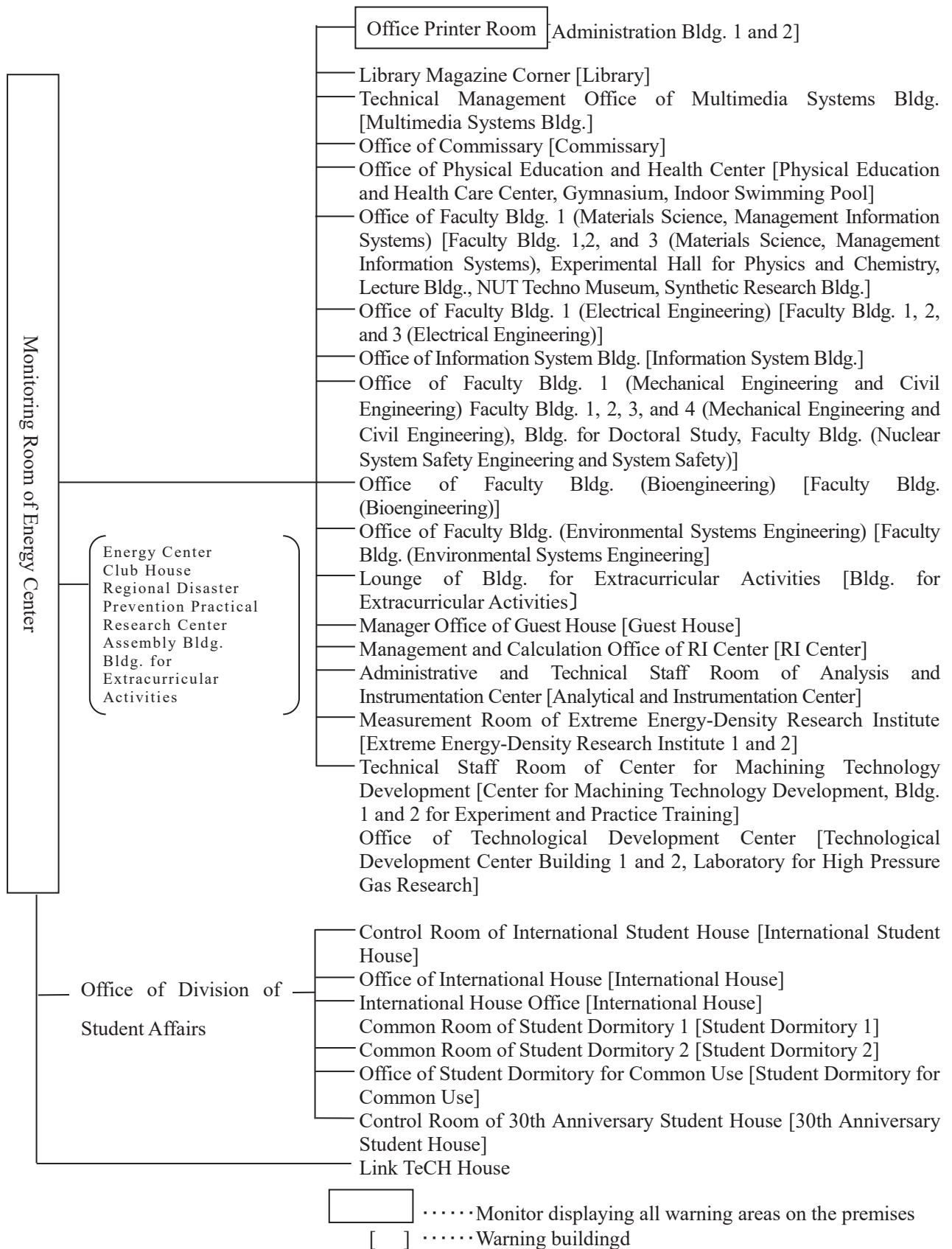

2 Fire extinguishers

They are installed in the corridors of each building (and some in the laboratories) and are very effective as a means of initial firefighting in the event of fire.

Most fire extinguishers on the premises are ABC powder extinguishers, which can be used to extinguish ordinary fire, oil fire, and electrical fire.

It is important to be familiar with the usage instructions (which are indicated on the extinguishers) and to confirm the location of the extinguishers. Moreover, it is necessary to actively participate in fire drills to become familiar with its operation.

How to use the fire extinguisher

How to use the fire extinguisher

- 1 Pull out the safety plug (yellow ring).
- 2 Hold the part near the end of the hose and point it toward the fire.
- 3 Squeeze the lever firmly.
- 4 Aim directly at combustion and spray in a wide arc, as if sweeping with a broom.

3 Indoor fire hydrant system

Major buildings at the university are equipped with indoor fire hydrants.

While using these hydrants, because the water pressure is stronger than expected, three or more people should familiarize themselves with the following procedures before operating them. (These instructions are indicated on the back of the hydrant box door.)

How to use indoor fire hydrants

- 1 Press the transmitter button on the top of the hydrant box.
(The hydrant pump starts, the indicator light blinks and the fire alarm bell rings.)
- 2 Open the door of the fire hydrant box.
- 3 Hold the nozzle and extend the hose.
- 4 Open the valve to release water.

4 Outdoor fire hydrant system

Outdoor fire hydrants are installed in the Lecture Bldg., Faculty Bldg. 1 (Materials Science, Management Information Systems), Experimental Hall for Physics and Chemistry, Gymnasium, Commissary, Center for Machining Technology Development, and Student Dormitory.

As the pressure is higher than that of indoor hydrants and the volume of water is larger, three or more people need to be familiar with the following procedures before using the hydrants:

How to use outdoor fire hydrants

- 1 Open the door of the fire hydrant box.
- 2 Hold the nozzle and extend the hose.
- 3 Press the activation button inside the hydrant box.
- 4 Open the valve to release water.

5 Halide fire extinguishing system

A halide fire extinguishing system is installed in the Particle Beam Laboratory of Extreme Energy-Density Research Institute 1.

In case of fire, Halon 1301 is released by operating the manual activation device.

Before the release, a synthesized voice will broadcast an evacuation advisory, so evacuate immediately.

6 Broadcasting equipment

Broadcast loudspeakers are installed throughout the premises and can be used for broadcasting during an emergency or at any time.

Broadcast amplifiers are installed in the offices of each department, Physical Education and Health Care Center, Analysis and Instrumentation Center, and Technological Development Center, to enable broadcasting to each area. In addition, Energy Center and Administration Bldg. 1 are equipped with broadcasting equipment that can select each area and simultaneously broadcast to the entire campus.

7 Fire door equipment

Fire doors are installed in the middle of corridors (for the flat sections of buildings) and stairway entrances (for vertical hole sections) for fireproof compartments. The doors are automatically closed in conjunction with smoke detectors, and during evacuation, the doors are opened and closed as necessary to secure the passage. The operating status of the fire doors is notified to the control panel in the office of the department (combined receiver with fire alarm) and the receiver in the energy center by a light indicator and buzzer.

8 Elevator control operation

(1) Fire control operation

When fire breaks out, the elevators in the building enter the fire control operation mode; they are forced to go directly to the evacuation floor (1st floor), and the doors open once and then close to stop. The operation panels inside and outside the elevator indicate that the elevator is in the fire control operation mode, and an announcement is automatically made inside the elevator.

(2) Earthquake control operation

When an earthquake occurs, elevators in premises automatically go into earthquake-controlled operation. When the elevators enter earthquake-controlled operation, they are forced to stop at the nearest floor, open the doors once, then close them, and come to a stop. (*To open the doors again, press the “Open” button on the operation panel inside the elevator.) The operation panels inside and outside the elevator indicate that the elevator is in earthquake-controlled operation, and an announcement is automatically made inside the elevator.

Section 1 Work environment, accidents, and disasters

As shown in Figure 12-1, H.W. Heinrich, one of the pioneers of the disaster prevention technique, illustrated how accidents and disasters occur, which is known as Heinrich's domino theory. Figure 12-1 is known as Heinrich's Five Dominoes and represents the following causal relationships:

- (1) Disasters caused by accidents
- (2) Accidents caused by unsafe actions of people or imperfections of objects in their surroundings
- (3) Unsafe actions and conditions caused by personal defects (physical or mental)
- (4) Personal defects caused by adverse social and environmental conditions

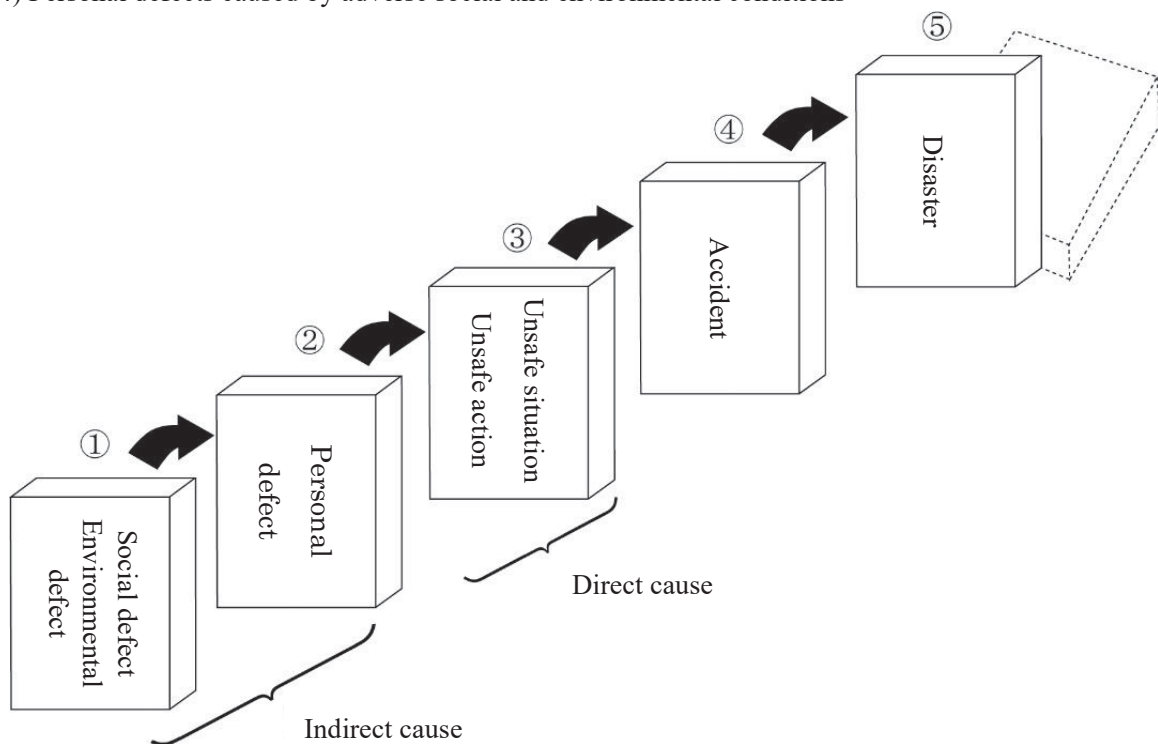

Figure 12-1 Heinrich's Five Dominoes

Thus, accidents and disasters are caused by several defects. Therefore, if any one of these defects is removed, accidents and disasters will not occur.

In this chapter, we consider removing the first domino (Figure 12-1). In other words, we demonstrate the work environment setups for each of the following items: (1) temperature and humidity, (2) air and ventilation, (3) lighting and illumination, and (4) noise and vibration.

Deficiencies in the work environment lead to accidents and disasters and cause health issues (Table 12-1).

Table 12-1 Major health issues owing to environmental and working conditions

Environmental and working conditions		Major health problems
Conditions caused by environmental conditions	1 Due to thermal conditions	Heatstroke, frostbite, and cold sores
	2 Due to lighting, hazardous rays, and ionizing radiation	Myopia, cataracts, electro-ophthalmia, and ionizing radiation damage
	3 Noise, vibration, and ultrasonic waves	Hearing loss, leukorrhea, arthralgia, bone and joint deformities, and ultrasonic disorders
	4 Due to abnormal atmospheric pressure	Decompression sickness
	5 Hazardous gases, vapors, and dust	Metal fever, lead poisoning, mercury poisoning, chromic acid poisoning, carbon monoxide poisoning, vinyl chloride poisoning, organic solvent poisoning, pneumoconiosis, skin disorders, and occupational cancer
	6 Conditions caused by oxygen	Oxygen deficiency disease
Conditions caused by working conditions		Low back pain, back pain, cervico-omo-brachial syndrome, and bouncy finger (spring fingers)

Section 2 Temperature/humidity

Unlike ordinary homes and offices, workplaces require a certain degree of temperature and humidity for the production process or other environments that cannot be avoided in the course of work, resulting in uncomfortable conditions.

Temperatures between 18 and 24 °C are considered suitable in a work environment. Humidity is closely related to temperature, and one indicator of this relationship is the discomfort index shown in the following equation:

$$\text{Discomfort index} = (\text{dry bulb temperature } (^\circ\text{C}) + \text{wet bulb temperature } (^\circ\text{C})) \times 0.72 + 40.6.$$

The relationship between this discomfort index and comfort and discomfort is shown in Figure 12-2. Therefore, as shown in the figure, the working environment guidelines for temperature and humidity can be determined.

Even with the same temperature and humidity, our estimation of the temperature differs depending on the state of the current airflow. When wind blows, generally evaporation of sweat is promoted, conduction increases, and feel cool or cold. However, when the temperature is very high and the humidity is high, the wind makes us feel hot and humid.

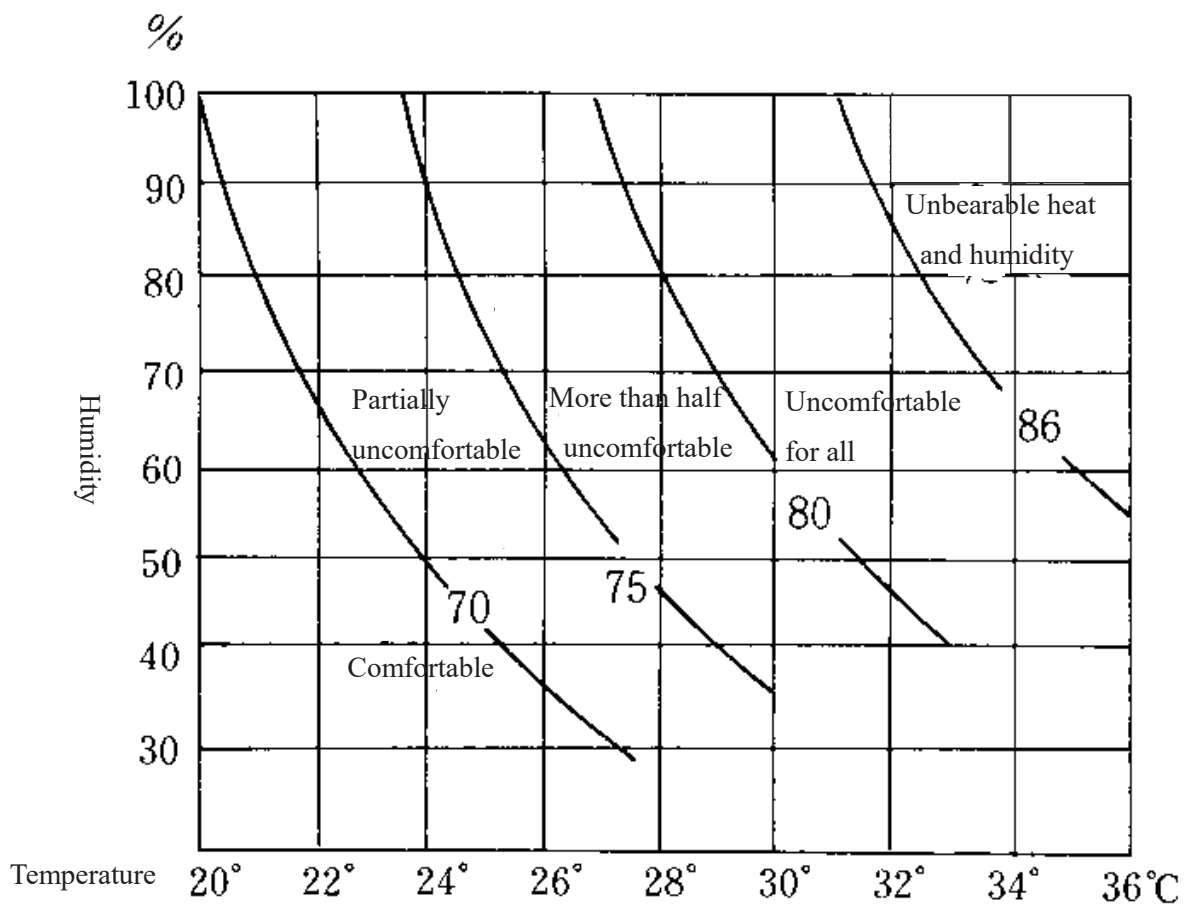

Figure 12-2 Discomfort index

Section 3 Air and ventilation

In the indoor air environment where common operations are performed, the concentration of dust, carbon dioxide, carbon monoxide, and other pollutants increases with human activity, which can impair comfort and adversely affect work efficiency. These, along with temperature and humidity mentioned in the previous section, are our most familiar work environments, and their effects cannot be ignored.

The focus should be on dust, specified chemical substances, lead, and organic solvents because their concentrations in the air in the working environment significantly fluctuate per place over a period. To prevent exposure to such hazardous substances, the use of local exhaust ventilation, push-pull ventilation, or total ventilation is the most common and effective method.

Standards for a working environment have been established and are listed in Table 12-2.

Table 12-2 List of sanitation standards for offices/workspaces

Item		Standard		
Air environment	Air volume		10 m ³ /person or more	
	Windows and other openings		The area of the largest open area must be at least 1/20 of the floor area (if the area is less than 1/20, a ventilation system must be provided).	
	Indoor air quality standards	50 ppm or less	50 ppm or less	
		0.5% or less	0.5% or less	
	Temperature	Heating and other measures shall be considered.	Heating and other measures shall be considered.	
		The temperature should not be significantly lower than the outside temperature (the difference from the outside temperature should be within 7 °C).	The temperature should not be significantly lower than the outside temperature (the difference from the outside temperature should be within 7 °C).	
	Air conditioning equipment	Quality of supply air	Suspended dust (~10 microns or less)	0.15 mg/m ³ or less
			Carbon monoxide	10 ppm or less
			Carbon dioxide	0.1% or less
			Formaldehyde	0.1 mg/m ³ or less
		Indoor air standards	Airflow	0.5 m/s or less
			Room temperature	Strive to maintain the temperature between 18 and 28 °C
			Relative humidity	Strive to maintain the humidity between 40% and 70%
	Mechanical ventilation system	Quality of supply air	Suspended dust	0.15 mg/m ³ or less
Carbon monoxide			10 ppm or less	
Carbon dioxide gas			0.1% or less	
Formaldehyde			0.1 mg/m ³ or less	
Airflow in a room		0.5 m/s or less		

Section 4 Lighting

Lighting and illumination in the workplace significantly impact comfort and work efficiency. Even the slightest deviation from optimal conditions can strain the visual environment and create health problems. For example, under conditions where workers cannot see well or cannot see without effort, the visual function becomes not only burdened, but also thus errors increase, leading to an increase in defective products and a decrease in production and various health issues or unexpected injury caused by the extra inhalation of dust and gas because of the proximity of the eyes to the workbench.

There are five types of lighting methods: direct, indirect, semi-indirect, general, and local lighting. The selection should be made according to the type and method of work. The following points should be considered during the selection process:

- (1) Illuminance should be appropriate for the type of work. The required illuminance is specified in the JIS illuminance standard (Z9110-2010), an example of which is listed in Table 12-3.
- (2) Illuminance should not be dazzling under normal working conditions.
- (3) The light source should not move.
- (4) The light source should not create strong shadows on the work surface and floor.
- (5) The light source should not create a large difference between the ambient brightness and brightness of the work surface. (General lighting should be at least 1/10 of the brightness of local lighting.)
- (6) The light color should be suitable for the nature of the work.

Table 12-3 Illuminance requirements according to JIS (Table 10 for factories)

Type of area, task, or activity		$\bar{E}_m(\text{lx})$	U_o	UGRL	Ra	Notes
Work	Extremely detailed visual work in precision machine and electronic component manufacturing and printing plants (e.g., assembly a, inspection a, testing a, and sorting a)	1500	0.7	16	80	$Ra \geq 90$ when color is important, 2000lx for ultra-precise viewing tasks.
	Fine visual work such as sorting and inspection in textile factories, typesetting and proofreading in printing factories, and analysis in chemical factories (e.g., assembly b, inspection b, testing b, and sorting b)	750	0.7	19	80	$Ra \geq 90$ when color is important, 1000lx for precision viewing tasks.
	Ordinary visual work in general manufacturing processes (e.g., assembly c, inspection c, testing c, sorting c, and packaging a)	500	0.7	-	60	$Ra \geq 90$ when color is important.
	Limited to rough visual work (e.g., packaging b and packing a)	200	-	-	60	

	Very rough and limited visual work (e.g., packaging c and packing b, c)	100	-	-	60	
	Design and drafting	750	0.7	16	80	
	Monitoring of instrument panels and control panels in control rooms	500	0.7	16	80	1) Control panels are vertical in several cases. 2) Dimming is desirable. 3) For VDT work, refer to JIS illuminance standard (Z9110-2010) 4.8.
	Clerical work in the warehouse	300	-	19	80	
	Loading, unloading, moving loads, etc.	150	-	-	40	
Office spaces	Design and drafting rooms	750	-	16	80	
	Control room	200	-	22	60	
Public spaces	Warehouse with operations	200	-	-	60	
	Warehouse	100	-	-	60	200lx for persistent use.
	Electrical room and HVAC machine room	200	-	-	60	
	Toilet and washroom	200	-	-	80	
	Stairs	150	-	-	40	Liminal areas are provided at entrances and exits to avoid sudden changes in brightness.
	Indoor emergency stairs	50	-	-	40	
	Corridors and passageways	100	-	-	40	
	Exits and entrances	100	-	-	60	

Notes The following three categories shall be used according to the nature of the object and work to be looked at with regard to same type of task name.

- a) “a” in the table represents smooth objects, dark objects, objects of weak contrast, particularly expensive objects, cases related to hygiene, cases requiring a high degree of precision, and cases requiring long working hours.
- b) “b” in the table represents the intermediate between a) and b).
- c) “c” in the table represents objects that are coarse, light-colored, sturdy, and inexpensive.

Section 5 Noise and vibration

Noise causes discomfort to people, interferes with conversations and signaling, often adversely impacts safety, affects physiological functions, and can cause hearing impairment. (1) loud sound, (2) sound concentrated in a narrow frequency band (pure sound), (3) high-frequency sound, and (4) steady sound that is exposed for a long time are considered risky, with the acceptable standard being 85 decibels (dB). When noise prevention is not possible at the noise source or transmission path, **earplugs** should be used. If used properly, earplugs can reduce noise by 30-40 dB at >2000 Hz and by 10-20 dB between 200 and 2000 Hz. Table 12-4 lists the noise level and ambience of the place for reference.

Table 12-4 Noise level and on-site perception

dB	On-site perception	Examples
140		
130	Ears hurt, leading to headache	
120		Jet engine noise
110		When the window of a train is open when traveling in a tunnel
100	Desire to cover ears	When a train passes under the guard
90	Inability to talk to the person in front of you	Noisy factory
80	Cannot speak unless you raise your voice very high	Elevated railroad (inside a car)
70	Consciously speak louder	Crowded city and ordinary machine shop
60	Area feels noisy but able to have a normal conversation	Busy office interior
50	Ongoing light background noise that is disturbing	Office and quiet walking passerby indoors
40	Quiet but area not free from sound	Listening while in a crowd
30	Quiet and calm	Inside a broadcasting studio during a quiet night
20	Area feels silent	Sounds of leaves rustling
10		Whispering voice
0		Minimum audible sound in a soundproof room

The following methods can help prevent noise:

- (1) Reduction by improving location and layout, among others
- (2) Measures to counter sound sources
- (3) Room noise reduction through sound absorption
- (4) Reduction by sound insulation
- (5) Noise reduction by vibration isolation

The frequency of vibration ranges from 10 to 500 Hz, which can cause neurological symptoms in the fingers and upper extremities, Raynaud's phenomenon in the fingers, and other circulatory disturbances in people who use tools such as chain saws and rock drills that must be held by the hands for long periods. Vibration disorders do not commonly occur; however, increased vibration can cause discomfort, irritation, and other neuropsychiatric effects and reduce work efficiency and accuracy. Thus, vibration must be maintained at an appropriate level.

The permissible limit of vibration is related to frequency, amplitude, and time. Figure 12-3 shows the relationship between vibration frequency and amplitude.

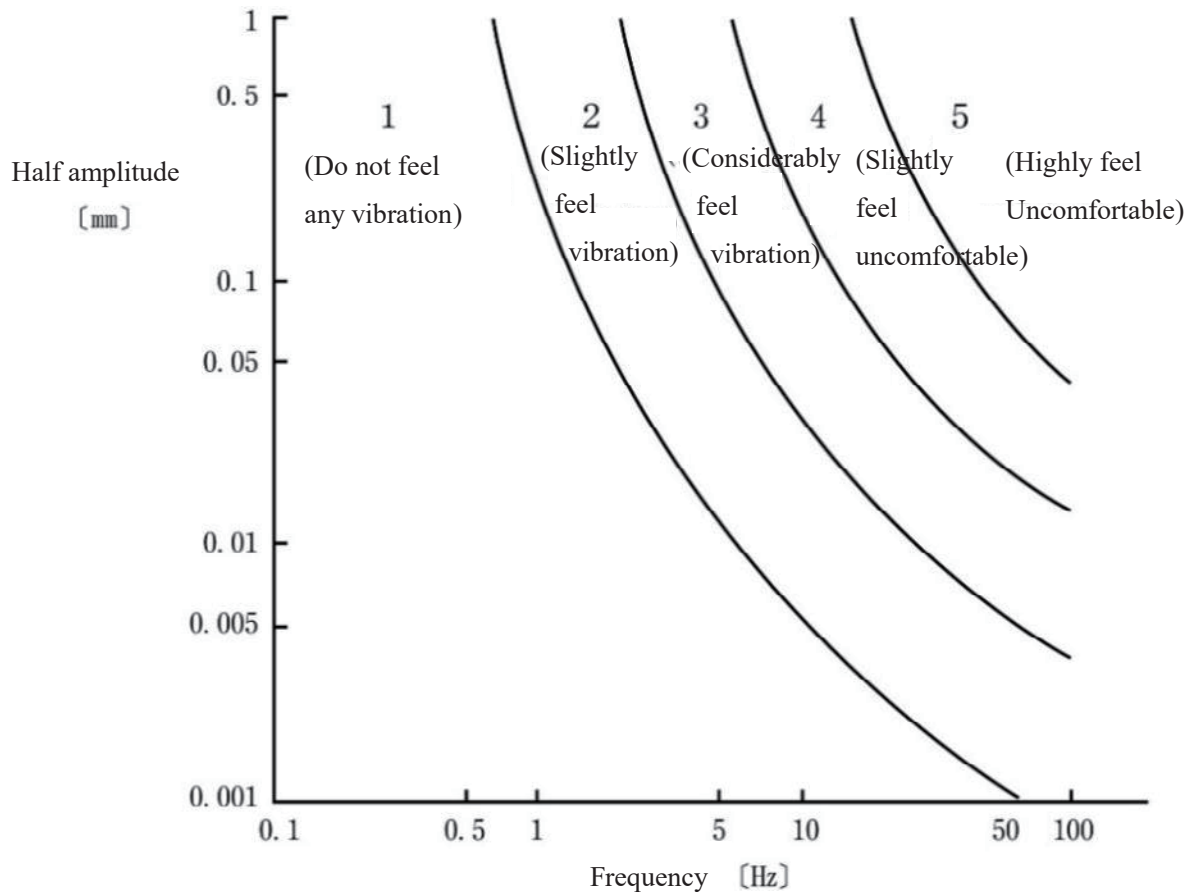

Figure 12-3 Five classification ranges of vibration sensation

Vibration prevention measures include the following steps:

- (1) Eliminate the cause of vibration
- (2) Interrupt the transmission path of vibration
- (3) Use cushioning materials
- (4) Modify the resonance point

Section 6 Disorder caused by IT equipment operations

The “Guidelines for Occupational Health Management in VDT (Visual Display Terminal) Operation” issued by the Director of the Labor Standards Bureau of the Ministry of Health, Labour and Welfare on April 5, 2002, has led to the implementation of measures to prevent disorders caused by VDT work. This is because the recent shift to information technology (IT) has considerably changed the working style in Japan, and computer operation (VDT work) has become a routine.

Since 2002, the use of IT in the workplace has significantly progressed, and the scope of workers who perform VDT work has expanded, and the work has become more diverse. Therefore, the guidelines will be revised as “Guidelines for Occupational Health Management in VDT Work” by the Director of the Labor Standards Bureau of the Ministry of Health, Labour and Welfare, on July 12, 2019.

1 Disorder caused by IT equipment operations

Subjective symptoms include eye fatigue, pain and dryness, stiff neck and shoulders, headache, back pain, lower back pain, arm pain, finger pain, numbness in the fingers, weakness in the hands, and stress symptoms.

2 Control practice (prevention)

Details are available at the URLs mentioned in the reference section. Thus, practical key points are described here.

(1) Work environment management

It includes appropriate lighting, lighting and glare prevention, noise reduction, appropriate chairs and desks for proper working posture, appropriate adjustment of information equipment, and other types of maintenance and management of the work environment.

(2) Task management

The following tasks are performed for 4 h or more per day:

Interactive operation-Creation, editing, and modification of text, tables, and related components based on the worker’s ideas; data retrieval, collation, addition, and correction; and sending and receiving e-mails

Technical operation, i.e., programming tasks-Creation and modification of computer programs and implementation of CAD tasks that include designing and drafting with the assistance of a computer (excluding simple input to CAD)

There are many types of IT equipment operation; these types possess different formats and contents. In addition, as the work effects on health significantly vary per person, uniform work management is not desirable. Therefore, it is desirable to provide IT equipment and related furniture and fixtures according to the characteristics of each worker and carefully consider the formulation of work plans that minimize the workload based on actual work conditions.

[Continuous work time and break time]

The purpose of work downtime is to prevent fatigue of workers caused by strain on their eyes, neck, shoulders, lower back, and upper limbs, resulting from gazing at the display screen, key operations, or a certain working posture for an extended period of time. Thus, they need to take a temporary break from work for a specific period and relax by looking at a distant scenery; closing the eyes; performing exercises such as stretching various parts of the body; or performing other tasks but not the so-called break time.

A short break is a pause of 1–2 min taken in the middle of a continuous work period. It is not a set time, but rather a break that workers can take at their will.

[Dry eye]

Dry eye (corneal xerosis) is a common disease; however, recently, it has been considered one of the most common disorders in information equipment operation. Blinking consciously is a good way to prevent it. Thus, during short breaks, you should blink consciously.

3 Reference URLs

Ministry of Health, Labour and Welfare “Guidelines for Occupational Health Management in Information Equipment Work

<https://www.mhlw.go.jp/content/000539604.pdf>

Appendix: Guidelines for Occupational Health Management in Information Equipment Work

<https://www.mhlw.go.jp/content/000580827.pdf>

Section 1 Introduction

Accidents happen often in physical education and sports even if safety measures are well implemented. Therefore, there is a need for advanced danger prediction and prevention (i.e., obligation to quickly stop an action or behavior when it is deemed dangerous) in physical education and sports. This should be considered by both the managing body and students of the university. Additionally, with the exception of special cases such as classes, self-responsibility is the general principle in sports. In fact, as previously stated, harmful actions could happen during sports, without necessarily violating a sports rule. Therefore, self-responsibility manifests in the fact that every participant is aware of the risk factors, and that they joined the activity with their own will and consent. Sports could be dangerous, but there is much to be gained from them. Therefore, the concept of the permissible danger doctrine was applied. Similar to driving a car, the same safety consideration obligations are required in sports.

From Section 2 onwards, the precautions for ensuring the safety for each facility are described.

Section 2 Pool

Figure 13-1 shows the details of an accident that occurred during a swimming class. The breakdown of accidents includes diving accidents, drowning accidents, and sudden death.

Previously, there was a lawsuit in a private sports club where a member with a pre-existing heart condition died after developing a heart disorder while swimming alone, and the lifeguard had left the location and was late to discover the situation. At our university pool, swimming members are constantly monitored, so even in the unlikely event of an incident, the discovery will not be delayed. However, if the lifeguard is absent for some reason, swimming must be avoided until the lifeguard is back in position. Furthermore, there have been many reports of sudden deaths during swimming that occurred after running. Students who can swim should not be overconfident in their youth and physical strength, and they should pay attention to their physical condition on that day, and carefully conduct preparatory exercises before swimming. Furthermore, if feeling unwell while swimming, then the swimming activity should be promptly ceased, and if necessary, the swimmer must come up to the pool side with the help of lifeguard etc. and keep warm. Simultaneously, based on the situation, the Health Office of the Physical Education and Health Care Center (extension 9824) must be contacted through lifeguard etc.

Accidents during swimming while under school management

Diving accidents 44%	Drowning 20%	Sudden death 25%	Other 11%
-------------------------	-----------------	---------------------	--------------

Circumstances of diving accidents in school pools

Cervical spine injury 77%	Tooth injury 17%	Death 6%
------------------------------	---------------------	-------------

(National Stadium and School Health Center of Japan)

Figure 13-1 Accident during swimming class

Reference: Kenji Hamada: It is because dangerous that let's instruct.

Security Sports Life. Vol. 6.

These also fall under self-responsibility. Only the individual knows their own physical condition. In addition, it is recommended that friends are invited to swim instead of swimming alone.

Diving accidents constitute over 40% of all accidents, and cervical spine injuries account for a little under 80% of swimming accidents. Unlike the percentage of sudden accidents, such as sudden death, this is thought to be an extremely high percentage even though practical guidance is provided during the class. In other words, diving is dangerous because it is a very difficult technique. The pool is equipped with a diving platform, but amateur students are discouraged to dive into the pool regardless of whether they are using the diving platform. Even for students of the swimming club, beginners should follow sufficient instructional procedures before diving into the pool.

Finally, these are some precautions from a hygiene perspective. Recently, bacterial infections have become a hot topic not only in pools but also in various facilities. At our university pool, water is disinfected with general chlorine and a circulation device is used to sterilize the water with ultraviolet rays. However, a large amount of hair or other substances floating in the pool may affect the circulation device. Therefore, swimming caps should be worn while swimming. Additionally, please use the shower before and after swimming.

Below is a summary of the main points to keep in mind for ensuring pool safety.

- 1) Students should not be overconfident about their physical strength, should pay attention to their physical condition of the moment, and conduct careful preparatory exercises before swimming.
- 2) When feeling unwell while swimming, student should immediately stop and retire to the poolside to warm up (contact the Physical Education and Health Care Center through a lifeguard).
- 3) Students should swim with multiple people instead of swimming alone as much as possible.
- 4) In the unlikely event that the lifeguard is absent, students should refrain from swimming.
- 5) Never dive in pool.

- 6) Students should wear a swimming cap while swimming.
- 7) Students should take a shower before and after swimming.
- 8) It is recommended for students to swim in places where their feet can reach (though there may be few such locations) to the extent possible. The maximum depth of the university pool is 1.6 m.

Section 3 Indoor physical education facility and training room

The university has an indoor gymnasium, martial arts hall, and training room as indoor physical education facilities. The general principle of self-responsibility, as well as management of physical condition and implementation of preparatory exercises, should be adhered to even when using these facilities.

The indoor gymnasium has a space for two basketball (or volleyball) courts and six badminton courts, and ball games are primarily conducted here. Relatively minor injuries such as sprains and jammed fingers are common in these sports. Severe injuries are rarely reported, unless the rules of the sport are violated significantly.

For example, badminton doubles are played by four people, but the size of the court is also regulated according to those rules. It is very dangerous for six people to play badminton on the court, even for practice, due to potential incidents such as hitting the body with a racket. As mentioned earlier, danger avoidance based on danger prediction are required when we play sports. In the indoor gymnasium, activity status should be constantly reviewed from the perspective of danger, and sports should be played based on the correct rules (please note that special precautions during the hot summer months will be mentioned for the outdoor physical education facilities).

The martial arts hall mainly involves martial arts club activities such as the judo, kendo, and karate clubs. Light sports such as table tennis are held on the board space. Precautions for students in each club that use the martial arts hall are mentioned.

For sports like karate, there are cases where excessive training and rule violations sometimes lead to court cases. Table 13-1 summarizes the classification and legal responses from the perspective of the danger of sports. Sports like judo, kendo, and karate are those where the martial arts spirit is learned based on the consideration of the other party by directly attacking the other party's body with hands or tools. However, it is extremely dangerous as it involves physical contact, and violation of the rules leads to illegality. Here, violation of the rules is equivalent to driving a car drunk on the road at 100 km / h.

Table 13-1 Classification and legal responses based on the danger of sport

Characteristics of sports	Applicable sports event	Legal response
Sports that directly attack the opponent's body with hands or tools	Judo, kendo, karate, boxing, wrestling, etc.	Rule violations are illegal
Sports conducted in dangerous places	Mountaineering, swimming, skiing, etc.	Advanced care obligations are required
Sports where some physical contact is expected	Ball games such as rugby, soccer, ice hockey, and baseball	Illegality if there is a significant rule violation

Reference: Tetsuro Sugawara, Sports Law Crisis Management, Eidell Institute (revised by author)

Students who participate in martial arts clubs or those who enjoy it should work hard to be considerate toward the other party, and mind the rules.

The training room has equipment such as treadmills, bicycle ergometers, weightlifting machines, and free weights. It is expected that many students will be free to use this equipment because training is easy to conduct by themselves.

However, considering the danger from the perspective of mechanically applying high loads or using weights, two or more people should be in the training room when in use. It is also encouraged to do physical condition management and careful preparatory exercises that are based on the principle of self-responsibility. Next, some precautions for each equipment are described.

The treadmill is an exercise device that conducts simulated running on a rotating belt. It is recommended that the left and right handles be held to support the body until familiarizing oneself with running in treadmill in order to prevent wobbling and falling. Furthermore, when running while letting go of the handles, it is preferable to run while looking straight ahead and having assistance to increase or decrease the speed. Please note that looking at the belt or looking to the side while running leads to falling. Furthermore, when feeling physical abnormalities or light-headedness while running, students should stop exercising immediately.

The bicycle ergometer is a bicycle-driven exercise device, and the risk of falling is low in this device unlike with a treadmill. However, users can fall from the saddle they are sitting on due to physical abnormalities or dizziness during exercise, so if any abnormalities are recognized, exercise should be stopped.

For treadmills and bicycle ergometers, instruction manuals should be carefully read and understood before using the equipment. Questions about their use should be directed to Shionoya of the Physical Education and Health Care Center (extension 9823, Email: shionoya@vos.nagaokaut.ac.jp).

Training with weightlifting machines and free weights (dumbbells, barbells) must be conducted with an appropriate weight load. There are large individual differences for this, but it is recommended that a weight that could be lifted at least 10 times (i.e., 10 rpm) be set as the starting point. Furthermore, free weight

exercises (especially barbells) must be conducted with at least one assistant. This should absolutely be adhered to so that the training individual does not crush their body (especially their chest) after being unable to lift the barbell. The assistant is in a position where the individual can always reach the barbell being lifted (position above the head when only one person: see Figure 13-2, position of left and right weight plates of the barbell when two people: see Figure 13-3), and should always keep the training individual in mind. When the training individual is tired and unable to lift the barbell, the assistant will promptly support and assist with the barbell. Questions regarding training using the weight machines or free weights should be directed to Shionoya, as mentioned above.

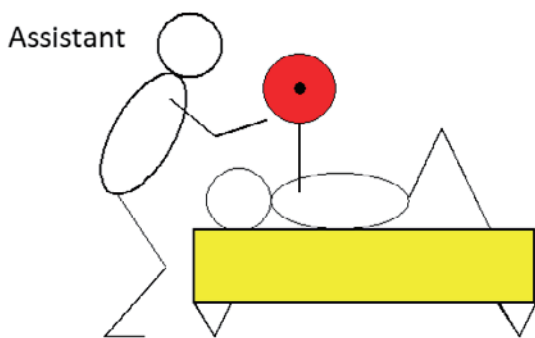

Figure 13-2 Position of assistant (one person)

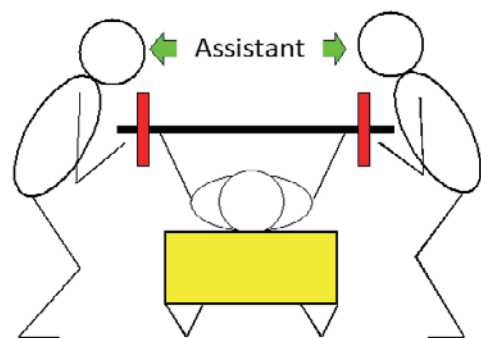

Figure 13-3 Position of assistant (two people)

The following is a summary of the main precautions for ensuring safety in indoor physical education facilities and training rooms.

- 1) Students should not be overconfident in their physical strength, should pay close attention to their physical condition, and perform careful preparatory exercises prior to their main exercises.
- 2) If students notice any abnormalities in their physical condition while exercising, they should promptly stop their exercise and contact the Physical Education and Health Care Center if necessary.
- 3) Students should not violate rules that may be dangerous in ball games performed at the Gymnasium.
- 4) Judo, kendo, and karate students who are practicing at the martial arts hall should not forget to be considerate of the other party and to comply with the rules due to the dangers related to physical contacts.
- 5) The training room must be used by at least two people at a given time.
- 6) Students should be fully aware of how to use the equipment when using a treadmill or bicycle ergometer.
- 7) Students must have at least one assistant when training with free weights (especially barbells).
- 8) Questions on usage methods or training methods should be directed to the Physical Education and Health Care Center.

Section 4 Outdoor physical education facilities

The university has a soccer field, baseball field, rugby field, tennis courts (six fields), kyudo-dojō, track field, golf driving range, and multipurpose turf as outdoor physical education facilities.

Even for exercises conducted in the outdoor physical education facilities, students should follow the general principle of self-responsibility and manage their physical condition as well as conduct sufficient preparatory exercises. These are not limited to just within the university but also to physical education and sports activities outside the university.

In Nagaoka City, where the university is located, it snows from December onwards, so the outdoor physical education facilities can be used until November, with peak period goes from June to September. During this time, students need to be mindful of heat stroke due to the hot and humid climate of Nagaoka, particularly in July and August. Heat stroke is a disorder that is caused by the imbalance of water and heat in the body due to heat and where normal function is impaired; this includes heat cramps, heat exhaustion, heat syncope, and heat stroke. Figure 13-4 shows the relationship between temperature/humidity and the risk of heat stroke. Heat stroke is caused not only by high temperatures but also high humidity. The risk of heat stroke increases when the temperature is 29 °C or higher or when the humidity is 90% or higher even when the temperature is low. Students need to pay attention to this not only in outdoor physical education facilities but also in indoor physical education facilities such as the gymnasium, which may not be well-ventilated.

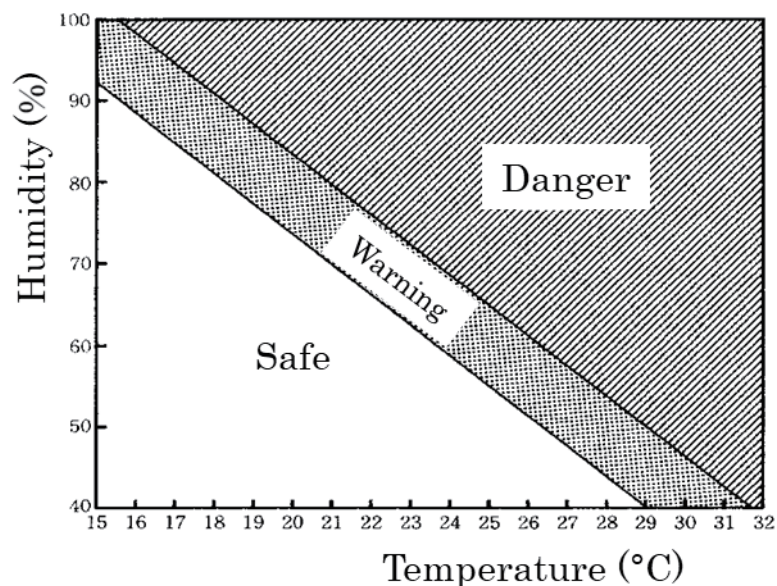

Figure 13-4 Relationship between temperature / humidity and risk of heat stroke
Reference: Hidetoshi Nomaguchi, Sports Accidents and Safety Measures. Baseball Magazine.

Risk factors for heat stroke are (1) playing sports over a long period (2) insufficient hydration, (3) rapid rise in air temperature, (4) high temperatures (29 °C or higher), and (5) high humidity (90% or higher), as well as the lack of self-responsibility, i.e., (6) continuing exercising with poor physical conditions.

Heat stroke prevention includes (1) providing sufficient hydration during sports activities, (2) avoiding sports during times of strong sunlight, (3) resting when feeling unwell, and (4) wearing clothes with good airflow. If feeling dizziness, headache, or nausea, then students should move to a well-ventilated and shady area such for rest (reference: Hidetoshi Nomaguchi, Sports Accidents and Safety Measures. Baseball Magazine). If symptoms are more severe, students should contact the Health Office of the Physical Education and Health Care Center (extension 9824). Please refer to the reference above and the webpage on heat stroke (<http://www.japan-sports.or.jp/tabid/523/Default.aspx>) for detailed information.

Lightning strikes are mentioned as a problem that is unique to outdoor physical education facilities. An average of 60 lightning strikes occur annually, and accidents during sports also occur. In terms of the frequency of occurrence, golf is the most common sport where such strikes occur, followed by soccer, rugby, and tennis, suggesting that this is an event that could occur the university's outdoor physical education facilities. Additionally, carbon fiber reinforced plastic (CFRP) using carbon fiber is the main type of sports equipment these days, but it has been statistically reported that carbon products have been involved in many lightning strikes. CFRP is used for golf clubs, tennis rackets, baseball (metal) bats, bows, etc. Students should be careful when using such equipment.

Safety measures against lightning strikes include (1) evacuating to a building or a car, (2) moving to a safe place even when a distant thunderstorm occurs, (3) sheltering in place, (4) using a large object (height of four meters or more) for protection (i.e., two meters or more away from the object and at an elevation angle of 45 degrees or less) and lowering posture as much as possible, (5) evacuating to a dry location, (6) avoid gathering in one location, and (7) letting go of protruding items (e.g., bats, rackets) (reference: Hidetoshi Nomaguchi, Sports Accidents and Safety Measures. Baseball Magazine).

Please refer to the above reference for information on lightning strikes.

Finally, safety measures at the golf course are described. Figure 13-5 shows the tee ground at a private golf course. The size of the tee ground may differ slightly based on the golf course; however, as shown in the figure, the magnitude and degree of safety confirmation obligations vary depending on whether the tee ground is separated (or not), whether the tee ground and moving space are separate (or not), etc. Many accidents at the golf course are caused by the club that is swung at the tee ground striking another person. Thus, the person trying to swing the club must pay close attention to their surroundings, including their back and perform a safety check before swinging. Simultaneously, the surrounding people must also pay close attention to the movements of the person who is about to swing the club. Furthermore, if there is no clear separation between the tee ground and the moving space, then the person who is about to swing the club needs to be careful and conduct safety checks.

The same incidents can occur on tennis courts as well.

The following is a summary of the main points to keep in mind for ensuring safety in outdoor physical education facilities.

- 1) Students should not be overconfident in their physical strength, should pay close attention to their physical condition, and perform careful preparatory exercises prior to their main exercises.
- 2) If students notice any abnormalities in their physical condition while exercising, they should promptly stop their exercise and contact the Physical Education and Health Care Center if necessary (same as for pools and indoor physical education facilities up to this point).
- 3) Students should be able to take preventive measures against heat stroke.
- 4) Students should be able to take preventive measures against lightning strikes.
- 5) Students should not forget to be careful and ensure safety checks at the golf course.

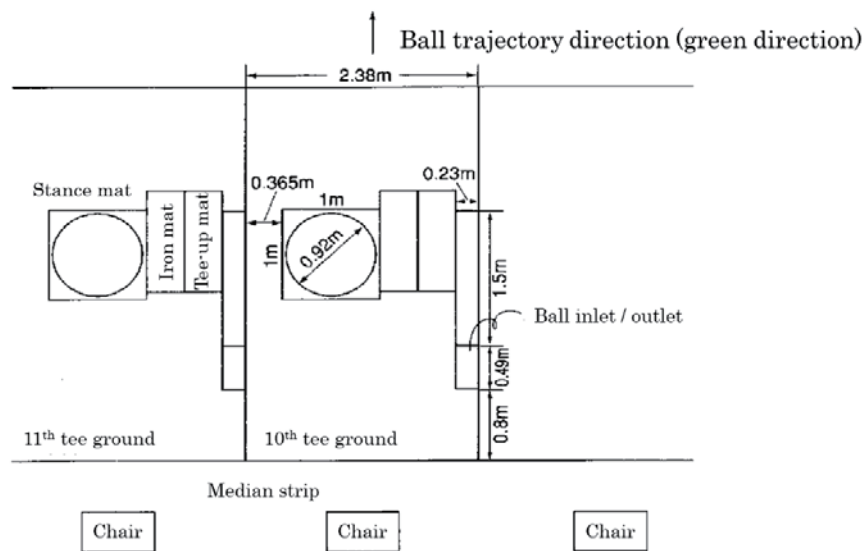

Figure 13-5 Tee ground at private golf course

Reference: Koichiro Mochizuki, “Cases of injury at golf courses” Security Sports Life. Vol. 4

The measures for ensuring safety in physical education and sports have been described, and new needs will likely emerge depending on the situation. The basis for ensuring safety in such situations involves **danger prediction obligations based on self-responsibility and the corresponding danger avoidance obligations (i.e., obligation to immediately stop actions and behaviors that are considered dangerous to avoid that danger), and the ability to do so.** By acquiring such abilities, students will likely be able to incorporate physical education and sports activities as part of their enriching student life.

Section 1 Positioning of w-SDS at the University

Safety is important in education and research activities in universities. At this university, we have begun the publication of our “Safety Manual” and made various efforts throughout the university and each laboratory.

Incidentally, laws such as the Industrial Safety and Health Act are stipulated to prevent the recurrence of previously occurred accidents. The content of the law can be considered as a checklist that is prepared by learning from past accidents, which can serve as a reference for universities as well. Therefore, the President of the University has made the following statement (also stated on the back cover of this manual).

Nagaoka University of Technology Safety and Health Policy [Basic policy] excerpt

- **Prepare a work-Safety Data Sheet in order to establish a cross-sectional management method related law and regulations that apply to equipment, facilities, or work that uses such items.**

Meanwhile, (1) it is incredibly difficult for us, who are not legal experts, to know the laws and regulations in such a cross-sectional manner; (2) governmental laws and regulations are made with production factories in mind; thus, there are some cases and situations that cannot be directly applied to universities. Therefore, the work-Safety Data Sheet (w-SDS)⁽¹⁾ was developed to ensure the safety and promote education/research by listing laws and regulations for each equipment/facilities, material (substances), work⁽²⁾, and risk assessments.

Against this backdrop, the University will prepare and submit a w-SDS to all laboratories to improve the safety of educational and research activities. The submitted w-SDS will be returned after approval by the President (general safety manager).

Section 2 Overview of w-SDS and preparation/submission

As mentioned above, the w-SDS comprises legal and risk assessment components. Correspondingly, the w-SDS is prepared as follows:

Every November, all laboratories are required to prepare or review their w-SDS. This process is divided into the following four steps:

1. Hold a meeting among faculty and other members of the laboratory, bearing in mind the safety of the equipment/facilities and activities in the laboratory.

⁽¹⁾At the University, w-SDS is first prepared by managing equipment and facilities.

⁽²⁾Developed by Noboru Sugimoto (University of Kitakyushu at the time of development), Isamu Shiota (SHIOTA Safety Plan), and Katsuya Hachiman (University of Occupational and Environmental Health at the time of development).

2. Regarding equipment/facilities that require legal management, check the items that must be managed (e.g., applicable equipment) while referencing the w-SDS. Prepare a w-SDS for the new equipment.
3. Conduct a risk assessment for dangers associated with the use of equipment, and consider countermeasures as needed.
4. Submit the above results together in the “Meeting Record” and “w-SDS”.

Step 4 is conducted by the faculty and staff, but steps 1-3 are to be done by all members of the laboratory, including students. Therefore, a safety meeting is to be held once a year in the laboratory. These meetings should be used as an opportunity to review the safety of our daily education and research activities, and active participation is encouraged in these meetings.

Satisfactory results are achieved by safely conducting research. The occurrence of an accident results in the stopping of the research and no results being produced, as well as the possibility of irreparable physical disabilities occurring. To prevent such situations, it is helpful if all members will think about and be aware of the safety issues.

Section 3 Useful information for w-SDS preparation

- Guideline for work-Safety Data Sheet Activities

https://www.nagaokaut.ac.jp/gakunai/designated/jinji_romu/SDS/w-sdstop.files/w-sds_youkou_e.pdf

- Creation guide

https://www.nagaokaut.ac.jp/annai/jyoho/jyohokoukai/sds/sds_top.files/w-sds_teiyun_open.pdf

- w-SDS template

https://www.nagaokaut.ac.jp/annai/jyoho/jyohokoukai/sds/w-sds_sample.html

- w-SDS working group

e-mail address (consultation counter) sds-wg@jcom.nagaokaut.ac.jp

- Section of Welfare and Employee Affairs, Office of Personnel and Employee Affairs, Division of Administrative Affairs

e-mail address romu@jcom.nagaokaut.ac.jp, ext. 9206

Prevention of experiment-related accidents, etc.

During experiments or practice, please attempt to prevent accidents according to the instructions from the faculty and staff.

The following **accidents** have occurred in the past.

No.	Accident example	Overview
1	Solution entered eyes because of not wearing protective glasses during experiment.	During the process of transferring solution from test tube to glass cell for measurements, a drop that spilled into another beaker of the solution below bounced and got into the eyes of the student. The student was not wearing protective glasses.
2	Explosion of experimental equipment	When a combustible and combustion-supporting gas were mixed and discharged for an experiment to produce fine particles, an explosion occurred inside the device and the acrylic plate lid was blown to pieces. There were no physical injuries due to the explosion, but the student collapsed due to anemia when cleaning up after the accident. The student was injured by hitting the corner of the laboratory table and cutting the forehead.
3	Cutting fingertip with machine tool	While cutting a large metal plate using a foot-pedal-based cutting machine, the pedal unexpectedly touched the footrest, the blade descended, and an injury occurred—the tips of the middle and ring fingers of the left hand were cut.
4	Gas leak from gas cylinder	After completing an experiment using high-pressure gas, the main valve of the gas cylinder was not closed, and the regulator was malfunctioning (when the secondary valve is closed with the main valve open, the gauge indicating the secondary pressure rises and the safety valve opens), so the gas leaked and a foul odor was generated in the laboratory and surrounding rooms. No human damage was reported.
5	Ignition from wiring cord	During electrical and instrumentation work, the cords that were connected to the voltage measuring instrument were bundled and used. This generated heat, melted the coating the device, and resulted in ignition (presumed). No human damage was reported.
6	Accident due to upper plate of experimental device	The student forgot that the upper plate of the experimental device was hung by a crane, and their head hit the plate causing an injury in the right eyebrow.
7	Accident during gas filling	During gas filling, the glass bottle burst, pieces of glass splattered, and approximately 2 cm of the student's left ring finger was cut.
8	Slipping and falling	When coming to pick up experimental materials, the student slipped and fell, tearing their chin on the partition block of the material storage area.
9	Broken glass trap	While removing the pressure-resistant rubber tube on the trap inlet side, the liquid inside was suddenly pushed out to the outlet by atmospheric pressure. The force broke the glass trap and caused a shallow cut with a length of approximately 15 cm from the scattered glass pieces.
10	Cuts caused by cutter grindstone fragments	When cutting a round iron rod with a fine cutter, the rotating grindstone was damaged and scattered debris, one of which hit the student's head near the right eye and caused a cut of approximately 2 cm.

No.	Accident example	Overview
11	Acetone ignition due to overheating of hot plate	A powder obtained by mixing titanium powder, hydroxyapatite powder, and a small amount of acetone was put into a metal plate and heated on a hot plate, whereupon the acetone ignited and generated a fire.
12	Rupture of glass chemical bottle during etching process	When the waste liquid of an etching solution that was separately prepared with different concentrations of nitric acid and hydrochloric acid was mixed in a glass bottle and its lid was closed, the bottle burst and scattered, damaging the front glass of the fume hood.
13	Getting caught between sample and fixed vise.	When attempting to fix a semi-cylindrical metal material to the base of a band saw cutting machine with a vise to cut it, the left thumb holding the material was placed between the vise and material was caught.
14	Chemical burns caused by concentrated sulfuric acid	A beaker, which contained a strongly oxidizing solution, slipped out of the hands of a student and broke, and the solution spilled on the student's limbs.
15	Fire caused by forgetting to turn off power supply	The heater in the plastic bucket was overheated, the water in the bucket evaporated and became "empty," the heat of the heater ignited the plastic, and the fire spreading to a part of the laboratory.
16	Ignition of organic solvent during experiment	Organic solvent was ignited during an experiment that involved the application of a pulsed laser to an organic solvent in which fine particles were dispersed. In a haste to deal with it with bare hands, the student suffered burns on both hands.
17	Fire due to malfunction of drying furnace	When the drying furnace was operated to remove rust from the reinforcing bars, the temperature-limiting device malfunctioned due to the deterioration of the drying furnace, so the temperature continued to rise and a fire broke out. The tools, electric wires, measuring appliances, etc., on the drying furnace were burned as a result.
18	Puncture injury	During an organic synthesis experiment, the right hand, which was holding an injection needle while trying to conduct delicate work, quivered and the needle stabbed the student's left wrist.
19	Small fire in laboratory	When cleaning an asphalt container, the flame of the stove ignited the waste cloth, and the flame of the ignited waste cloth spread to another waste cloth that was wet with a small amount of kerosene nearby.
20	Fire in chemical heat storage experimental device during experiment	During the heating of oil by a throw-in-type electric heater as part of preliminary preparation for an experiment using a chemical heat storage experimental device, a fire broke out from the oil in the container.
21	Accident in which the thumb was caught between a universal testing machine and a test jig	In the attempt to attach a test jig to the universal testing machine, the portion up to the first joint of the right thumb, which was supporting the test jig, got caught between the jig and the universal testing machine and led to a tear injury of the fingertip.
22	Ignition accident during a heating experiment with cutting oil	When an oil mist evaluation device was used to conduct a capture experiment using cutting oil with a filter, the oil became ignited. No human damage was reported.
23	Hand injury due to breakage of quartz tube while encasing a metal sample in the quartz tube	While attaching the quartz tube to the hose, more force than necessary was applied leading to breakage of the quartz tube and causing a deep cut injury from the base of the left thumb to the base of the index finger.

No.	Accident example	Overview
24	Fire on a weekend night	Fire broke out on and around the lightweight workbench. No human damage was reported.
25	Fire due to mismanagement of experimental waste	When samples that were heated in experiments were discarded without following protocol, the dust in the trash can ignited. No human damage was reported.
26	Contusion wounds of the fingers of left hand while dividing plate-shaped asphalt concrete debris by strike	While smashing the plate-shaped asphalt concrete debris onto the floor outdoors, fingers were caught between the debris and the floor, resulting in contusion wounds.
27	Ignition of tubular electric furnace rubber stopper	While the tubular electric furnace was operating at 1000°C, silicone rubber stoppers at both ends of the mullite tube, which had Ar gas flowing through it, were heated and ignited.

Accident example 1	Solution entered eyes because of not wearing protective glasses during experiment.
Overview	During the process of transferring solution from test tube to glass cell for measurements, a drop that spilled into another beaker of the solution below bounced and got into the eyes of the student. The student was not wearing protective glasses.

1. When

During a student experiment (weekday, around 4:40 p.m.)

2. Where

General chemistry laboratory

3. What kind of accident

At around 4:40 p.m., a first-year undergraduate student was conducting a chemical experiment (experiment theme: colorimetry), in which a mixed solution (cuprammonium solution) composed of an aqueous copper sulfate solution (concentration: 4×10^{-2} mol/L) and ammonia water (8 mol/L), was transferred from the test tube to the measuring glass cell for absorbance measurements. During the transfer, **the solution spilled** and entered the beaker with the cuprammonium solution that was underneath the glass cell. At that time, the cuprammonium solution in the beaker **bounced back and entered the left eye of the student.**

4. How was this handled

The student **immediately washed their eyes with a large amount of water**, and the instructor continued to wash the student's eye with distilled water using a washing bottle for 15 minutes before heading to the hospital.

At around 5:00 p.m., the staff was asked to accompany the student to the hospital, and **water and towels were prepared when the student was sent to the hospital so that they could continue to wash their eyes on the way from university to the hospital.**

At around 6:15 p.m., the physician prescribed eye treatment, eye drops, and oral medicine at the hospital, and the student returned to the university with the staff member.

5. Cause of accident

In the chemistry experiment class for the first-year undergraduates, prior to each experiment, students are instructed to always wear protective glasses as a safety measure during experimentation. Even when going around to observe students during the experiment, instructors always give a warning to students who are not wearing their glasses. **Only the student involved in the accident was not wearing protective glasses**, and they were warned several times. When asking the individual after the accident, the student stated that they were not wearing protective glasses during the accident. This was the main cause of this accident.

On this day, the student had made mistakes in the operation, and they were warned each time. It appeared that the student had not slept enough in preparation for the test, and thus, the student's concentration might have decreased. This might have contributed to the accident.

6. How to prevent this

This is the first accident of its kind in the first-year undergraduate chemistry experiment since the founding of the university. Hence, the accident could not be attributed to the experiment procedure, and **the accident could have been prevented if the student had worn their protective glasses.**

What are protective glasses?



(Note: this is not a photograph of the accident)

Accident example 2	Explosion of experimental equipment
Overview	<p>When a combustible and combustion-supporting gas were mixed and discharged for an experiment to produce fine particles, an explosion occurred inside the device and the acrylic plate lid was blown to pieces.</p> <p>There were no physical injuries due to the explosion, but the student collapsed due to anemia when cleaning up after the accident. The student was injured by hitting the corner of the laboratory table and cutting the forehead.</p>

1. When

During research experiment by graduate student (weekday, around 11:00 a.m.)

2. Where

On-campus joint education and research facility laboratory

3. What kind of accident

During research on the production of ultrafine oxide particles using a fine wire discharge device to control the particle size and structure of nanoparticles that were generated by changing the thermal conductivity of the gas, a graduate student **mixed ammonia and oxygen gas**, and **discharged** it at a total pressure of 0.5 atm. An **explosion** occurred as a result, the acrylic plate that was used as a lid for the device was damaged and scattered, and the fluorescent tube and hand mirror were crushed.

A staff member arrived approximately 20 seconds later, and saw a graduate student walking out of the room. Upon receiving a report from the student about the explosion, it was confirmed that **the graduate student was not injured at this point**. While conducting **post-treatment, such as gas closure and cutting off power supply**, the graduate student **fell to the floor due to anemia, resulting in lacerations and bleeding** as they hit their face against the corner of the experimental device.

4. How was this handled

The staff member **called 119 and the Research Promotion Division** to provide **treatment at the hospital**. An intravenous drip was given due to hypotension, and the laceration was sutured. Blood test results were normal, so the student returned home at 5:00 p.m. the same day.

5. Cause of accident

Because the graduate student **did not recognize that ammonia was a flammable gas and discharged it after mixing it with oxygen, this resulted in an explosion**, and the device was damaged.

6. How to prevent this

(1) Safety education: Conduct safety education. Until now, only lectures were given, so a **test**

that confirmed proficiency was conducted.

- (2) Posting: Instructions on **hazards, flammable chemicals, gases, and their combinations** were posted in the laboratory (Photograph 2).
- (3) Experiment plan: **Consult with an instructor when starting an experiment using new chemicals or gas.**
- (4) Equipment measures: A rupture disk was installed for two large chambers with a volume of over 20 L out of the three devices as a safety valve for releasing internal pressure in a safe direction even in the event of an explosion.
The acrylic flange was replaced with a metal flange that is not prone to brittle fracture.
The gas type was described on the pipe to avoid accidents (Photograph 3).
An acrylic cover was used to prevent an electric shock accident at the exposed part of the wiring.
A red lamp that lights up during charging serves as a warning indicator to prevent electric shocks during charging and discharging. Additionally, a switch that is manually connected between the gap switches was abolished, and an electrically driven remote-controlled discharge switch was installed (Photograph 4).
- (5) Risk assessment: **A risk assessment was conducted. Risk predictions and countermeasures** were also conducted as part of the guidelines.
- (6) Experimental procedure manual: **An experimental procedure manual (equipment manual) was prepared.**

Photograph 1 Device where accident occurred



Photograph 2 Posting of hazards, flammable chemicals, gases, and their combinations



Photograph 3 Display of gas type on pipe

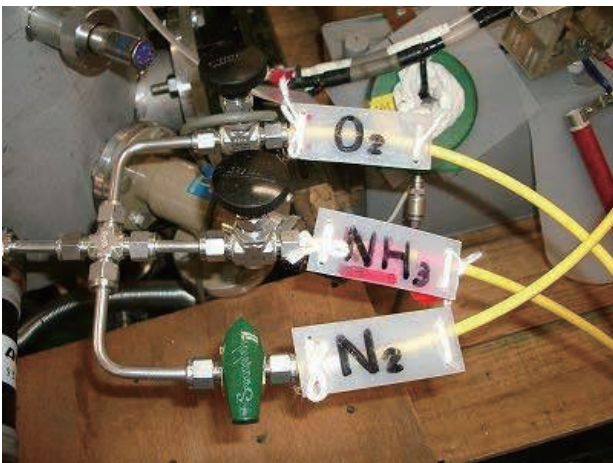

Photograph 4 Remote control discharge switch



Accident example 3	Cutting fingertip with machine tool
Overview	While cutting a large metal plate using a foot-pedal-based cutting machine, the pedal unexpectedly touched the footrest, the blade descended, and an injury occurred—the tips of the middle and ring fingers of the left hand were cut.

1. When

During experimental copper plate processing (weekday, around 2:00 p.m.)

2. Where

Shared-use workshop

3. What kind of accident

A graduate student **cut their fingertips while processing** a copper plate (thickness 1 mm) **by themselves with a foot-pedal-based cutting machine.**

(The student described the incident from the ambulance and after surgery, they said that the blade went down when it was set and their foot touched the foot pedal, but the student was agitated and did not remember the situation well.)

4. How was this handled

The graduate student in question quickly brought their amputated fingers to a nearby laboratory and asked for help.

Two students in an adjacent laboratory were the main responders. **First, 119 was called.** Under the guidance of an instructor in the front room, **the bleeding was stopped; the hand and amputated fingers were waterproofed in a plastic bag, and stored in a bucket that was filled with ice water.** The academic supervisor was also contacted by phone. The academic supervisor contacted the director and headed to the site together. Afterwards, **the Physical Education and Health Center was contacted, a physician and public health nurse rushed over, and treated the student.** The Student Support Division was contacted, and the student’s guardian was contacted.

The student arrived at the hospital by ambulance at around 3:00 p.m. Treatment was started immediately, and an inspection and radiography were conducted. The surgery was started at 4:30 p.m. and ended at around 6:30 p.m.

5. Cause of accident

A foot-pedal-based cutting machine for cutting large metal plates was used to cut samples that measured several square centimeters.

6. How to prevent this

(1) **Investigate a construction method that suits the sample and minimizes risk.**

- (2) In addition to giving education on machine tools in safety education at the time of guidance for student experiments, give specific explanations and alerts to the accident examples that have occurred on campus.
- (3) Post a “Precautions for using the foot-pedal-based cutting machine” in front of the machine.
- (4) Impose strict adherence to the usage time of the shared-use workshop. The workshop is to be used by two people or more at a time for emergency response.
- (5) Modify the device so that fingertips cannot enter the space where the sample is placed in the foot-pedal-based cutting machine.

Foot-pedal-based cutting machine (before improvement)



Foot-pedal-based cutting machine (after improvement)



Accident example 4	Gas leak from gas cylinder
Overview	After completing an experiment using high-pressure gas, the main valve of the gas cylinder was not closed, and the regulator was malfunctioning (when the secondary valve is closed with the main valve open, the gauge indicating the secondary pressure rises and the safety valve opens), so the gas leaked and a foul odor was generated in the laboratory and surrounding rooms. No human damage was reported.

1. When

After research experiment (weekday, around 1:00 p.m.)

2. Where

On-campus joint education and research facility laboratory

3. What kind of accident

Ammonia (NH₃) leaked around the installed experimental equipment, generating a **foul odor** in the laboratory and nearby laboratories.

4. How was this handled

The main valve of the gas cylinder was closed, and the room was ventilated.

5. Cause of accident

An experiment using NH₃ was conducted two days ago. **After the experiment, the main valve of the NH₃ cylinder was not sealed (there was no rule to close it).** An investigation after the accident revealed that the cylinder regulator had a problem where the gauge that shows the secondary pressure increased when the secondary valve was closed without closing the main valve of the cylinder. It is thought that after the end of the experiment, the secondary pressure was gradually increased, and at around 1:00 p.m., approximately 45 hours after the experiment, the safety valve of the regulator was opened, and all the gas leaked out at once.

6. How to prevent this

- (1) **Re-create the experimental work manual, and ensure sealing the main valve of the cylinder and to turn on the exhaust switch of the cylinder cabinet.**
- (2) Dispose the problematic regulator and use a new one.
- (3) Use a cylinder cabinet.

The inside of the cylinder cabinet of Fig. 2 is exhausted by turning on the exhaust switch and discharging the gas to outside. In the future, this cylinder cabinet is to be used,



Photograph 1
Problematic regulator



Photograph 2
New cylinder cabinet

and gas diffusion indoors is prevented even in the event of a gas leak.

- (4) The regulator that was used for NH_3 must be used with NH_3 -compliant products. Because there are potential problems such as due to corrosion, replace this with a space regulator that incorporates new internal parts approximately once a year.

Accident example 5	Ignition from wiring cord
Overview	During electrical and instrumentation work, the cords that were connected to the voltage measuring instrument were bundled and used. This generated heat, melted the coating the device, and resulted in ignition (presumed). No human damage was reported.

1. When

During electrical and instrumentation work (weekday, around 6:00 p.m.)

2. Where

Environment building laboratory

3. What kind of accident

During the electrical and instrumentation work on the laboratory table, a fire suddenly broke out from the power cable of the voltage measuring instrument (Asahi Keiki) that was placed on the laboratory table.

4. How was this handled

Fire-extinguishing activities were conducted to extinguish the fire on the laboratory table using the powder fire extinguisher that was installed in the laboratory immediately after the accident, and the fire was extinguished within one minute.

5. Cause of accident

Heat was generated by bundling and using the long cords that were connected to the voltage measuring instrument, which melted the coating and ignited the material.

6. How to prevent this

- (1) When conducting electrical and instrumentation work for the first time, do it in the presence of technical staff or instructors.
- (2) When connecting the power cable, ensure that it is used according to the conditions and recommendations by the manufacturer.
- (3) When conducting electrical and instrumentation work, move peripheral equipment to another location as far as possible.
- (4) Conduct electrical and instrumentation work with at least two people.
- (5) The power cable should have an appropriate length that matches the distance between the outlet and installation location of the experimental equipment.
- (6) Do not leave the laboratory absent during the experiments.



Site of occurrence (left side: experimental table)

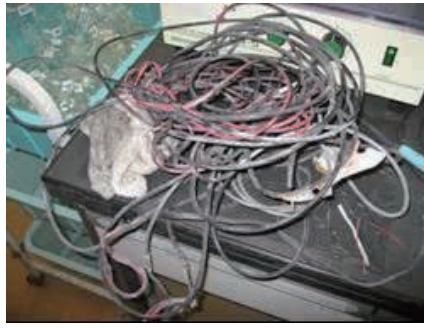

Burnt electrical wiring



Partially burnt voltage indicator

Accident example 6	Accident due to upper plate of experimental device
Overview	The student forgot that the upper plate of the experimental device was hung by a crane, and their head hit the plate causing an injury in the right eyebrow.

1. When

During post-processing of experiment (weekday, around 11:00 a.m.)

2. Where

Large-scale construction experiment building

3. What kind of accident

The student forgot that the upper plate of the experimental device was hung by a crane. As they did not lift it by hand, **they hit the area around their right eyebrow and cut it** while working.

4. How was this handled

The senior colleague that was working together with the student immediately prepared tissues, and the student strongly pressed the tissues on the affected area to **stop the bleeding**, went to the Physical Education and Health Center for first aid, after which they received medical treatment at the Nagaoka Nishi Hospital.

5. Cause of accident

It is thought that the student was **distracted** because of the interest in the experiment.

6. How to prevent this

Do not neglect your attention to surroundings, and work while prioritizing safety.

Accident example 7	Accident during gas filling
Overview	During gas filling, the glass bottle burst, pieces of glass splattered, and approximately 2 cm of the student's left ring finger was cut.

1. When

During research experiment by a graduate student (weekday, around 6:00 p.m.)

2. Where

Environmental reaction engineering laboratory on 4th floor of environmental building

3. What kind of accident

A glass bottle with a capacity of 5 L was **filled with nitrogen gas** for reagent preparation. The glass bottle had a gas inlet and outlet to control the pressure inside the glass bottle. However, the **glass bottle burst** during gas filling, and the glass pieces scattered. As a result, approximately 2 cm of the student's left ring finger was wounded.

4. How was this handled

The student immediately closed the gas cylinder, asked other students in the laboratory to clean up the mess, immediately went to the Nagaoka Red Cross Hospital to treat the wound, and had four stitches sewn in.

5. Cause of accident

The accident was caused by the strong **gas pressure in the glass bottle**.

6. How to prevent this

It is important to properly **check the pressure** when using the gas cylinder, and **ensure a sufficient gas inlet/outlet for gas** to prevent the accident in the future.

Accident example 8	Slipping and falling
Overview	When coming to pick up experimental materials, the student slipped and fell, tearing their chin on the partition block of the material storage area.

1. When

During construction engineering lecture (weekday, around 4:00 p.m.)

2. Where

Concrete laboratory, first floor of machinery construction building No. 3

3. What kind of accident

A fourth-year student of the concrete laboratory was working on a concrete canoe as part of an assignment on the subject “Construction engineering lecture” for the fourth-year construction engineering course that is given in the first semester. On this day, the canoe was developed during the “Construction engineering theme seminar I” for the second-year students of the construction engineering course. The second-year students were touring at the production site and the fourth-year students were explaining the canoe in the presence of the instructor in charge. A student headed to the material storage area in the courtyard to fetch the aggregate for concrete, but **slipped and fell**, and tore their chin on the partition block of the material storage area.

4. How was this handled

Immediately after falling, the student reported to the instructor in charge that they fell and injured themselves, and the student went to the Health Office unaccompanied. Afterwards, a fourth-year student came over to see the injured student’s status. The injured student returned after getting treated with a bandage. In the Health Office, the student was instructed to wait after this treatment. Thus, it was decided that the student should consult a medical institution as soon as possible just in case, and after consulting with the Machinery Construction Office, the student was taken to the Imura Orthopedic Surgical Clinic (Ojimahoncho, Nagaoka City) by the instructor in charge. The physician’s judgment was that there was no need for stitches. The student was treated using antibiotic ointment, and was instructed to visit the hospital the next day.

5. Cause of accident

This accident did not involve any particularly dangerous work or any neglect in attention, but **serious incidents can occur because of even a fall** in the laboratory and material storage area.

6. How to prevent this

Pay close attention to your feet, and give thorough guidance so that you can walk on solid ground without rushing.

Accident example 9	Broken glass trap
Overview	While removing the pressure-resistant rubber tube on the trap inlet side, the liquid inside was suddenly pushed out to the outlet by atmospheric pressure. The force broke the glass trap and caused a shallow cut with a length of approximately 15 cm from the scattered glass pieces.

1. When

During experiment in laboratory (weekday, around 11:00 a.m.)

2. Where

Materials Systems Building No. 2, 3rd floor

3. What kind of accident

Methanol, which is a solvent, was **distilled off under decompression** from the reaction mixture that was placed in a flask. A trap containing an aqueous solution of sodium hydroxide was sandwiched between the flask and water flow pump to prevent the sulfur dioxide gas that remained in the solution from entering the drainage. When the pressure-resistant rubber tube on the trap inlet side was removed partway, the liquid inside was suddenly pushed out to the side of the outlet by atmospheric pressure, and the **glass trap was damaged** by that momentum. The scattered glass pieces inflicted an approximately 15 cm-length **shallow cut** from the side of the little finger to wrist of the right hand.

4. How was this handled

The **wound was immediately washed** with running water, after which the student went to the Physical Education and Health Center and received treatment. The wound was not very deep, so the student only received disinfection and wound protection treatment, resuming the experiment in the afternoon.

5. Cause of accident

The amount of the aqueous solution in the trap was too large and the pressure-resistant rubber tube was suddenly pulled out when the decompression was released, resulting in a **sudden pressure change**. Furthermore, the damaged trap was discarded and could not be confirmed, but there is also the possibility that the “sealing” at the top was scratched for some reason, reducing the mechanical strength.

6. How to prevent this

Do not put too much liquid in the trap. Furthermore, **when releasing the decompression**, use a T-shaped tube and screw cock to **gradually release it**. In addition, instruct this to the students who are conducting similar experiments.

Accident example 10	Cuts caused by cutter grindstone fragments
Overview	When cutting a round iron rod with a fine cutter, the rotating grindstone was damaged and scattered debris, one of which hit the student's head near the right eye and caused a cut of approximately 2 cm.

1. When

During experiment in assignment research (weekday, around 4:00 p.m.)

2. Where

Machinery and Construction Building No. 3

3. What kind of accident

A round iron rod with a diameter of 1 cm and length of 1 m was cut with a fine cutter to cut it to a length of 40 cm. By the time the cutting was finished, the rotating **grindstone was damaged and the debris was scattered**. One piece of this debris hit the student near the right eye and inflicted a **cut** of approximately 2 cm.

4. How was this handled

A senior colleague in the next room immediately noticed and provided a Kimwipe (paper waste cloth), and the student headed to the Physical Education and Health Center while obstructing the bleeding. The student then stopped the bleeding and disinfected the wound with gauze, after which the student went to the Red Cross Hospital. An X-ray was taken to see if there were any foreign substances, and since the bleeding had stopped, the wound was healed without stitching.

5. Cause of accident

Instead of fixing the round iron rod at the proper location, the student held it by hand and cut it.

Therefore, the cover that was installed on the device was not lowered.





Therefore, the cause mishandling of the device caused the accident

6. How to prevent this

- (1) **Thoroughly cover the device** while operating it, and make this known and post this information.
- (2) Instruct the students to **wear protective glasses** as needed.
- (3) Provide guidance and encouragement for the maintenance of machinery and equipment and the arrangement of work rooms.
- (4) When working alone, talk to the surrounding people.

On-site photographs

Machinery and Construction Building No. 3

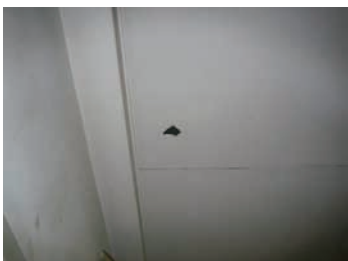
	<p>① Fine cutter that caused the accident</p> <p>A disk-shaped grindstone is attached to the rotating shaft and rotated at a high speed to cut the sample.</p> <p>The grindstone is made of ceramics and is fragile. The thickness of the grindstone is approximately 0.5 mm.</p> <p>The iron cover is equipped with an acrylic lid.</p>
	<p>② When an iron cover is placed and the acrylic lid is opened.</p> <p>Rust is present on the bolts of the metal fittings that fix the material.</p> <p>There are no notes around the device that instructs the user to “cover.”</p>
	<p>③ When the iron cover and acrylic lid are closed. Used this way when cutting.</p>
	<p>④ When the accident occurred, the work was done by one student, and the cover was lowered.</p> <p>The student was from a technical college and has experience working in the machining center of the university, so the student was familiar with the machine.</p>
	<p>⑤ Acrylic lid</p> <p>Difficult to see inside because of dirt.</p> <p>Also, there is no lighting near the hand placements, making it difficult to understand the work location.</p>
	<p>⑥ Fragments of the grindstone that had broken and scattered were stuck in the ceiling directly above the machine.</p>

Accident example 11	Acetone ignition due to overheating of hot plate
Overview	A powder obtained by mixing titanium powder, hydroxyapatite powder, and a small amount of acetone was put into a metal plate and heated on a hot plate, whereupon the acetone ignited and generated a fire.

1. When

During experiment in research activities (extra-curricular/weekend, around 2:00 p.m.)

2. Where

Experimental training building No. 2

3. What kind of accident

When a powder mixed with titanium powder, hydroxyapatite powder, and a small amount of acetone was put into a metal plate and heated on a hot plate, the **acetone ignited**, and generated a flame. The accident occurred 10 minutes after the commencement of the experiment. After confirming the absence of abnormalities by observing the circumstances in the first five minutes, the student organized the materials in an adjacent room. Another student visited the laboratory for another purpose, and discovered a small flame.

4. How was this handled

The discoverer first tried to extinguish the fire by covering it with an iron container but was unsuccessful, then the fire was extinguished using a **fire extinguisher** that was installed outdoors.

5. Cause of accident

(Factors during work)

- (1) The possibility that acetone would catch fire was recognized. But the student did not expect a problem during the process, and **left the scene**. Therefore, the student was unable to detect the **overheated state** prior to ignition.
- (2) The student conducted the experiment without **sufficiently confirming the work procedure and risks** with other people. There is also the possibility that the student hesitated to **contact instructors** because it was a weekend.

(Background factors of the system)

- (1) The hot plate was not equipped with an overheating prevention device.
Even though this factor may have contributed to the accident, it is presumed that the factors during the work may had a pivotal effect on the occurrence of the accident.

6. How to prevent this

- (1) When using acetone during wet mixing, **it should be sufficiently evaporated in a hot water bath** before drying. The experimentalist should be instructed to **monitor whether overheating occurs** until the end of the work.
- (2) Students should be reminded that, even when working on weekends, **they should plan proper**

work procedure and consult the instructors prior to the weekend, take measures after the safety evaluation, receive approval, and then conduct the work.

Reference on-site photographs



State of hot plate and surroundings that caused the overheating.
The ignition occurred on the metal plate in the figure.



Hot plate controller.
Only the timer and strength of the device can be controlled.

Accident example 12	Rupture of glass chemical bottle during etching process
Overview	When the waste liquid of an etching solution that was separately prepared with different concentrations of nitric acid and hydrochloric acid was mixed in a glass bottle and its lid was closed, the bottle burst and scattered, damaging the front glass of the fume hood.

1. When

During experiment in research activities (extra-curricular, weekday, around 2:00 a.m.)

2. Where

Machine construction building No. 2 (Chemical treatment room)

3. What kind of accident

A student was creating an etching solution, by mixing nitric acid and hydrochloric acid, to **etch a stainless steel material**. Separately prepared etching solutions with different concentrations were mixed into a glass bottle and covered with a lid, after which the **bottle burst and scattered**, and the front glass of the fume hood was damaged. Furthermore, the left thumb of the student was injured due to a piece of the scattered glass.

4. How was this handled

The student **provided a verbal notification to a laboratory student** in the adjacent room, and requested a report to the Energy Center through the emergency contact network. After the Energy Center confirmed the accident site, the student, along with other students in the laboratories on the same floor, went to Nagaoka Chuo General Hospital and had a medical examination. Examinations showed that there were no abnormalities other than the **injury on the tip of the left thumb of the student**.

5. Cause of accident

The student was using the etching solutions with different concentrations for the first time, and they did not **sufficiently consider the danger** of developing further reactions by mixing the waste solutions. As a result, when the lid was covered during the reaction, the glass bottle ruptured.

6. How to prevent this

- (1) Do not mix waste solutions of etching solutions that were prepared separately into the same glass bottle.
- (2) **When mixing chemicals, sufficiently check** whether a reaction will occur, and if a reaction occurs, whether the subsequent reaction is stable.
- (3) Remind the students to **create plan procedure and consult/confirm with the instructor in advance when working at night**, take measures after safety evaluation, receive approval, and then conduct the work.
- (4) The student tried to contact an instructor via the mobile phone, but could not reach them. In the

future, **double-check the contact information** of all associated instructors, including their home phone numbers.

- (5) Following the guidance of the academic supervisor, the student wore a lab coat, scarf that doubled as a mask, hat, protective glasses, and acid-resistant gloves, and conducted work in the fume hood. Therefore, there was no damage from the chemicals, but only the fingertips that were injured by the glass pieces. In the future, ensure the same guidance.
- (6) After reviewing the work procedure in the laboratory, an **external inspection and evaluation** should be conducted, and a safe procedure will be implemented as needed.

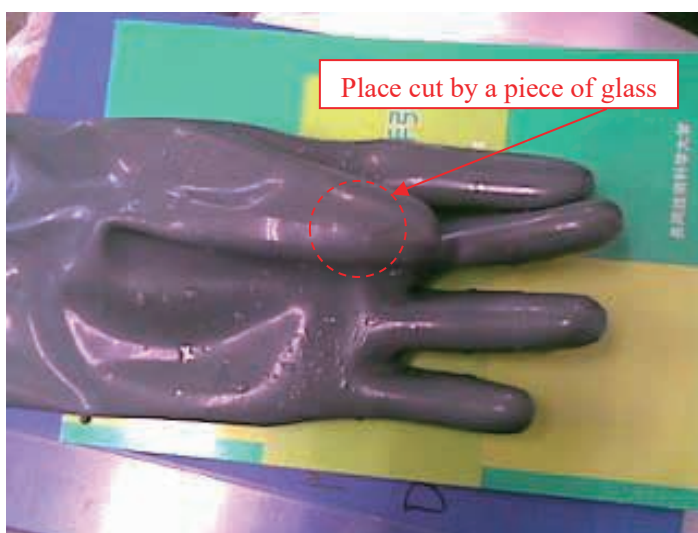

Acid-resistant gloves worn at the time of accident



Student's injury (a cut on the thumb of left hand)
There were no injuries other than the thumb because the student had worn protective glasses, gloves, and a lab coat.



Fume hood after accident
The front glass was damaged because the glass bottle burst inside the fume hood.

Accident example 13	Getting caught between sample and fixed vise.
Overview	When attempting to fix a semi-cylindrical metal material to the base of a band saw cutting machine with a vise to cut it, the left thumb holding the material was placed between the vise and material was caught.

1. When

During sample processing for experiment (weekday, around 4:30 p.m.)

2. Where

Work center

3. What kind of accident

A student was trying to cut a semi-circular metal material with a diameter of 175 mm and thickness of 55 mm into a size that fits into a melting pot. While using a band saw cutting machine and attempting to fix the material to the table of the machine with a vise, the left thumb holding the material was pinched.

4. How was this handled

Immediately after the accident, the student reported it to the staff of the work center, and the bleeding was stopped. After receiving the report, the staff of the Physical Education and Health Center came and performed first aid with disinfection, gauze, and bandages, after which the student headed to Tachikawa General Hospital at 4:40 p.m.

5. Cause of accident

Normally, when fixing a semi-circular material to the table of a band saw cutting machine, the material is placed on the table with the flat surface of the semi-circle facing down. However, as the material was placed on the table with the arc side facing down, it became unstable, and as a result, the student placed their hand on the material.

Furthermore, the student was a special auditing student from a foreign country and had no experience working with similar equipment. For the first 30 minutes of the work, a first-year master's student operated the machine and gave guidance while showing a model of a series of operations using this machine. Afterwards, the student in question conducted the work while the first-year master's student checked the operations for approximately two hours, but the accident occurred when the master's student looked away for a moment.

6. How to prevent this

- (1) Reinforce the confirmation of advance safety guidance from the academic supervisor.



Provide a "safety guidance completed mark" column from the academic supervisor on the usage application form.

- (2) Tighten the attendance of safety training sessions.

Prohibit the use of devices unless the person has conducted the beginner's training for each device.

Post "Usage guidelines" and "prohibited matters" for each device, and have students understand the safety precautions prior to use.

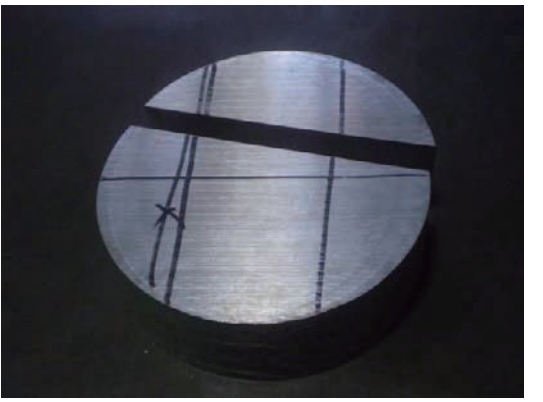
- (3) Conduct risk assessments on equipment owned by the work center to strengthen safety measures.

	<p>① Tsune Seiki band saw cutting machine where accident occurred</p> <p>Exterior photograph of TB4-262GN</p> <p>This is a cutting machine for cutting large samples such as metal.</p> <p>The material is pinched with the hydraulic cylinder-type main vise A and fixed, after which the sample is cut.</p>
	<p>② Metal material that was planned to be cut in this experiment</p> <p>Sample dimensions: Diameter 175 mm Height 55 mm</p>
	<p>③ At the time of the accident, the person (user) placed the semi-circular material with the arc side down as shown in the figure on the left, put their hand on the material, and tried to fix the vise so that the material would not move.</p>
	<p>④ The student pressed the “close” button of the main vise when fixing the material manually, with the left thumb inserted between the main vise and material; consequently, the left thumb was pinched.</p> <p>The first-year master’s student who was next to the student noticed the accident, pressed the open button on the main vise to remove the load, and reported it to the staff at the work center.</p>

Accident example 14	Chemical burns caused by concentrated sulfuric acid
Overview	A beaker, which contained a strongly oxidizing solution, slipped out of the hands of a student and broke, and the solution spilled on the student's limbs.

1. When

During a research experiment in the laboratory (weekday, around 1:00 p.m.)

2. Where

On-campus joint education and research facility laboratory

3. What kind of accident

A fourth-year undergraduate student accidentally dropped a beaker (500 ml) that contained concentrated sulfuric acid and a small amount of potassium nitrate. The beaker broke in the draft, with the solution spilling on both the hands and feet of the student. The affected area turned yellow due to the reaction between the nitric acid and protein.

4. How was this handled

The student immediately washed the exposed part with running water. Afterwards, a shower head was attached to a hose outdoors and used to wash the student with running water. The student was transported to the hospital and treated by a physician. The doctor allowed the experiment to resume the next day, and the wound was completely healed after three days. This did not become a severe incident because a large amount of running water was used to wash the affected area immediately after the solution came into contact with the skin.

5. Cause of accident

Because the student rushed the experimental operations, they tried to lift the beaker that was covered with cling film by the top of the beaker. This caused it to slip out of the student's hand. Instructions were to handle this with gloves, but the student did not follow this rule.

6. How to prevent this

The student should wear chemical-resistant gloves and hold the beaker firmly from the side. The student should concentrate on the operation during the experiment, and ensure that it is done carefully. The student should wear safety glasses to protect the eyes. An operating procedure manual that included possible dangers was already posted, but this will be improved to make it more visible.

If such an incident occurs again in the future, washing the affected area with a large amount of flowing water as quickly as possible is effective and important.

Accident example 15	Fire caused by forgetting to turn off power supply
Overview	The heater in the plastic bucket was overheated, the water in the bucket evaporated and became “empty,” the heat of the heater ignited the plastic, and the fire spreading to a part of the laboratory.

1. When

Weekend, around 10:30 a.m.

2. Where

Doctoral experiment building, 3rd floor

3. What kind of accident

The water around the heater that was installed in the plastic water tub, which was part of the water treatment experimental equipment, evaporated and became empty”. The plastic burned in flames under the effect of heat. There was nothing flammable around the device, but this melted the plasterboard ceiling, and there was damage to two fluorescent lights, a ceiling speaker, test device body, and a laboratory table with a sink.

The test device body had been inactive for six days prior to the completion of the experiment by the master’s student. The heater (power consumption 1 kW) was energized and the temperature in the laboratory dropped, so it was thought that the heater thermostat was activated, the water in the water tub gradually decreased, and became empty. The thermostat was set to operate when the water temperature dropped below 28 °C.

4. How was this handled

An energy center staff member who rushed to the site owing to the fire alarm discovered the fire and extinguished it using a fire extinguisher (one extinguisher used). The energy center staff member reported to the executive office staff and contacted the instructor in charge. The fire broke out on a weekend, and the person in charge of the experiment was absent.

5. Cause of accident

(Artificial factors) When putting a device out of operation, the power supply of the heater needs to be cut (i.e., unplug from the outlet), but the student forgot to turn the heater off.

(System factors) The heater did not have an emptying prevention function.

6. How to prevent this

- (1) Hold safety and health meetings in the laboratory as soon as possible, and thoroughly implement management and operation methods after considering risk countermeasures for equipment, including heat sources.
- (2) When putting the device out of operation, ensure that the power supply of the device that generates heat (e.g., heaters) are also turned off. We will post operation manuals, instructions, etc., in a noticeable location.
- (3) Install a device that automatically turns the heater off when the water level drops and a device that stops the heating function when the container is empty.

7. Other

- (1) Presence or absence of SDS creation of device: absent (because there was no legally managed object).
- (2) Presence or absence of experimental manual in environment/construction system and presence or absence of

experiment safety guidance implementation. Experiment safety guidance for all students were conducted at the beginning of student experiments in the 3rd year of the environmental systems engineering course using safety guides, videos, etc. However, the water treatment test device in this incident originally involved the development of the device, and there was no manual for the test device.

Burned test device: black container in middle is plastic water bucket



Fluorescent ceiling lamp



Plastic cover of ceiling speaker that was melted with heat



Accident example 16	Ignition of organic solvent during experiment
Overview	Organic solvent was ignited during an experiment that involved the application of a pulsed laser to an organic solvent in which fine particles were dispersed. In a haste to deal with it with bare hands, the student suffered burns on both hands.

1. When

During experiment in laboratory (weekday, around 11:50 p.m.)

2. Where

Machinery building No. 2, 7th floor (Laser application laboratory)

3. What kind of accident

A first-year student in the Department of Electrical and Electronic Information Engineering:

- ① started an experiment where an organic solvent (propanol), in which fine particles were dispersed, was placed in a 100-cc beaker, to which a pulse laser (KrF, 248 nm, ~120 mJ) was irradiated (in-liquid laser ablation).
- ② After the start of the experiment, the vaporized organic solvent ignited for some time, and a pillar of fire rose for a moment.
- ③ The student attempted to carry the beaker to the sink in a hurry with their bare hands but could not stand the heat and dropped it away.
- ④ The blackout curtain ignited, but there was no damage due to the use of fire protection. A nearby cushion was slightly burned. Organic solvent was spilled on the student's hands, ignited, and resulted in burns on both hands.

4. How was this handled

A fire alarm went off, and the student in question who came out of the laboratory was discovered by a student from another laboratory, and they requested an ambulance. The mechanical system instructor also confirmed the fire alarm and notified the emergency contact network. The student was taken by ambulance to Tachikawa General Hospital, where they underwent examinations and returned to the laboratory.

The fire department arrived and confirmed the site; the next day, the fire department and police verified the site.

5. Cause of accident

Prior to the accident, experiments were conducted using water. The academic supervisor was planning to conduct experiments by mixing propanol and water in the future when experiments did not progress well with just water, but the student conducted the experiment with propanol (100%). The student conducted the experiment alone late at night, and furthermore, was agitated by the pillar of fire, and was unable to take appropriate measures, such as extinguishing the fire by covering the beaker.

6. How to prevent this

When conducting experiments that could be dangerous after 21:00, make sure to sufficiently plan with the academic supervisor, and a notification of remaining after hours should be submitted. When conducting the

experiment, the academic supervisor should be present with the student to conduct the experiment, or alternatively, experiments should be conducted with two or more students. When conducting experiments with just students, the academic supervisor should always be reachable by phone.



Beaker (recreating scenario of the accident)



Ignited cushion

Accident example 17	Fire due to malfunction of drying furnace
Overview	When the drying furnace was operated to remove rust from the reinforcing bars, the temperature-limiting device malfunctioned due to the deterioration of the drying furnace, so the temperature continued to rise and a fire broke out. The tools, electric wires, measuring appliances, etc., on the drying furnace were burned as a result.

1. When

During experiment in laboratory (weekday, around 12:00 a.m. – 4:00 a.m.)

2. Where

Large-scale experimental building

3. What kind of accident

In order to remove rust from the reinforcing bars, a 10% aqueous diammonium citrate solution and reinforcing bars were placed in a plastic container and placed in a drying furnace that was set to 60 °C. Due to the deterioration of the drying furnace (made in 1975), the temperature limiting device was malfunctioning, and the temperature continued to rise, so a fire broke out either inside the furnace or near the exhaust port, resulting in the burst of tools, electric wires, measuring appliances, etc., that were on the drying furnace. There were few combustibles in the surrounding area, so the fire was extinguished spontaneously, and only the drying furnace and the items above it were burned.

4. How was this handled

The fire broke out in the middle of the night, and there was nobody in the room. A patrolling energy center staff member discovered smoke in the hallway of the second floor on the Machine Building No. 1, checked the surroundings, and found the location of the fire on the same day. The fire was already extinguished at this stage. Afterwards, the faculty and staff confirmed the situation, saw that the breaker of the burnt distribution panel was turned off, and there was no risk of a second fire.

5. Cause of accident

(Equipment factors)

The drying furnace was deteriorated, and the temperature limiting device was malfunctioning.

(Environmental factors)

There were combustible items on the device.

(Human factors)

Two days before the fire, another student conducted the same work, and there was an incident where the plastic container, which usually does not have any problems, had melted, and deformed. The possibility that the device is malfunctioning should have been confirmed at this stage, but the student did not contact the instructor and left this alone.

6. How to prevent this

- (1) Inspect similar equipment.
- (2) Do not place any combustible items around a device that may generate heat or catch fire.
- (3) When a device malfunctions or exhibits abnormalities, immediately cease its use, contact the faculty and staff, confirm the cause, and take the proper measures. Inform all laboratory users on these aspects.



Burnt drying furnace

Accident example 18	Puncture injury
Overview	During an organic synthesis experiment, the right hand, which was holding an injection needle while trying to conduct delicate work, quivered and the needle stabbed the student's left wrist.

1. When

During experiment in laboratory (weekday, around 5:00 p.m.)

2. Where

Environmental system building

3. What kind of accident

When conducting an organic synthesis experiment, the student accidentally stabbed their left wrist with an injection needle.



Affected area that was swollen due to internal bleeding

4. How was this handled

As the bleeding quickly stopped at the time of the accident, the student decided that a bandage would be sufficient. However, perhaps due to unconsciously scratching the affected area because of itchiness, the student exhibited swelling due to internal bleeding the following week; hence, the student visited the Physical Education and Health Center for medical examinations.

5. Cause of accident

This was considered to be due to tremors caused by nervousness when attempting delicate work, thus causing trembling of the right hand that held the needle.

6. How to prevent this

The laboratory should be informed of the dangers of using injection needles in experiments and ensure safe handling. Additionally, thorough guidance should be given to the effect of even minor accidents and injuries in the laboratory, and such damages should be immediately notified to instructors in the laboratory. The instructors should provide the necessary measures. Students should be thoroughly informed on the storage location of emergency supplies that are needed for first aid, such as disinfectants and bandages.

Accident example 19	Small fire in laboratory
Overview	When cleaning an asphalt container, the flame of the stove ignited the waste cloth, and the flame of the ignited waste cloth spread to another waste cloth that was wet with a small amount of kerosene nearby.

1. When

During experiment in laboratory (weekday, around 11:52 a.m.)

2. Where

Machine construction building No. 4

3. What kind of accident

Cleaning the asphalt container involves heating the container with an open flame of a stove to reduce the viscosity of the adhered asphalt and then wiping it with a waste cloth. During this time, the waste cloth touched the flame of the stove, thereby igniting the waste cloth. The flame of the ignited waste cloth then spread to another nearby cloth that was impregnated with a small amount of kerosene. As a result, the waste cloth and the worker's work gloves were burnt, smoke was generated, and the fire alarm was activated.

4. How was this handled

The burning of the waste cloth was minor, so the student shook it with their hands to extinguish the fire. The student was wearing two work gloves and was able to extinguish the fire manually.

5. Cause of accident

The fire was generated by cleaning using a waste cloth and leaving a waste cloth that contained kerosene.

6. How to prevent this

Ensure that the waste cloth with kerosene is separated from the waste cloth without kerosene and stored in an appropriate position. Additionally, do not heat and clean the asphalt container with a flammable material nearby, let alone a waste cloth that is impregnated with kerosene.



Asphalt container, stove, and waste cloth



Setting of the room when the fire occurred

Accident example 20	Fire in chemical heat storage experimental device during experiment
Overview	During the heating of oil by a throw-in-type electric heater as part of preliminary preparation for an experiment using a chemical heat storage experimental device, a fire broke out from the oil in the container.

1. When

During experiment in laboratory (weekday, around 2:25 p.m.)

2. Where

Shared-use laboratory building

3. What kind of accident

As part of preliminary preparation for an experiment using the chemical heat storage experiment device, a student was heating oil (flash point of approximately 220 °C) in a throw-in type electric heater. The experiment that should normally be conducted by two people was conducted by one person, and the student momentarily left the scene while the oil was heating up to the target temperature of 120 °C. When the student returned to the scene, a fire broke out from the oil in the container where the electric heater was installed.

4. How was this handled

A permanent fire extinguisher was used to extinguish the fire around the device, the power breaker was turned off, and the laboratory shutter was opened for ventilation. Furthermore, fire extinguishing activities were conducted with another individual who came to help, and the fire was extinguished 5 minutes later from discovery. Afterwards, the fire department was notified.

5. Cause of accident

(Device factors)

The electric heater was immersed from the top of the container that contained the oil, so it is possible that the oil that was heated above the flash point by the electric heater rose along the surface of the electric heater, touched the air, and ignited.

(Work method factors)

An experiment that should normally be conducted by two people was conducted by one person, and the student left the scene while heating the oil.

6. How to prevent this

(1) For the device, an oil stirring bypass route should be installed and the oil should be constantly circulated by a circulation pump to minimize the temperature unevenness of the oil in the container. Set the circuit such that it does not turn on the electric heater if the circulation pump is not operating. Additionally, install a temperature raise prevention device that turns off the electric heater when an abnormal value is detected by the installed multiple temperature sensors.

- (2) Do not leave the scene during experiments, and constantly monitor the oil temperature.
- (3) Regularly review the experiment manual and keep it on site.



Container in which oil was heated with the electric heater (after the fire was extinguished)



Electric heater that was installed in the container that contained oil

Accident example 21	Accident in which the thumb was caught between a universal testing machine and a test jig
Overview	In the attempt to attach a test jig to the universal testing machine, the portion up to the first joint of the right thumb, which was supporting the test jig, got caught between the jig and the universal testing machine and led to a tear injury of the fingertip.

1. When?

This occurred while conducting an experiment in the laboratory (Saturday, around 1:15 p.m.)

2. Where?

In a shared-use experiment building

3. What kind of accident occurred?

A student in the Materials Engineering Department was trying to support a test jig with the right thumb to attach the jig to the universal testing machine. The student moved the mounting movable part downward when the half of the first joint of the right thumb got caught between the two devices.

The victim was working alone when the accident occurred; the tip of the right thumb tore apart, the bones were visibly crushed, and the nail came off.

4. How was this handled?

The mounting movable part was moved upward immediately on realizing that the right thumb was caught.

The wound was bandaged with a clean cloth, after which the victim went to the Nagaoka Red Cross Hospital and received treatment.

5. What was the cause of the accident?

In order to reduce the work time, the procedure followed was different from the instructions mentioned for jig mounting.

6. How can this be prevented?

- (1) Follow the instructions correctly for the procedure as mentioned when doing the work.
- (2) Attach the jig mounting procedure chart to the testing machine body to prevent mounting by the wrong method.

[Circumstances at the time of the accident]

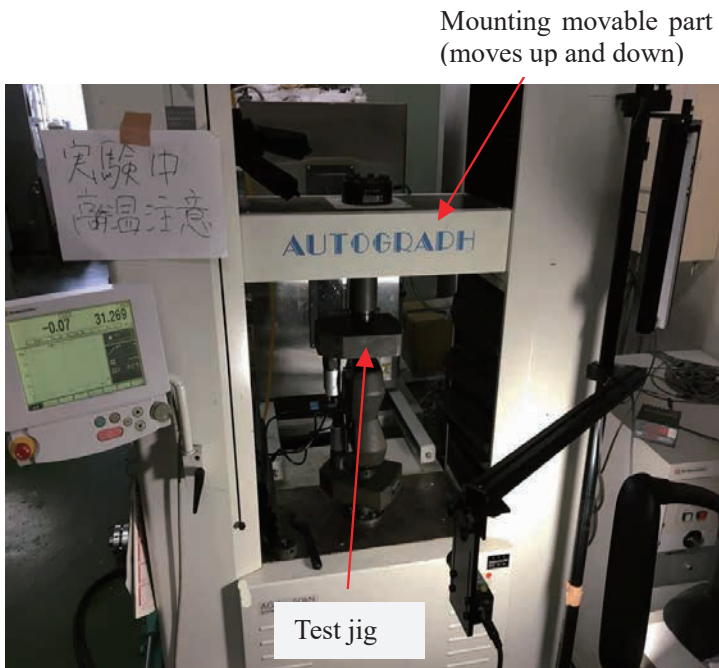

Photo 1 Photograph of the universal testing machine



2. Position to support the test jig

① Alignment markers were included so that the universal joint and set pin of the upper jig could be easily inserted, and a spacer for height adjustment was attached to the upper jig (Fig. 1). As a result, the lower surface of the universal joint and upper surface of the spacer could be moved up instantly prior to contact, and it was confirmed that the set pin could be easily inserted if the alignment markers are matched.

② The procedure was changed so that the installation of the upper jig was done before the lower jig was attached in order to prevent the jig from falling when attaching to the upper jig. The upper jig was placed on the lower table (Fig. 2) and connected to the universal joint, after which the upper table was moved upward and the lower jig was attached, which enabled the safe connection of the upper jig and the universal joint.

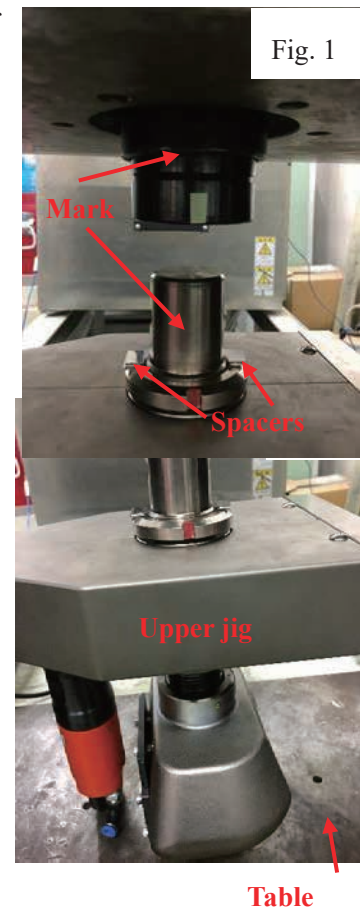

Accident example 22	Ignition accident during a heating experiment with cutting oil
Overview	When an oil mist evaluation device was used to conduct a capture experiment using cutting oil with a filter, the oil became ignited. No human damage was reported.

1. When?

During an experiment in the laboratory (weekday, around 2:00 p.m.)

2. Where?

In the Materials Building No. 2

3. What kind of accident occurred?

A third-year undergraduate student was conducting an experiment all by him/herself. Cutting oil (Yushiroken GTS-100, flash point 150°C) was poured into a glass petri dish (22 cm diameter x 5 cm height) in the oil mist evaluation device and heated to a temperature of 110°C using a thermal link electric stove, which led to the oil becoming ignited and caused a fire. The evaluation device is built in such a way that the oil mist in the oil heating section is sucked through the duct pipe by a blower and guided to the filter section. The objective of the experiment was to capture the oil mist generated by this process using a filter. During suction with a blower, fire occurred approximately 10 minutes after heating commenced. Fire broke out at a temperature of 110°C, as seen from the measurement on the thermocouple at this time.

4. How was this handled?

As soon as the fire broke out, another student entered the room, and the two of them tried to extinguish the fire with a fire extinguisher, but they were unable to pull out the safety pin and operate the fire extinguisher properly. Later, with the help of some of the staff on the same floor, the fire was extinguished using a fire extinguisher. At almost the same time as the start of the fire, the fire alarm went off and announcements for safety began through voice guidance throughout the building. On hearing these, another staff member came and evacuated the students in question as well as other students on the same floor. Smoke from the combustion of the cutting oil and equipment parts filled the room, and the acrid odor of burning oil drifted down the hallway. Staff members split themselves into groups quickly evacuated faculty and students on the other floors and led them outside to safety. They then conducted on-site confirmations while opening the windows and waited for the smoke and odor to subside. The facility staff contacted the Nagaoka Fire Department, after which an investigation and inspection were conducted by the fire department.

5. What was the cause of accident?

The instructions were that heating should be gradual and that high temperatures should not be attained.

However, to capture a large amount of oil mist with the filter, the student conducted the experiment under rapid temperature rise settings.

The experiment calls for oil to be poured into a tin can and heated, but the student changed the specifications of the device at his/her own discretion, poured oil into a petri dish made of ordinary glass, and heated it. It is possible that oil may have leaked through a crack in the petri dish and caught fire at the thermocouple section.

The student panicked as soon as fire broke out and was unable to operate the fire extinguisher to put out the fire.

6. How can this be prevented?

- (1) Do not conduct experiments alone.
- (2) Do not conduct experiments based on expectations and implement changes in device specifications.
- (3) Do not panic in the event of an accident.

[Site photographs]

As shown in the oil mist evaluation device 3, the developed filter is contained in the cylindrical part on the left side, and the oil mist that is generated in the oil heating part is guided to the filter through the aluminum duct tube above the suction section by the blower on the far right. After the accident, the glass petri dish was broken, as seen from the photograph of the oil-heating part and the oil-receiving part, and the oil that was spilled from the oil-receiving part was accumulated in the lower part of the jack around the oil-heating part.



Oil mist evaluation device 1



Oil mist evaluation device 2



Oil mist evaluation device 3



Oil-heating part



Damaged oil-receiving part



Around the oil-heating part

Accident example 23	Hand injury due to breakage of quartz tube while encasing a metal sample in the quartz tube
Overview	While attaching the quartz tube to the hose, more force than necessary was applied leading to breakage of the quartz tube and causing a deep cut injury from the base of the left thumb to the base of the index finger.

1. When?

During an experiment in the laboratory (weekday, around 1:00 p.m.)

2. Where?

In Machinery / Construction Building No. 3

3. What kind of accident occurred?

A student in the Mechanical Engineering Department was conducting an experiment that required a metal sample to be placed within a quartz tube. The contents within the tube were drawn out and vacuum sealed. When connecting the quartz tube with a diameter of 20 mm (outer diameter of approximately 23 mm) to a hose with an inner diameter of approximately 22 mm that was connected to a rotary pump, the student tried to force the tube into place. The quartz tube broke, and the student's left hand sustained a deep gash around five cm long (from the base of the thumb on the back of the hand to the base of the index finger) and started bleeding.

4. How was this handled?

The student tried to stop the bleeding on the way to the first aid block in the physical education and storage center; soon the nurse on duty helped stop the bleeding. The student then went to Nagaoka Red Cross Hospital along with the academic supervisor and was immediately treated at the emergency outpatient department. Since the student's thumb tendon and artery were cut, the student was hospitalized immediately. Following surgery at 5:00 p.m., the student was hospitalized for two nights for follow-up observations.

5. What was the cause of the accident?

Normally, the hose is inserted into the quartz tube or removed from it by applying vacuum grease so that it slips into position or detached easily from the tube. However, the student was not aware of this and tried to fix the quartz tube to the hose using force. At the time of the accident, no vacuum grease was placed around the experimental equipment.

The inner diameter of the quartz tube was large (20 mm) to suit experimental conditions, and the hose wall thickness used was too thick, while the inner diameter of the hose was too small. Risk assessment at the time of changing the experimental conditions was not conducted.

6. How can this be prevented?

- (1) Conduct safety checks and work according to the instructions given in the procedure chart.
- (2) Post the precautions for the experiment in the immediate vicinity of the sealing worksite.
- (3) Provide safety instructions as a way of warning whenever a new student is assigned.
- (4) Place the items necessary for the experiment (i.e., protective glasses, gloves, face shield, vacuum grease) in designated positions right next to the sealing worksite.
- (5) Use appropriate protective equipment depending on the experimental technique and risk such as a standard-compliant product (ANZI Z87, Class 1, etc.) for protective glasses and cut-resistant gloves (EN388 Level 5).
- (6) Conduct risk assessment, explain the importance of risk prediction, and take precautions against possible danger.

[Circumstances at the time of accident, measures]



Connecting quartz tube to hose

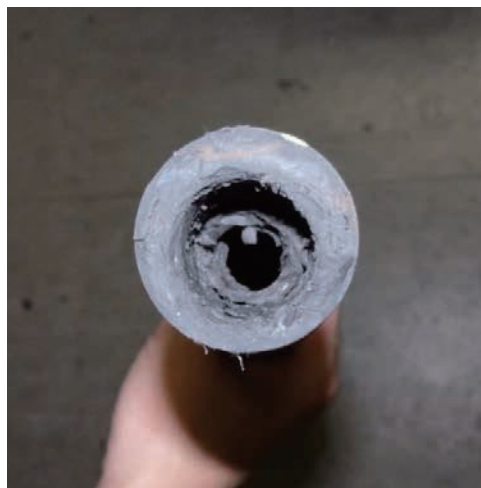

Inside of the vacuum hose



Place items required for the experiment in the immediate vicinity of sealing worksite

Accident example 24	Fire on a weekend night
Overview	Fire broke out on and around the lightweight workbench. No human damage was reported.

1. When?

During an experiment in the laboratory (weekend night, around 12:10 a.m.)

2. Where?

In Machinery / Construction Building No. 2

3. What kind of accident

While the equipment was operational and unattended all night, a fire broke out, which burned items on and around the lightweight workbench.

The device that was operating unattended was not connected to the extension cord set, which is presumed to be the source of the fire.

The magnetic stirrer that was connected to the desktop drafter and the extension cord set on the lightweight workbench were non-functional at the time of the fire.

4. How was this handled?

A staff member of the university who rushed to the scene when the fire alarm sounded reported the incident to the fire department. A security guard of the university brought a fire extinguisher to the scene, but the fire could not be extinguished due to the strong smoke and heat.

A room on the same floor had lights on, and hence, the staff member went around to announce the outbreak of fire. However, the room was empty; perhaps the persons in it had already evacuated. Fire extinguishing activities were conducted by the fire brigade, and the fire was extinguished an hour and 20 minutes after it fire broke out.

On-site inspections were conducted by the fire department and police on the morning after the fire.

5. What was the cause of the accident?

On-site inspections by the fire department, police, and forensics revealed that the extension cord set placed on the lightweight workbench burned violently, and that something on the lightweight workbench caught fire due to electrical factors. The fire that started from the extension cord set may have been high. Although it could not be definitively concluded whether it was the extension cord set itself or a device that was connected to the extension cord set at the time that caused the fire, it was speculated that the problem lay with one of these two devices. The cause was not specified, but possibilities included the heating of the tracking or AC adapter.

6. How can this be prevented/

- (1) Attach a safety cover to the plug in order to prevent tracking.
- (2) Attach an outlet cap to empty outlets in order to prevent dust from gathering.
- (3) Further, use a storage box if there is no choice but to place the power strip in a place where a large amount of dust can gather.
- (4) Pay attention to the power consumption of the connected device in order to avoid exceeding the cable capacity.
- (5) Regularly inspect outlets, extension cords, etc., and replace all extension cord sets with products that have the “PSE” mark or are PSE “compliant”.
- (6) Make sure to unplug unused devices.

[On-site photographs]



Small electric furnace that was in operation at the time of the fire



Location of fire (after removing lightweight workbench)



Extension cord set that was presumed the source of the fire



The desk drafter (almost burned down) that was installed on the lightweight workbench and the magnetic stirrer that was installed on the desktop drafter (power supply is connected to the extension cord set on lightweight workbench)

* Not in operation at the time of the fire.



Lightweight workbench on which equipment that was presumed the source of the fire was placed

Accident example 25	Fire due to mismanagement of experimental waste
Overview	When samples that were heated in experiments were discarded without following protocol, the dust in the trash can ignited. No human damage was reported.

1. When?

During an experiment in the laboratory (weekday, around 2:00 p.m.)

2. Where?

Experimental Training Building No. 2

3. What kind of accident occurred?

A graduate student and an undergraduate student from the Department of Mechanical Engineering dumped biomass (sugarcane) that was heated during an experiment into the trash can after cooling it in air, which led to a fire. The combustible waste in the trash can was ignited due to insufficient cooling.

4. How was this handled?

A university staff member who passed by the site saw smoke coming out of the trash can that was covered with a lid. On opening the lid, it was seen that a part of the paper and cardboard waste in the trash can was on fire. Hence, water was quickly sprinkled on it to extinguish the fire.

5. What was the cause of the accident?

Normally, after a heating experiment, biomass is transferred to a stainless steel container, cooled in air for approximately 15 minutes, sprinkled with water to douse any remnants of fire or heat, and then discarded as general combustible waste.

In this case, considering the danger of sprinkling water on biomass, which was at a high temperature of over 100 °C, and the hassle of drying the wet biomass, an on-site decision was taken to cool the biomass in the stainless steel container and discard it without extinguishing the fire with water. The decision was taken based on the fact that the biomass in the stainless steel container had no flame or red heat (high-temperature light emission), and that the stainless steel container walls were about the same temperature as room temperature. However, the temperature did not drop sufficiently, and the combustible items in the trash can (e.g., paper scraps) were ignited.

When the cooling method was changed, the procedure manual was not changed; nor were checks conducted by the related parties, and hence, an on-site judgment was made rashly. Hence, the risk assessment of the work was insufficient.

6. How can this be prevented?

(1) Adopt a more reliable method for cooling the biomass after conducting the heating experiment as usual.

(2) Specify the following items as post-treatment (i.e., cooling) in the procedure manual for the biomass heating gasification experiment

1. Place the biomass after the heating experiment in the stainless steel container and cool it in the open air.
2. Check the temperature of the biomass using thermography or a thermometer.
3. Sprinkle water until the entire mass is soaked.
4. Confirm that any sign of fire is extinguished by the absence of bubbles or water vapor.
5. Store the mass in a heat-resistant container (heat-resistant trash can) in the laboratory for a week.
6. After the biomass has dried completely, dispose of it as combustible waste.

Note: If the temperature of the biomass or the stainless steel container is high, do not touch these objects with bare hands until the mass is cooled and the temperature is checked using thermography or a thermometer.

(3) Every year, ensure the risk assessment of potential risks is strictly conducted for each experiment to improve the awareness of those involved in conducting the experiment.

(4) Even for trivial changes in procedure, hold meetings with the people involved in the experiment, including the faculty members, and conduct risk assessments.

[On-site photographs]



Smoke was coming from the second trash can from the right.



Ignited garbage

Part of the paper waste and cardboard burned

Accident example 26	Contusion wounds of the fingers of left hand while dividing plate-shaped asphalt concrete debris by strike
Overview	While smashing the plate-shaped asphalt concrete debris onto the floor outdoors, fingers were caught between the debris and the floor, resulting in contusion wounds.

1. When?

After research experiment (weekday, around 4:00 p.m.)

2. Where?

Outside of Faculty Bldg. 4 (Mechanical Engineering and Civil Engineering)

3. What kind of accident occurred?

A student in the Civil and Environmental Engineering smashed the asphalt concrete debris onto the floor outdoors to dispose of the debris after cutting a cylindrical specimen from a plate-shaped asphalt concrete block. The three fingers of left hand were caught between the debris and the floor, resulting in contusion wounds. There were no fractures or infections.

4. How was this handled?

At the time of the accident, the student was working with two other students. The student was in severe pain and immediately ran to the physical education and storage center, but the nurse on duty was not there. So the student asked for help from Division of Student Affairs and explained the situation to the staff. The staff did medical examination procedures and the manager took and picked up to the medical institution. There is no abnormality on the bone, so the doctor treated with ointment and a bandage, and the student returned to the university.

5. What was the cause of the accident?

Although other work methods, such as smashing them with a large hammer or disposing of them without breaking them, could have been used, the students forcibly tried to rely solely on their own strength. In addition, the student themselves thought they could do the work.

6. How can this be prevented?

- (1) Provide safety guidance and safety education.
- (2) Compile and post the precautions for the experiment.
- (3) Provide safety instructions as a way of warning periodically.
- (4) Conduct risk assessment, make recognized the importance of risk prediction, and do training against possible danger.

[Circumstances at the time of accident]



Situation of accident scene



Plate-shaped asphalt concrete debris that caught fingers

Accident example 27	Ignition of tubular electric furnace rubber stoppers
Overview	While the tubular electric furnace was operating at 1000°C, silicone rubber stoppers at both ends of the mullite tube, which had Ar gas flowing through it, were heated and ignited.

1. When?

During an experiment in the laboratory (weekday, around 5:00 p.m.)

2. Where?

Extreme Energy-Density Research Institute

3. What kind of accident occurred?

While the tubular electric furnace was operating at 1000°C, silicone rubber stoppers at both ends of the mullite tube, which had Ar gas flowing through it, were heated and ignited.

The electric furnace and temperature control were commercially available, the wiring was self-made, and the temperature was measured with a K thermocouple at the port specified for the electric furnace. The measured value that visually confirmed when the power was turned off was 999°C, which was a good control for the setting of 1000°C.

4. How was this handled?

A student in another lab reported "smoke" and the student used a fire extinguisher to extinguish the fire.

No injuries and equipment damage.

5. What was the cause of the accident?

The silicone rubber stopper overheated because of a recent low-temperature heating experiment, in which a 600-mm-long mullite tube was used to heat the stopper to 1000°C. In addition, students had to leave the room for seminars and other activities after setting the timer and temperature to keep the temperature at the desired level.

6. How can this be prevented?

Take the following measures to prevent the silicone rubber stopper from overheating.

- (1) Replace with a mullite tube of 800 mm (special order) or 1000 mm (commercially available) longer than the 600 mm length in question.
- (2) To prevent further heating, add rock wool insulation to the silicone rubber stopper.
- (3) Remind students again at the regular annual safety education.

[Circumstances at the time of accident]



Tubular electric furnace



Silicone rubber stopper

Instructions regarding experiments conducted for unavoidable reasons over holidays or unmanned overnight

When conducting an experiment for unavoidable reasons over the holidays or overnight, please follow the instructions of the concerned faculty member and ensure that all measures are taken to prevent accidents.

- 1) In cases when an experiment or research needs to be conducted during the holidays due to unavoidable reasons, please pay attention to measures for safety, fire prevention, etc.**
 - Experiments are to be conducted strictly with the approval of the academic supervisor, and sufficient instructions should be received from the academic supervisor in advance.**

- 2) In cases when an experiment or research needs to be conducted all night without being manned for unavoidable reasons please pay attention to measures for safety, fire prevention, etc.**
 - Experiments are to be conducted strictly with the approval of the academic supervisor, and unmanned operation is not to be conducted when there is risk of danger.**
 - Ensure that the “notice for remaining after hours” and “unmanned operation all night” are posted on the entrance of the laboratory (please check p3 “Appendix 1 Procedures for after-hours experiments, etc.” for details).**

Seeking cases of “near misses”

Lessons from accidents

“In a workplace, for every accident that causes a major injury, there are 29 accidents that cause minor injuries and 300 accidents that cause no injuries.”

—Heinrich’s law—

“**Near miss**” is a dangerous situation that is on the verge of becoming an accident or “could lead to an accident”; for example,

- A gas cylinder falling and almost hitting one’s foot.
- A cardboard box falling from a locker and almost hitting one’s head.
- Almost getting run over by a car that was coming out of the parking lot when crossing the road on the premises.
- A fire almost spreading to paper when trying to burn a string with a lighter when disposing documents.

When encountering a “near miss” on campus,

please access the following URL and inform us of the details.

We will call attention in the campus and improve the facilities.

Students who belong to a laboratory should report to their **academic supervisor**.

Call for near-miss cases (Call for near-miss cases and reporting forms)

https://www.nagaokaut.ac.jp/gakunai/designated/jinji_romu/HIYARI/hiyarihat.html

Near-miss experiences (near-miss case studies top page)

https://www.nagaokaut.ac.jp/gakunai/designated/jinji_romu/HIYARI/top.html

Near-miss description example (posted at above URL)

Case 1	Chemicals that should not be drained down the sink were drained
Where	Laboratory
When	During protein expression analysis experiment
Summary	Chemicals that should not be drained down the sink (protein stain) were inadvertently discarded into it, and after quickly wiping down the sink with a paper towel and drying, the contents were discarded as combustible material.
Cause	Did not recall that this should not be put down the drain
Countermeasure	Thorough guidance by academic supervisors to prevent recurrence and efforts to call attention to the issue

Please be aware that it differs from the separation of household waste!

① Combustibles

Not allow to bring household garbage

paper, food scraps, wood chips etc.

Remove fasteners (metal) of paper files and put them to other materials.

* Food scraps should be drained, put in a bag, and fasten the mouth of the bag.

② Incombustibles

Bag of bread and sweets

plastic packaging materials

Tray

Disposable lunch box

Remove fasteners of Plastic files and put them to Other materials.

Plastic file

Plastic bowl and cup etc.

*** Leftover food is combustibles.**

*** Don't put leftover soup of cup noodles.**

③ Bottles

④ Plastic bottles

Cap of bottles is other materials (metal).

Not need to remove plastic label and cap.

⑤ Cans

* Cans that smell remains should be put in a bag, and fasten the mouth of the bag.

Other materials Glass, Metal, Spray can etc.

* Write materials' name on the bag and place it near other garbage box.

* Shredded waste or styrofoam etc. should be put in the bag, fasten the mouth of the bag, and place the side of the garbage boxes.

* Make a hole in the spray can except for written "Prohibition of making a hole".

* Wrap glass or fragile items in newspaper, put in a bag, and write "Glass".

Regarding cardboard and catalogs etc., tie up and carry them to the WASTE PAPER RECOVERY PLACE.

* Some department place it near garbage box on the 1st floor of building.

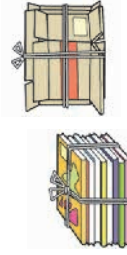

Handling of experimental waste

Follow the directions of supervisor at each laboratory and bring it to a SPECIAL DUMP

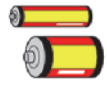

Place the batteries in a designated box or place them in a bag and take them to the Administration Office.

* **Excluding mercury-containing batteries**
(button batteries with air holes / part number initials NR or PR / mercury use specified)

Classification of Experiment-Related Waste *upper classification is applied as priority

Classification number and term*	Example of waste	Note
1. Quasi-Infectious Waste	<ul style="list-style-type: none"> Waste from the Physical Education and Health Care Center Syringes and Quasi-Syringe (glass or plastic) Needles 	<ul style="list-style-type: none"> Put needles into medical containers or particular metal containers for chemical experiments.
2A. Incombustible Experiment-Related Waste (Metals)	<ul style="list-style-type: none"> Metal products, pieces, polishing chips and cutting chips (volume upper limit of 18 liter cans) Metal foil (e.g., aluminum foil) Metal edged tools (e.g., scalpel) (limited to non-medical usage) Both washed and dried reagent cans 	<ul style="list-style-type: none"> Edged tools shall be shown clearly and carefully protected collection operator from injury. Metallic and nonmetallic composite material is classified as "2C".
2B. Incombustible Experiment-Related Waste (Glasses)	<ul style="list-style-type: none"> Glass products, pieces and chips Glass petri dishes and ampoules Both washed and dried glass reagent bottle <p>(No need to peel labels. Caps shall be removed and put into "3".)</p>	<ul style="list-style-type: none"> Glass and non-glass composite materials are classified as "2C".
2C. Incombustible Experiment-Related Waste (Other incombustible waste)	<ul style="list-style-type: none"> Ceramic products (e.g., crucibles), pieces and powders Concrete pieces (volume upper limit of garbage bag) and gypsum Other incombustible composite material Silica gel Desiccants (e.g., CaCl₂, MgSO₄, Na₂SO₄) 	<ul style="list-style-type: none"> Incombustible experiment-related waste other than "2A" and "2B". Commercial products and parts (e.g., broken machine) shall be put into domestic incombustible waste disposal.
3. Combustible Experiment-Related Waste	<ul style="list-style-type: none"> Papers (e.g., KimWipes, filter paper) Textile products (e.g., gauze, cotton wool) Plastic petri dishes, tubes, pipettes, and bottle caps Gloves (rubber or vinyl) Sterilized culture medium Autoclave sterilized combustible waste <p>(Use bag without biohazard symbol)</p> <ul style="list-style-type: none"> Both washed and dried plastic reagent container <p>(No need to peel labels. Caps shall be removed.)</p>	<ul style="list-style-type: none"> To prevent erroneous recognition as quasi-infectious waste, do not use bag with biohazard symbol when discharging autoclave sterilized combustible waste. Reagent and sample non-adherent papers and textile products shall be put into domestic combustible waste.

Waste from experiments applied for the table above shall put into the appointed garbage area. Waste not from experiments shall put into domestic waste disposal.
[Cautions]

- Attach NUT unified label (name of laboratory, date and classification are shown) on bags and cans when discharging experiment-related waste. (Format of NUT unified label is published in a web site. Each laboratory should download and print labels.)
- Penetrating sharp waste (e.g., pieces, chips) shall be discharged in solid containers.
- Reagent remained containers and unopened containers are collected by another professional service. Contact with the contract section of the division of financial affairs. (Collection service of experiment-related waste does not collect reagent remained containers.)

Flowchart of Experiment-Related Waste Classification

▪ Attach NUT unified label (name of laboratory, date and classification are shown) on bags and cans.

▪ Waste collection day is on the third Thursday of the month.

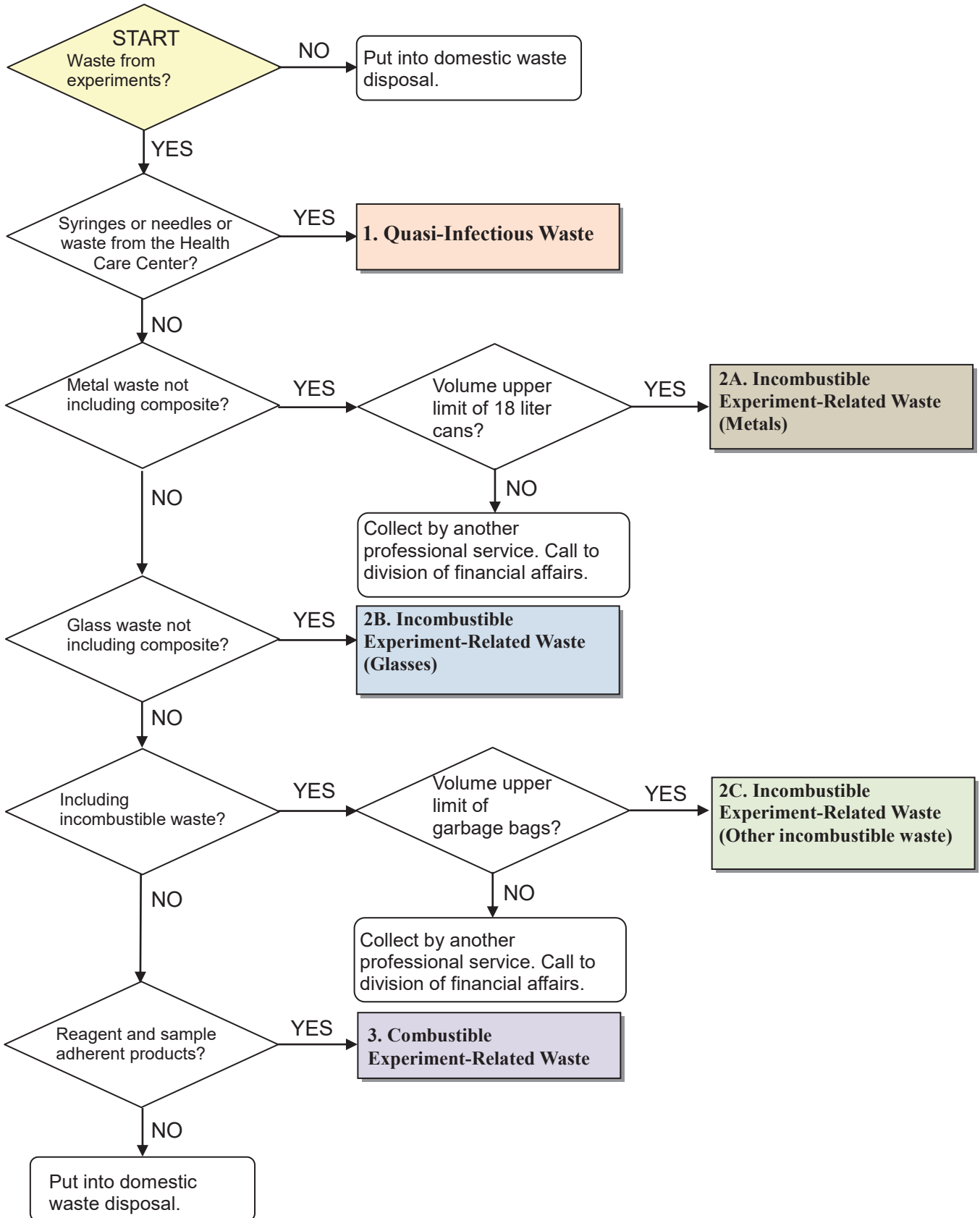

【 A 】			
Accessible emission limit	39	Cartagena Protocol	146
Acting alone	180,182	Cell fusion	146
AED	11,12,18	Clothing	1,17,21,25,42,56,66,76,88-90, 164,165,178,181,183
After-hours experiments	3,275	Combustible Laboratory Waste	139
Airway management	10	Contact system	5
Alarms	196	Containment measures	146-149
All-night unattended operation	3,25	Cranes	33,65
Alpha rays	158-160, 170	Cultured cells	146
Animal care and use committee	144	Cutting machine	61
Animal experiment(s)	143-145,148	Cylinder(s)	22,46-51,55,82,88,101,117, 122,129,187,191,194,276
Animal laboratory	145	Convulsions	9,17
Animal welfare	143	Chain blocks	65
Artificial respiration	1,10,11,17,36,51,89,90	City gas	34,44,71,100
Autoclave	52,139		
Avalanche(s)	178,184	【 D 】	
		Danger zone	181,182
【 B 】		Defibrillation	11
Band saw	62	Derricks	65
Beta rays	158-160,165,167,172	Designated quantity	78,83
Bleeding	9,13-16,124,154	Domestic wastewater	137
Broadcasting equipment	199	Discovery	2,211
Breeding	145,146	Disaster prevention	77,83,187,196,201
Bruise	13	Disaster prevention equipment	196
Burn(s)	9,13,16,17,30-34,37,38,62,63,91,92,95, 96,107,111-113,115,120,122,130,276	Diseases	144,145,149,154,179
		Dislocation(s)	9,13,15
【 C 】		Distress	89-91,144,183
Cardiac massage	1,11,17	Drifting	183

Drill(s)	59
Drilling machine(s)	58,64
Drum cord	28
Dry eye	210

【 E 】

Earthquake(s)	2,22,44,73,74,83,95,133,151, 179,180,187,190-194,199
Electrical work	27
Electrical discharge machine(s)	60
Electric shock(s)	1,17,27,28,30-34,38,41,43,60,62,86
Elevator(s)	2,7,54,55,191,196,199
Emergency resuscitation(s)	10,11,17
Evacuation	2,7,117,187,191,193-196,199
Experimental animal	143-145
Experimental liquid waste	74,137-139
Experimental waste	137-139
Experimental wastewater	137
Explosion limit(s)	50,51,97,101
Exposure(s)	24,39,41,73,76,85,89,90,92,119,122,124, 126,151,153-156,159,163,166,167,171, 173-175,203

【 F 】

Falling water	178,183
Fire alarm system	196
First aid	2,7,9,13,18,25,28,36,64,69,70,84,88,91, 178,183,184,193
Fire door equipment	199
Fire Service Act	69,70,74,78,82

Field experiment/practicum	
implementation plan	179
Fracture(s)	9,13,15,16
Freezer(s)	3,53
Fuse	27,30,33,34,36

【 G 】

Gamma rays	37,158-160
Gas leak(s)	2,48,50-53,101,122
Gas welding	62
Genetically modified organism	141,146,148
Glass badge	163,175
Grinder	60
Grinding machine(s)	59,64
Grindstone(s)	57,59-61
Ground collapse	184
Grounding	27,31-33,35
Ground wires	47

【 H 】

Halide fire extinguishing system	199
Hazardous materials storage	78,82
Hazardous materials handler qualification	77
Health management	43,138,181,209,210
High-pressure gas	22,46-49,52,53,71,101,187,194
Host vector system(s)	148,149
House collapse	184

【 I 】

IASO	69,70,72,74,76,77,90,133
Identification	7,149,172,180
Impaired consciousness	9,10,128

Incombustible Laboratory Waste	139
Indoor fire hydrant system	198
Industrial waste	138
Industrial Safety and Health Act	
	35,41,43,59-62,70,72,151,173,219
Infection control measures	141,142
Information equipment work	210
Insurance	179,180
Ionization	37,159,160

【 J 】

Japan Coast Guard	184
--------------------------	-----

【 L 】

Lathe(s)	58,64
Law(s)	
	28,46,53,69,71-73,78,93,94,96,98,118-120, 133,141,146,151-153,159,161-164,168, 171,172,176,181,214,219
Liquefied gas(es)	46,53-55,101
Liquid helium	55
Liquid nitrogen	54,55

【 M 】

Machining center(s)	57,60
Management system for lab chemicals	
	69,74,76,77,133
Meeting(s)	186,219,220
Microbial experiments	141
Milling machine(s)	58,64
MSDS	70

【 N 】

Natural environment	146,182
Neutron beam	159,160

【 O 】

Outdoor fire hydrant system	198
------------------------------------	-----

【 P 】

Permit(s)	143,179,180,182
Personal Accident Insurance for Students Pursuing Education and Research	179
Poisoning	
	9,17,51,71,89,91,105,122,124,126,128, 144,202
Poisonous and Deleterious Substances Control Act	19,69,71,72,119,132
Police	183,184
Power outage(s)	34,48,57,83,86
Physical containment	148,150
Press	2,14,60,171,172,198,199
Pressure gauge(s)	49-51,53
Pressure regulator(s)	48-51
Prevent falling	187-189
Protective glasses	40,42,56-58,60-63,84
PRTR system	69

【 Q 】

Quasi-Infectious Waste	139
-------------------------------	-----

【 R 】

Radiation	37,40,71,151-176,180,202
Radiation generator	151,152,159,162-164
Radioactivity	151,162,164
Radioisotope(s)	
	71,151,152,155,159,161,162,164-167, 169,171,172
Rainwater	137,138,190
Reagent bottles	138,139

Recombinant DNA Experiments	145,146,150	【 V 】	
		VDT work	206,209
Risk assessment(s)	70,72,73,75-77,219,220	【 W 】	
		Waste liquid	72,84,85
【 S 】		w-SDS	219,220
Safety first	177,178,180	【 X 】	
Safety shoes	56,66,178	X-ray workers	174
Saw(s)	61,62,64,207	X-ray equipment users	174,175
SDS	18,69-72,83,90,219,220	X-ray equipment use manager	174,175
Self-defense fire brigade	6,7	X-ray facility manager	174,175
Shearing	62	X-ray-generator(s)	173-175
Shielded metal arc welding	62	X-ray work chief	176
Sociality	182		
Special training for handling		【 Z 】	
low-voltage electricity	35	Zoonotic diseases	144
Specially controlled industrial waste	138		
Sprain(s)	15,213		
Student life guidebook	179		
Survey meter(s)	165,169,171,174		
【 T 】			
Tap water	23,44,45,97,129		
Thorium	153,168		
Traffic safety	181		
Transportation work	65		
Travel order inquiry	179		
Type 1 Radiation Protection Supervisor	176		
【 U 】			
Unnecessary waste reagents	138		
Uranium	119,120,134,153,160,168		

Safety Manual (2024 Edition)

Editing Safety and Health Management Committee
at Nagaoka University of Technology

Issued by Nagaoka University of Technology
〒940-2188
1603-1 Kamitomioka-machi, Nagaoka, Niigata
TEL 0258-47-9206
<https://www.nagaokaut.ac.jp/>

List of contact information in case of emergency

* Area code of Nagaoka City is “0258”.

(When using an extension phone, please do not forget to dial 0.)

		Contact point	Extension telephone	External telephone
Fire Theft Wind and flood damage	Energy Center		9290	(0258) 47-9290
	Manager, Division of Administrative Affairs		9200	47-9200
	Manager, Division of Financial Affairs		9210	47-9210
	Manager, Division of Facilities Affairs		9230	47-9230
Electricity / gas Elevator accidents	Energy Center		9290	47-9290
	Manager, Division of Facilities Affairs		9230	47-9230
	Senior Specialist, Division of Facilities Affairs		9232	47-9232
	Section of General Affairs		9232	47-9232
	Section of Electrical Affairs		9233	47-9233
	Section of Mechanical Affairs		9234	47-9234
Section of Architectural Affairs		9235	47-9235	
Other accidents / enquiries	Related to Students and Research Students	Manager, Division of Student Affairs	9250	47-9250
		Senior Specialist, Division of Student Affairs	9255	47-9255
		Senior Specialist, Division of Student Affairs	9284	47-9284
		Section of Student Affairs	9253	47-9253
		Section of Student Support	9256	47-9256
		Section of International Student Affairs	9285	47-9285
	Related to Contract Researchers, Joint Researchers, and Inland Researchers	Manager, Division of Academic Affairs	9240	47-9240
		Senior Specialist, Division of Academic Affairs	9241	47-9241
		Senior Specialist, Division of Academic Affairs	9242	47-9242
		Section of Academic Affairs	9243	47-9243
		Section of Student Affairs	9246	47-9246
		Section of Educational Exchange	9244	47-9244
	Related to Faculty Members and Staff	Manager, Division of Industry-Academia Cooperation and Research Promotion	9225	47-9225
		Senior Specialist, Division of Industry-Academia Cooperation and Research Promotion	9276	47-9276
		Senior Specialist, Division of Industry-Academia Cooperation and Research Promotion	9182	47-9182
Section of Research Support		9278	47-9278	
Section of External Funds		9277	47-9277	
Manager, Division of Administrative Affairs		9200	47-9200	
Senior Specialist, Division of Administrative Affairs	9201	47-9201		
Section of Administrative Affairs	9203	47-9203		
Administrator, Office of Personnel and Employee Affairs	9202	47-9202		
Section of Welfare and Employee Affairs	9926	47-9926		

- If the person you are trying to contact is not available, please contact another individual in the same frame.
- When reporting any incident to the fire department (ambulance), police station, or hospital, immediately notify the Manger of Administrative Affairs, Manager of Student Affairs, and Manager of Academic Affairs.
- When there is a need to contact a university staff member outside of working hours, please contact the Energy Center and ask staff home phone number.

Contact system in case of emergency

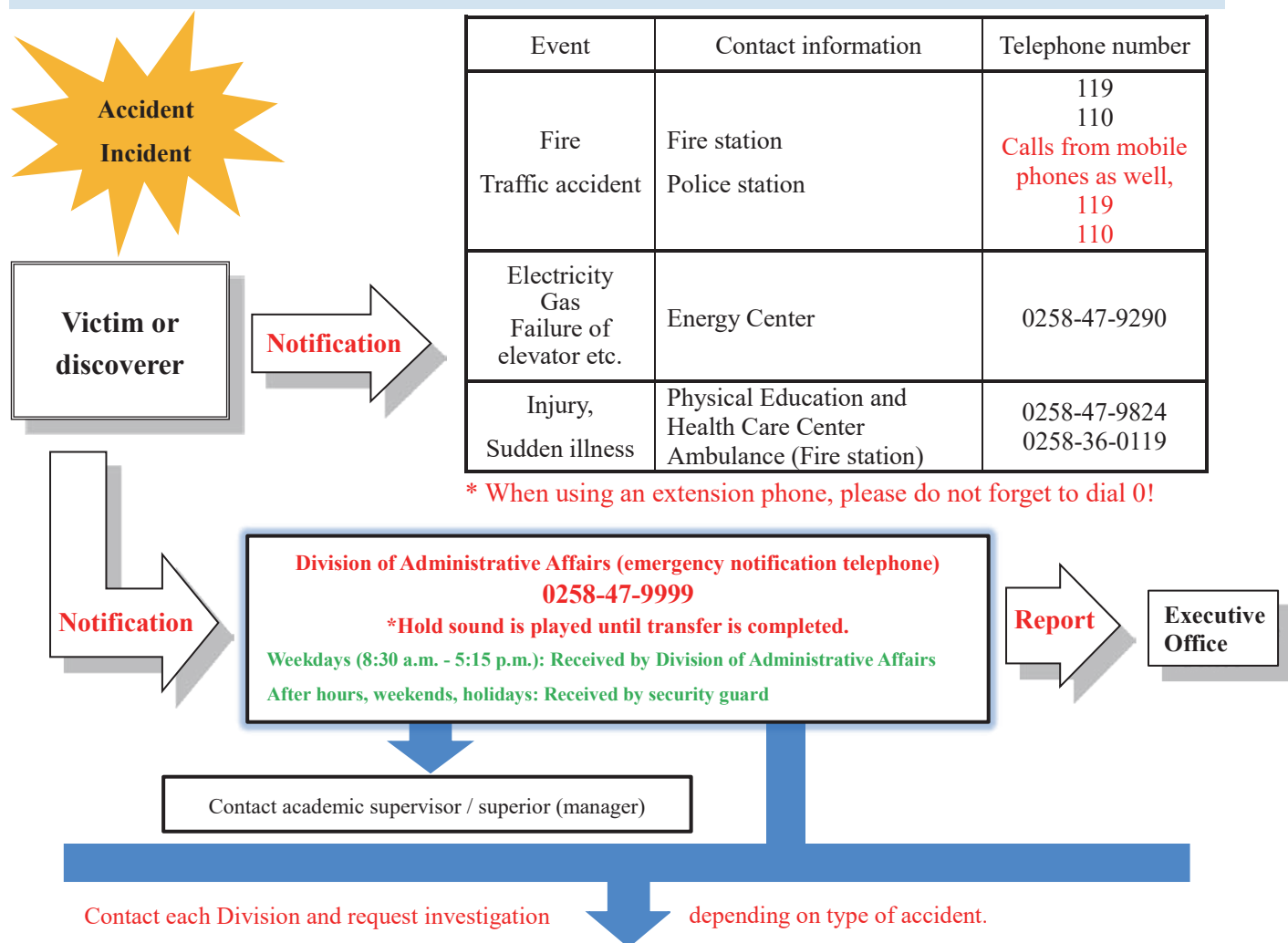

Classification	Overseeing division	Contact
Earthquakes, typhoons, heavy snow	Division of Administrative Affairs Division of Facilities Affairs	0258-47-9201, 9203 0258-47-9233, 9234
Fire, property damage	Division of Facilities Affairs	0258-47-9233, 9234
Suspicious persons, theft	Division of Administrative Affairs	0258-47-9201, 9203
Accidents during classes, experiments, etc.	Division of Academic Affairs	0258-47-9246, 9248
Accidents during outdoor activities, traffic accidents, student's misconduct	Division of Student Affairs	0258-47-9253
Student's food poisoning, sudden illness	Division of Student Affairs	0258-47-9253
Infection	Division of Administrative Affairs (faculty and staff) Division of Student Affairs (students)	0258-47-9926, 9206 0258-47-9253
Accidents while traveling abroad	Division of Administrative Affairs (faculty and staff) Division of Student Affairs (students)	0258-47-9201, 9203 0258-47-9243
Off-campus enquiries (news media etc.)	Office of Planning and Public Relations	0258-47-9016, 9207